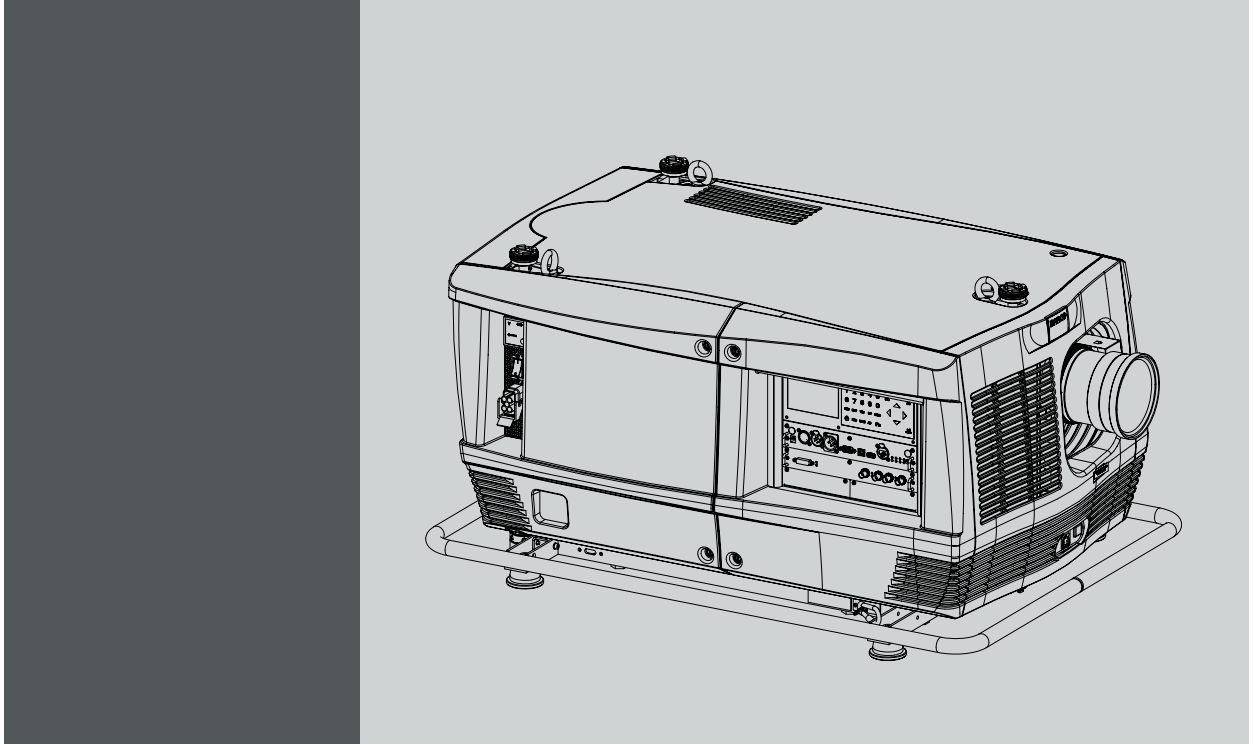


# HDF series



## User and Installation manual For HDF, HDF W22, HDF W26 and HDF W30 Flex

**Barco nv**  
Noordlaan 5, B-8520 Kurne  
Phone: +32 56.36.82.11  
Fax: +32 56.36.883.86  
Support: [www.barco.com/esupport](http://www.barco.com/esupport)  
Visit us at the web: [www.barco.com](http://www.barco.com)

Printed in Belgium

## Changes

Barco provides this manual 'as is' without warranty of any kind, either expressed or implied, including but not limited to the implied warranties or merchantability and fitness for a particular purpose. Barco may make improvements and/or changes to the product(s) and/or the program(s) described in this publication at any time without notice.

This publication could contain technical inaccuracies or typographical errors. Changes are periodically made to the information in this publication; these changes are incorporated in new editions of this publication.

The latest edition of Barco manuals can be downloaded from the Barco web site [www.barco.com](http://www.barco.com) or from the secured Barco web site <https://www.barco.com/en/signin>.

## Copyright ©

All rights reserved. No part of this document may be copied, reproduced or translated. It shall not otherwise be recorded, transmitted or stored in a retrieval system without the prior written consent of Barco.

## Trademarks

Brand and product names mentioned in this manual may be trademarks, registered trademarks or copyrights of their respective holders. All brand and product names mentioned in this manual serve as comments or examples and are not to be understood as advertising for the products or their manufacturers.

## EN55022/CISPR22 Class A ITE (Information Technology Equipment)

Class A ITE is a category of all other ITE which satisfies the class A ITE limits but not the class B ITE limits. Such equipment should not be restricted in its sale but the following warning shall be included in the instructions for use:

**Warning :** This is a class A product. In a domestic environment this product may cause radio interference in which case the user may be required to take adequate measures.

## Federal Communications Commission (FCC Statement)

This equipment has been tested and found to comply with the limits for a class A digital device, pursuant to Part 15 of the FCC rules. These limits are designed to provide reasonable protection against harmful interference when the equipment is operated in a commercial environment. This equipment generates, uses, and can radiate radio frequency energy and, if not installed and used in accordance with the instruction manual, may cause harmful interference to radio communications. Operation of this equipment in a residential area may cause harmful interference, in which case the user will be responsible for correcting any interference at his own expense

Changes or modifications not expressly approved by the party responsible for compliance could void the user's authority to operate the equipment



# TABLE OF CONTENTS

<b>1. Safety</b>	<b>7</b>
1.1 General considerations	7
1.2 Important safety instructions	8
1.3 Light beam Hazard Distance (HD)	10
1.4 HD in function of the lens Throw Ratio (TR)	11
1.5 Important warnings concerning HDF series flight cases	12
<b>2. Configurations, requirements and restrictions</b>	<b>13</b>
2.1 Installation requirements	13
2.2 Unpacking the projector	14
2.3 HDF series flight case	15
2.4 Projector configurations	16
2.5 Projector air inlets and outlets	19
2.6 Free download of Projector Toolset	19
2.7 Installation process overview	20
<b>3. Physical installation</b>	<b>21</b>
3.1 Remote control unit (RCU)	21
3.1.1 RCU battery installation	21
3.1.2 RCU rugged case installation	22
3.1.3 RCU XLR adaptor installation	23
3.1.4 Using the XLR adaptor of the RCU	23
3.1.5 RCU usage possibilities	24
3.2 Lenses	25
3.2.1 Available lenses	25
3.2.2 Lens selection	26
3.2.3 Lens installation	26
3.2.4 Lens removal	28
3.2.5 Lens safety cable	28
3.2.6 Lens shift, zoom & focus	30
3.2.7 Scheimpflug adjustment	31
3.3 Power connection	35
3.4 Suspension of the HDF series projector with rigging clamps	36
<b>4. Input &amp; Communication</b>	<b>41</b>
4.1 Introduction	41
4.2 Input source connections	42
4.3 Communication connections	44
<b>5. Getting started</b>	<b>49</b>
5.1 RCU & Local keypad	49
5.2 Terminology overview	49
5.3 Power on projector	51
5.4 Switching to standby	54
5.5 Power off projector	54
5.6 Status LEDs	54
5.7 Using the RCU	55
5.8 Projector Address	56
5.8.1 Displaying and Programming addresses into the RCU	56
5.8.2 Controlling the projector	56
5.9 Source selection	57
5.10 Alignment of a table mount HDF series projector	58
5.11 Alignment of a ceiling mount HDF series projector	58
<b>6. Quick set up adjustment</b>	<b>61</b>
6.1 Text boxes ON or OFF	61
6.2 Quick Lens Adjustment via LENS key	61
6.3 Direct Lens Adjustment (RCU)	63
6.4 Quick picture in picture	64
6.5 Quick language selection	64
<b>7. Start up of the adjustment mode</b>	<b>67</b>
7.1 About the adjustment mode	67
7.2 About the use of the remote control and the local keypad	67
7.3 Start up the adjustment mode	67
7.4 Navigation and adjustments	68
7.5 Menu memory	69
7.6 Shortcut keys to the menus	69
7.7 Test patterns in adjustment mode	70
7.8 Help information in adjustment mode	70
<b>8. Input</b>	<b>71</b>
8.1 Input menu overview	71

8.2	Input Selection .....	72
8.3	Advanced Settings .....	73
8.3.1	About Input Setup .....	73
8.3.2	Input configuration .....	73
8.3.3	DVI - RGB input .....	74
8.3.4	SDI input .....	75
8.3.5	5 cable input .....	76
8.3.6	HDMI - DisplayPort input (3D input module) .....	76
8.4	Input locking .....	77
8.5	Minimum delay .....	78
8.6	Native resolution .....	79
8.7	No Signal .....	80
8.7.1	Background color .....	80
8.7.2	Background Logo .....	81
8.7.3	Shutdown settings .....	82
8.7.4	Shutdown retarding time .....	82
8.7.5	Auto Dimming .....	83
8.8	EDID .....	84
8.8.1	Configure an input .....	84
8.8.2	Create custom EDID file .....	86
8.8.3	Delete a custom EDID file .....	87
8.8.4	Delete all custom EDID file .....	88
8.9	3D input .....	89
8.9.1	About 3D modes .....	89
8.9.2	Activate 3D .....	92
8.9.3	Auto detection .....	93
8.9.4	Input type selection .....	94
8.9.5	3D second input .....	95
8.9.6	L-R Synchronisation, field dominance .....	96
8.9.7	L-R Synchronisation, Invert 3D sync out .....	97
<b>9.</b>	<b>Image .....</b>	<b>101</b>
9.1	Image menu overview .....	101
9.2	Start up the Image adjustments .....	102
9.3	Image settings .....	102
9.3.1	Contrast .....	102
9.3.2	Brightness .....	103
9.3.3	Saturation .....	104
9.3.4	Phase .....	105
9.3.5	Color temperature (fixed values) .....	107
9.3.6	Color temperature (custom values) .....	108
9.3.7	Input Balance .....	109
9.3.7.1	Introduction to Input Balance .....	109
9.3.7.2	Adjusting the input balance .....	110
9.3.8	Image settings, defaults .....	113
9.4	Aspect Ratio .....	114
9.5	Timings .....	116
9.5.1	Source timings .....	116
9.5.2	Advanced timings, clamp delay - clamp width .....	117
9.6	Image File Services .....	119
9.6.1	Files and file manipulations .....	119
9.6.2	Manual Load file .....	119
9.6.3	File Load Filter .....	120
9.6.4	Delete a file .....	121
9.6.5	Delete all custom files .....	122
9.6.6	Rename custom files .....	123
9.6.7	Copy custom file .....	124
9.6.8	Image file service options, Load file .....	126
9.6.9	Image file service options, Auto Picture Alignment .....	126
9.7	Save custom settings .....	127
9.8	Splash image .....	128
<b>10.</b>	<b>Layout .....</b>	<b>131</b>
10.1	Layout menu overview .....	131
10.2	Introduction .....	131
10.3	Main window .....	132
10.3.1	Main window source selection .....	132
10.3.2	Main window size .....	132
10.3.3	Main window position .....	134
10.4	PiP window .....	135
10.4.1	Introduction to PiP .....	136
10.4.2	Picture in Picture activation .....	136
10.4.3	PiP window, source selection .....	137
10.4.4	PiP window, Size .....	138
10.4.5	PiP window, position .....	139
10.5	Layout File Services .....	141

10.5.1	Load layout file .....	141
10.5.2	Rename layout file .....	142
10.5.3	Delete layout file .....	143
10.5.4	Delete all layout files .....	144
10.5.5	Copy or Save as layout file .....	145
10.6	Lens behavior .....	146
<b>11.</b>	<b>Lamp .....</b>	<b>149</b>
11.1	Lamp menu overview .....	149
11.2	Lamp power mode .....	149
11.3	Lamp power .....	150
11.4	Auto dimming when on Pause .....	151
11.5	Auto dimming when No Signal .....	152
11.6	Auto dimming when Over-temperature .....	152
11.7	CLO mode (Constant light output mode) .....	153
11.8	CLO targets .....	155
11.9	LPS power .....	156
11.10	Lamp identification .....	156
11.11	Z-axis adjustment .....	157
<b>12.</b>	<b>Alignment .....</b>	<b>159</b>
12.1	Alignment menu overview .....	159
12.2	Orientation .....	160
12.3	Lens adjustment, zoom - focus .....	161
12.4	Lens adjustment, shift .....	162
12.5	Lens adjustment, mid position .....	163
12.6	Calibrate lens at startup .....	164
12.7	Calibrate lens .....	165
12.8	Warping .....	166
12.8.1	About warping .....	166
12.8.2	Warp activation - deactivation .....	167
12.8.3	Start up manual adjustment .....	167
12.8.4	Warp adjustment principle .....	169
12.8.5	Setting the warping level .....	171
12.8.6	Warp adaptation steps .....	171
12.8.7	Making selections and adjustments .....	172
12.8.8	Keystone correction workflow .....	173
12.8.9	Linearity adjustment, workflow .....	174
12.8.10	Selecting and changing the position of a specific point .....	175
12.8.11	Scaling the image .....	175
12.8.12	Shifting the image .....	176
12.8.13	Rotating the image .....	176
12.8.14	Hardware Reset .....	178
12.8.15	OSD opacity .....	178
12.8.16	Warp file service, load file .....	180
12.8.17	Warp file service, save to file .....	181
12.8.18	Warp file service, save as .....	181
12.8.19	Warp file service, rename file .....	182
12.8.20	Warp file service, delete file .....	183
12.8.21	Warp file service, delete all files .....	184
12.8.22	Warp board reset .....	185
12.8.23	Warp board and values reset .....	186
12.8.24	Alternative Side Keystone .....	187
12.9	Blanking adjustment .....	188
12.10	Contrast-Intensity .....	190
12.11	Gamma .....	191
12.12	Internal patterns .....	191
12.13	Color space .....	193
12.14	Scenergix .....	195
12.14.1	Introduction .....	195
12.14.2	Preparations .....	196
12.14.3	Scenergix activation .....	196
12.14.4	Scenergix pattern .....	196
12.14.5	Scenergix adjustment lines .....	197
12.14.6	Data doubling .....	198
12.14.7	White level adjustment (blending area) .....	200
12.14.8	Black level adjustment .....	203
12.14.9	Scenergix Reset .....	206
12.15	3D Glasses .....	207
12.15.1	Dark time adjustment .....	207
12.15.2	Left-right output reference delay .....	210
12.15.3	3D Sync Loop Through .....	211
12.16	High End Systems Mirror .....	212
<b>13.</b>	<b>Projector Control .....</b>	<b>215</b>
13.1	Projector Control menu overview .....	215

13.2	Individual Projector Address .....	216
13.3	Projector Common Address .....	217
13.4	Serial Communication .....	218
13.4.1	Baud rate setup .....	218
13.4.2	Interface Standard .....	218
13.5	Network .....	219
13.5.1	Introduction to a Network connection .....	219
13.5.2	Wired DHCP set up .....	220
13.5.3	Wired IP address set up .....	221
13.5.4	Wired subnet mask set up .....	222
13.5.5	Wired default gateway set up .....	224
13.5.6	Wireless network activation .....	225
13.5.7	Wireless access points selection and setup .....	226
13.5.8	Wireless DHCP set up .....	228
13.5.9	Wireless fixed IP address set up .....	229
13.5.10	Wireless subnet mask set up .....	230
13.5.11	Wireless default gateway set up .....	232
13.6	IR Control switching .....	233
13.7	DMX .....	234
13.7.1	DMX address .....	234
13.7.2	DMX universe .....	236
13.7.3	DMX mode .....	237
13.7.4	Art-Net DMX .....	238
13.7.5	Front XLR output voltage control .....	239
13.7.6	Monitor .....	241
13.7.7	DMX Shutdown .....	242
13.7.8	DMX Shutdown retarding time .....	243
13.8	Buttons .....	244
13.8.1	Standby button .....	244
13.8.2	Shortcut keys .....	245
13.9	Menu position .....	246
13.10	Local LCD .....	246
13.11	Language selection .....	247
13.12	Scheduler .....	248
13.12.1	Add a task to the list .....	249
13.12.2	Edit a task .....	252
13.12.3	Delete task .....	253
13.12.4	Scheduler, on or off .....	254
13.13	GSM Configuration, activation .....	255
13.14	GSM Configuration, subscription .....	257
13.15	FLEX, light output configuration .....	259
13.15.1	About FLEX, Light output control .....	259
13.15.2	Light output configuration via OSD menu .....	260
13.15.3	Configure projector's light output via SMS .....	261
13.16	SMS services .....	261
13.16.1	Request for notifications .....	261
13.16.2	Request for information .....	262
13.16.3	Lamp ignition admission .....	262
<b>14.</b>	<b>Service .....</b>	<b>263</b>
14.1	Service menu overview .....	263
14.2	Identification .....	264
14.3	Diagnosis .....	265
14.3.1	Versions .....	265
14.3.2	Measurements .....	266
14.3.3	Logging .....	268
14.3.4	Board Id .....	270
14.3.5	Notification .....	271
14.3.6	Tilt sensor .....	272
14.4	Internal Service Patterns .....	273
14.5	Convergence .....	277
14.6	Factory defaults .....	278
14.7	USB memory .....	279
14.8	Reset Formatter .....	281
14.9	Refill mode .....	281
14.10	Save Custom Settings .....	282
14.11	Special HD Camera mode .....	283
14.12	Auto Dimming when over-temperature .....	284
14.13	Time and Date .....	285
<b>15.</b>	<b>Maintenance .....</b>	<b>287</b>
15.1	Cleaning the lens .....	287
15.2	Cleaning the exterior of the projector .....	287
<b>16.</b>	<b>Removal and installation of the projector covers .....</b>	<b>289</b>
16.1	Removal of the front cover .....	289



---

16.2	Removal of the side cover.....	290
16.3	Removal of the lamp cover.....	291
16.4	Removal of the input cover.....	291
16.5	Installation of the front cover.....	292
16.6	Installation of the side cover.....	293
16.7	Installation of the lamp cover.....	294
16.8	Installation of the input cover.....	295
<b>17.</b>	<b>Servicing.....</b>	<b>297</b>
17.1	Inserting an input module.....	297
17.2	Replacement of the dust filter on the front side.....	298
17.3	Replacement of the dust filter on the bottom side.....	299
17.4	Replacement of the dust filter on the top side.....	300
17.5	Pressure verification of the liquid cooling circuit.....	301
17.6	Removal of the lamp house.....	302
17.7	Installation of the lamp house.....	303
17.8	Realignment of the lamp in its reflector.....	304
<b>A.</b>	<b>Specifications.....</b>	<b>307</b>
A.1	Specifications of the HDF W22.....	307
A.2	Specifications of the HDF W26.....	308
A.3	Specifications of the HDF W30 Flex.....	309
A.4	Technical Regulations.....	310
<b>B.</b>	<b>Dimensions.....</b>	<b>311</b>
B.1	Dimensions of the HDF series projector.....	311
B.2	Dimensions of the HDF series flight case.....	312
<b>C.</b>	<b>Standard source files.....</b>	<b>313</b>
C.1	Table overview.....	313
<b>D.</b>	<b>DMX chart.....</b>	<b>317</b>
D.1	DMX chart, Basic.....	317
D.2	DMX chart, Full.....	317
D.3	DMX chart, Extended.....	318
<b>E.</b>	<b>Stacking HDF series projectors.....</b>	<b>321</b>
E.1	Stacking HDF series projectors.....	321
E.2	Aligning stacked HDF series projectors.....	323
<b>F.</b>	<b>Environmental information.....</b>	<b>327</b>
F.1	Disposal information.....	327
F.2	Rohs compliance.....	327
F.3	Production address.....	329
F.4	Importers contact information.....	329



# 1. SAFETY

## About this chapter

Read this chapter attentively. It contains important information to prevent personal injury while installing and using a HDF series projector. Furthermore, it includes several cautions to prevent damage to the HDF series projector. Ensure that you understand and follow all safety guidelines, safety instructions and warnings mentioned in this chapter before installing your HDF series projector. After this chapter, additional "warnings" and "cautions" are given depending on the installation procedure. Read and follow these "warnings" and "cautions" as well.

## 1.1 General considerations



**WARNING:** Ensure you understand and follow all the safety guidelines, safety instructions, warnings and cautions mentioned in this manual.



**WARNING:** Be aware of suspended loads.



**WARNING:** Wear a hard hat to reduce the risk of personal injury.



**WARNING:** Be careful while working with heavy loads.



**WARNING:** Mind your fingers while working with heavy loads.



**CAUTION:** High pressure lamp may explode if improperly handled.

## General safety instructions

- Before operating this equipment please read this manual thoroughly and retain it for future reference.
- Installation and preliminary adjustments should be performed by qualified Barco personnel or by authorized Barco service dealers.
- All warnings on the projector and in the documentation manuals should be adhered to.
- All instructions for operating and use of this equipment must be followed precisely.
- All local installation codes should be adhered to.

## Notice on safety

This equipment is built in accordance with the requirements of the international safety standards IEC60950-1, EN60950-1, UL60950-1 and CAN/CSA C22.2 No.60950-1, which are the safety standards of information technology equipment including electrical business equipment. These safety standards impose important requirements on the use of safety critical components, materials and insulation, in order to protect the user or operator against risk of electric shock and energy hazard and having access to live parts. Safety standards also impose limits to the internal and external temperature rises, radiation levels, mechanical stability and strength, enclosure construction and protection against the risk of fire. Simulated single fault condition testing ensures the safety of the equipment to the user even when the equipment's normal operation fails.

## Users definition

Throughout this manual, the term SERVICE PERSONNEL refers to persons having appropriate technical training and experience necessary to be knowledgeable of potential hazards to which they are exposed (including, but not limited to HIGH VOLTAGE ELECTRIC and ELECTRONIC CIRCUITRY and HIGH BRIGHTNESS PROJECTORS) in performing a task, and of measures to minimize

## 1. Safety

---

the potential risk to themselves or other persons. The term USER and OPERATOR refers to any person other than SERVICE PERSONNEL, AUTHORIZED to operate professional projection systems.

A HDF series projector is intended "FOR PROFESSIONAL USE ONLY" by AUTHORIZED PERSONNEL familiar with potential hazards associated with high voltage, high intensity light beams, ultraviolet exposure and high temperatures generated by the lamp and associated circuits. Only qualified SERVICE PERSONNEL, knowledgeable of such risks, are allowed to perform service functions inside the product enclosure.

### 1.2 Important safety instructions

---

#### To prevent the risk of electrical shock

- This product should be operated from a mono phase AC power source.
- This apparatus must be grounded (earthed) via the supplied 3 conductor AC power cable. If none of the supplied power cables are the correct one, consult your dealer.  
If you are unable to insert the plug into the outlet, contact your electrician to replace your obsolete outlet. Do not defeat the purpose of the grounding-type plug.
- Do not allow anything to rest on the power cord. Do not locate this product where persons will walk on the cord. To disconnect the cord, pull it out by the plug. Never pull the cord itself.
- Use only the power cord supplied with your device. While appearing to be similar, other power cords have not been safety tested at the factory and may not be used to power the device. For a replacement power cord, contact your dealer.
- Do not operate the projector with a damaged cord. Replace the cord.  
Do not operate the projector if the projector has been dropped or damaged - until it has been examined and approved for operation by a qualified service technician.
- Position the cord so that it will not be tripped over, pulled, or contact hot surfaces.
- If an extension cord is necessary, a cord with a current rating at least equal to that of the projector should be used. A cord rated for less amperage than the projector may overheat.
- Never push objects of any kind into this product through cabinet slots as they may touch dangerous voltage points or short out parts that could result in a risk of fire or electrical shock.
- Do not expose this projector to rain or moisture.
- Do not immerse or expose this projector in water or other liquids.
- Do not spill liquid of any kind on this projector.
- Should any liquid or solid object fall into the cabinet, unplug the set and have it checked by qualified service personnel before resuming operations.
- Do not disassemble this projector, always take it to an authorized trained service person when service or repair work is required.
- Do not use an accessory attachment which is not recommended by the manufacturer.
- Lightning - For added protection for this video product during a lightning storm, or when it is left unattended and unused for long periods of time, unplug it from the wall outlet. This will prevent damage to the device due to lightning and AC power-line surges.

#### To prevent personal injury

- Isolate electrically before replacing the lamp or lamp house. Caution: Hot lamp (house).
- Caution: High pressure lamp may explode if improperly handled. Refer servicing to qualified service personnel.
- To prevent injury and physical damage, always read this manual and all labels on the system before inserting the lamp casing, connecting to the wall outlet or adjusting the projector.
- To prevent injury, take note of the weight of the projector. Minimum 4 persons are needed to carry the projector.
- To prevent injury, ensure that the lens and all covers are correctly installed. See installation procedures.
- Warning: high intensity light beam. NEVER look into the lens ! High luminance could result in damage to the eye.
- **Warning: extremely high brightness lamps:** This projector uses extremely high brightness lamps. Never attempt to look directly into the lens or at the lamp. If the projection distance is less than 6 meter, any person needs to be at least 4 meters away from the projected image. Avoid close range reflection of the projected image on any reflecting surface (such as glass, metal, ...) . When operating the projector, we strongly recommend wearing suitable safety glasses.
- Before attempting to remove any of the projector's covers, you must turn off the projector and disconnect from the wall outlet.
- When required to switch off the projector, to access parts inside, always disconnect the power cord from the power net.
- The power input at the projector side is considered as the disconnect device. When required to switch off the projector, to access parts inside, always disconnect the power cord at the projector side. In case the power input at the projector side is not accessible (e.g. ceiling mount), the socket outlet supplying the projector shall be installed nearby the projector and be easily accessible, or a readily accessible general disconnect device shall be incorporated in the fixed wiring.
- Never stack more than two (2) HDF series projectors in a hanging configuration (truss) and never stack more than three (3) HDF series projectors in a base stand configuration (table mount).
- When using the projector in a hanging configuration, always mount 2 safety cables. See installation manual for the correct use of these cables.
- Do not place this equipment on an unstable cart, stand, or table. The product may fall, causing serious damage to it and possible injury to the user.

- It is hazardous to operate without lens or shield. Lenses, shields or ultra violet screens shall be changed if they have become visibly damaged to such an extent that their effectiveness is impaired. For example by cracks or deep scratches.
- **Warning: Protection from ultraviolet radiation:** Do not look directly in the light beam. The lamp contained in this product is an intense source of light and heat. One component of the light emitted from this lamp is ultraviolet light. Potential eye and skin hazards are present when the lamp is energized due to ultraviolet radiation. Avoid unnecessary exposure. Protect yourself and your employees by making them aware of the hazards and how to protect themselves. Protecting the skin can be accomplished by wearing tightly woven garments and gloves. Protecting the eyes from UV can be accomplished by wearing safety glasses that are designed to provide UV protection. In addition to the UV, the visible light from the lamp is intense and should also be considered when choosing protective eye wear.
- **Exposure to UV radiation:** Some medications are known to make individuals extra sensitive to UV radiation. The American Conference of Governmental Industrial Hygienists (ACGIH) recommends occupational UV exposure for an 8 hour day to be less than 0,1 micro-watts per square centimeters of effective UV radiation. An evaluation of the workplace is advised to assure employees are not exposed to cumulative radiation levels exceeding these government guidelines. The exposer of this UV radiation is allowed for only 1 hour per day for maintenance and service persons.
- **Cooling liquid circuit.** The projector contains a cooling circuit filled with Blue antifreeze diluted (1/3 ethanediol – 2/3 Demi water).  
When the cooling circuit leaks, switch off the device and contact a service technician.  
The liquid is not for household use. Keep out of reach of children. Harmful by oral intake. Avoid exposure to pregnant women. Avoid contact with eyes, skin and clothing. Avoid inhale of the noxious fumes.
- When the projector is mounted above persons, mount always a lens safety cable.

### To prevent fire hazard

- Do not place flammable or combustible materials near the projector!
- Barco large screen projection products are designed and manufactured to meet the most stringent safety regulations. This projector radiates heat on its external surfaces and from ventilation ducts during normal operation, which is both normal and safe. Exposing flammable or combustible materials into close proximity of this projector could result in the spontaneous ignition of that material, resulting in a fire. For this reason, it is absolutely necessary to leave an "exclusion zone" around all external surfaces of the projector whereby no flammable or combustible materials are present. The exclusion zone must be not less than 40 cm (16") for all DLP projectors. The exclusion zone on the lens side must be at least 5 m. Do not cover the projector or the lens with any material while the projector is in operation. Keep flammable and combustible materials away from the projector at all times. Mount the projector in a well ventilated area away from sources of ignition and out of direct sun light. Never expose the projector to rain or moisture. In the event of fire, use sand, CO<sub>2</sub> or dry powder fire extinguishers. Never use water on an electrical fire. Always have service performed on this projector by authorized Barco service personnel. Always insist on genuine Barco replacement parts. Never use non-Barco replacement parts as they may degrade the safety of this projector.
- Slots and openings in this equipment are provided for ventilation. To ensure reliable operation of the projector and to protect it from overheating, these openings must not be blocked or covered. The openings should never be blocked by placing the projector too close to walls, or other similar surface. This projector should never be placed near or over a radiator or heat register. This projector should not be placed in a built-in installation or enclosure unless proper ventilation is provided.
- Projection rooms must be well ventilated or cooled in order to avoid build up of heat.
- Let the projector cool down completely before storing. Remove cord from the projector when storing.
- Heat sensitive materials should not be placed in the path of the exhausted air or on the lamp house.

### To prevent projector damage

- This projector has been designed for use with a specific lamp (house) type. See installation instructions for its correct type.
- The air filters of the projector must be cleaned or replaced on regular base (a "clean" booth would be monthly-minimum). Neglecting this could result in disrupting the air flow inside the projector, causing overheating. Overheating may lead to the projector shutting down during operation.
- The projector must always be installed in a manner which ensures free flow of air into its air inlets and unimpeded evacuation of the hot air from its cooling system.
- In order to ensure that correct airflow is maintained, and that the projector complies with Electromagnetic Compatibility (EMC) requirements, it should always be operated with all of it's covers in place.
- Slots and openings in the cabinet are provided for ventilation. To ensure reliable operation of the product and to protect it from overheating, these openings must not be blocked or covered. The openings should never be blocked by placing the product on a bed, sofa, rug, or other similar surface. This product should never be placed near or over a radiator or heat register. The device should not be placed in a built-in installation or enclosure unless proper ventilation is provided.
- Ensure that nothing can be spilled on, or dropped inside the projector. If this does happen, switch off and unplug the mains supply immediately. Do not operate the projector again until it has been checked by qualified service personnel.
- Do not block the projector cooling fans or free air movement around the projector. Loose papers or other objects may not be nearer to the projector than 10 cm (4") on any side.
- Do not use this equipment near water.
- **Special care for Laser Beams:** Special care should be used when DLP projectors are used in the same room as high power laser equipment. Direct or indirect hitting of a laser beam on to the lens can severely damage the Digital Mirror Devices™ in which case there is a loss of warranty.
- Never place the projector in direct sun light. Sun light on the lens can severely damage the Digital Mirror Devices™ in which case there is a loss of warranty.
- Save the original shipping carton and packing material. They will come in handy if you ever have to ship your equipment. For maximum protection, repack your set as it was originally packed at the factory.

## 1. Safety

---

- Unplug this product from the wall outlet before cleaning. Do not use liquid cleaners or aerosol cleaners. Use a damp cloth for cleaning. Never use strong solvents, such as thinner or benzine, or abrasive cleaners, since these will damage the cabinet. Stubborn stains may be removed with a cloth lightly dampened with mild detergent solution.
- To ensure the highest optical performance and resolution, the projection lenses are specially treated with an anti-reflective coating, therefore, avoid touching the lens. To remove dust on the lens, use a soft dry cloth. Do not use a damp cloth, detergent solution, or thinner.
- Rated maximum ambient temperature,  $t_a = 40\text{ }^\circ\text{C}$  (104 °F).
- The lamp house shall be replaced if it has become damaged or thermally deformed.

### On servicing

- Do not attempt to service this product yourself, as opening or removing covers may expose you to dangerous voltage potentials and risk of electric shock.
- Refer all servicing to qualified service personnel.
- Attempts to alter the factory-set internal controls or to change other control settings not specially discussed in this manual can lead to permanent damage to the projector and cancellation of the warranty.
- Unplug this product from the wall outlet and refer servicing to qualified service technicians under the following conditions:
  - When the power cord or plug is damaged or frayed.
  - If liquid has been spilled into the equipment.
  - If the product has been exposed to rain or water.
  - If the product does not operate normally when the operating instructions are followed. Adjust only those controls that are covered by the operating instructions since improper adjustment of the other controls may result in damage and will often require extensive work by a qualified technician to restore the product to normal operation.
  - If the product has been dropped or the cabinet has been damaged.
  - If the product exhibits a distinct change in performance, indicating a need for service.
- Replacement parts: When replacement parts are required, be sure the service technician has used original Barco replacement parts or authorized replacement parts which have the same characteristics as the Barco original part. Unauthorized substitutions may result in degraded performance and reliability, fire, electric shock or other hazards. Unauthorized substitutions may void warranty.
- Safety check: Upon completion of any service or repairs to this projector, ask the service technician to perform safety checks to determine that the product is in proper operating condition.
- Possible explosion hazard: Always keep in mind the caution below:



**CAUTION: Xenon compact arc lamps are highly pressurized. When ignited, the normal operating temperature of the bulb increases the pressure to a level at which the bulb may explode if not handled in strict accordance to the manufacturer's instructions. The bulb is stable at room temperature, but may still explode if dropped or otherwise mishandled. Whenever the lamp house, containing a xenon lamp, has to be dismantled or whenever the protective container or cloth has to be removed from the xenon lamp, authorized protective clothing MUST be worn!**

---

### To prevent battery explosion

- Danger of explosion if battery is incorrectly installed.
- Replace only with the same or equivalent type recommended by the manufacturer.
- For disposal of used batteries, always consult federal, state, local and provincial hazardous waste disposal rules and regulations to ensure proper disposal.

## 1.3 Light beam Hazard Distance (HD)

---



### HD

Light beam Hazard Distance (HD) is the distance from the source at which the intensity or the energy per surface unit becomes lower than the applicable safety limit. The light beam can thus be considered as dangerous if the operator is closer from the source than the HD.

---

### Restriction Zone (RZ) based on the HD

The HD is defined from the projection lens surface towards the position of the lowest projected beam where the irradiance equals the applicable safety limit. The HD depends on the amount of lumens produced by the projector and the type of lens installed. See next chapter *HD in function of the lens Throw Ratio (TR)*.

To protect untrained users the installation shall comply with the following installation requirements: light output levels in excess of the limits shall not be permitted at any point less than 2.0 meters (SH image 1-1) above any surface upon which persons are assumed to stand or 1 meter (SW image 1-1) below or in lateral separation from any place where such persons are assumed to be. See image 1-1.

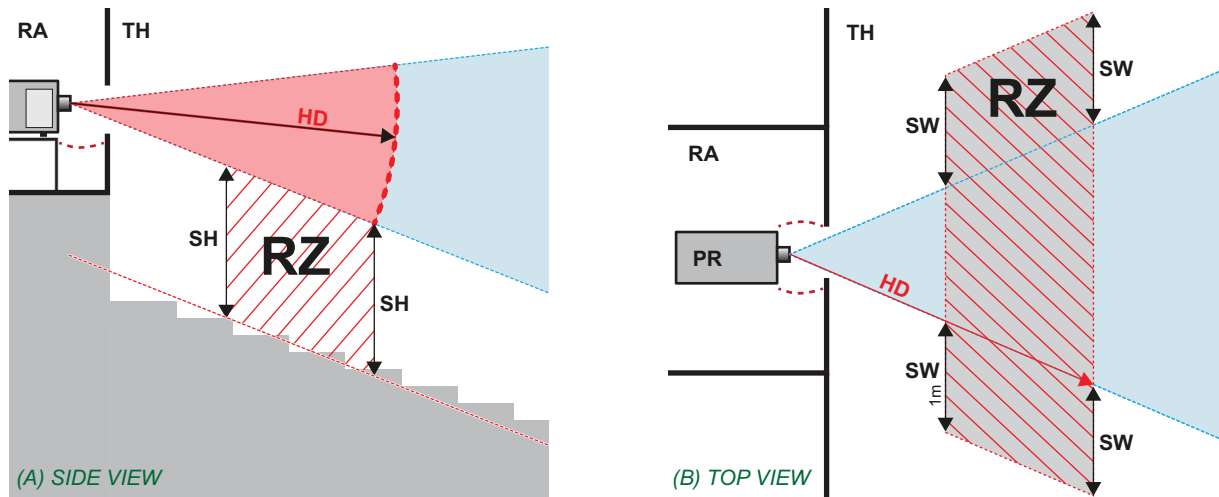


Image 1-1  
 A Side view.  
 B Top view.  
 RA Restricted Access location (boot area of projector).  
 PR Projector.  
 TH Theater.  
 RZ Restriction Zone in the theater.  
 SH Separation Height. Must be minimum 2 meter.  
 SW Separation Width. Must be minimum 1 meter.

Based on national requirements, no person is allowed to enter the projected beam within the zone between the projection lens and the related hazard distance (HD). This shall be physically impossible by creating sufficient separation height or by placing barriers. The minimum separation height takes into account the surface upon which persons are assumed to stand.

On image 1-1 a typical setup is displayed. It must be verified by the installer if these minimum requirements are met. If required a restricted zone (RZ) in the theater must be established. This can be done by using physical barrier, like a red rope as illustrated in image 1-2.

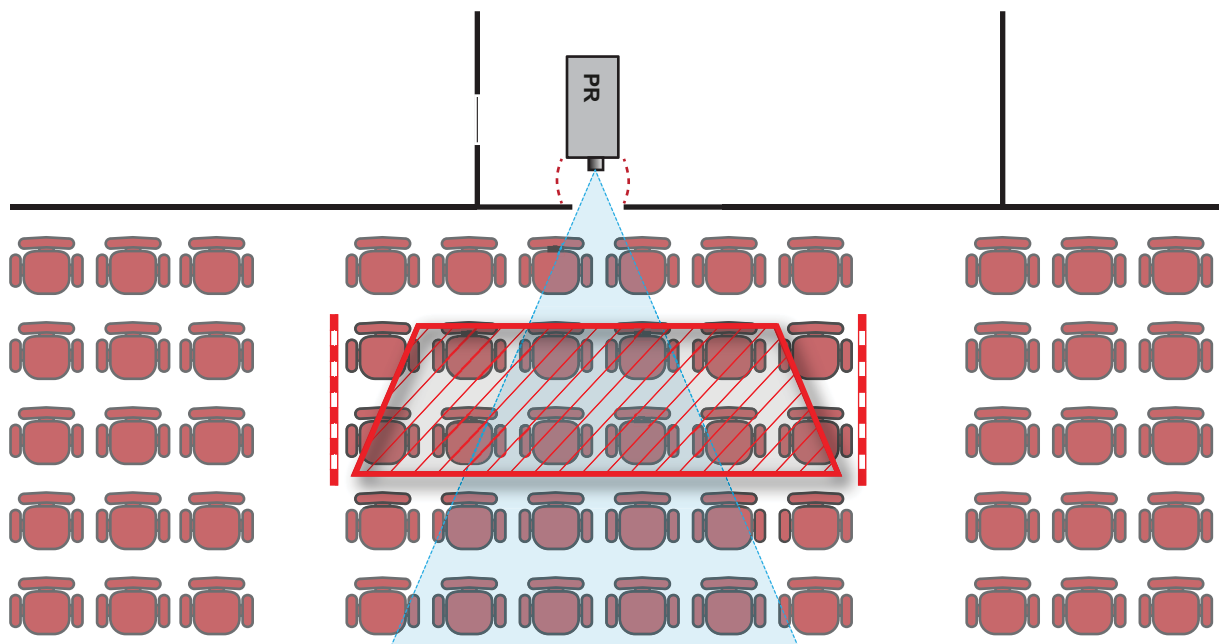


Image 1-2

## 1.4 HD in function of the lens Throw Ratio (TR)



### TR (Throw Ratio)

The ratio of the distance to the screen (throw) to the screen width.

## HDF series projector Hazard Distance

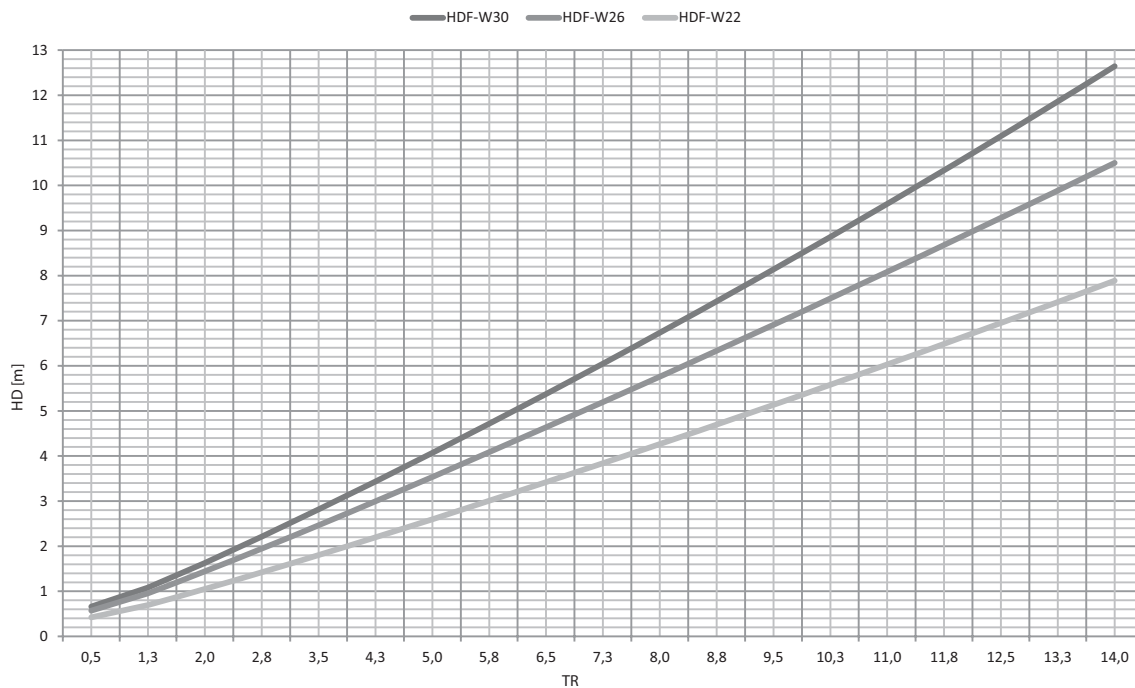


Image 1-3  
HD (in meter) in function of the Throw Ratio (TR)

## 1.5 Important warnings concerning HDF series flight cases

### Important warnings concerning stacking/transporting HDF series rental flight cases

- Stack maximum two (2) HDF series rental flight cases high. Never higher.
- Surface on which flight case is standing must be level to ensure that the total load is evenly spread out among the four wheels. The surface must also be able to support the load safely.
- Before stacking or transporting flight cases, check the wheels and their fixation screws for wear or defects.
- Before stacking or transporting flight cases, check that the four lock handles on each flight case are in good working order and locked securely.
- When stacked, make sure the wheels of the upper flight case are precisely positioned in the stacking dishes of the flight case below.
- Stacked flight cases may not be moved. Before stacking, the lower flight case must already be in its final resting position before placing the second upon it.
- Never stack loaded flight cases in a truck or other transport medium, unless each flight case is rigidly strapped tight.
- In the event of a wheel breaking, flight cases must be rigidly strapped tight to prevent a stack collapsing.
- Use an appropriate forklift to raise flight cases and take the necessary precautions to avoid personnel injury.



## 2. CONFIGURATIONS, REQUIREMENTS AND RESTRICTIONS

### About this chapter

Read this chapter before installing your HDF series projector. It contains important information concerning installation requirements and restrictions for the HDF series projector, such as minimum and maximum allowed ambient temperature, humidity conditions, required safety area around the installed projector, required power net, tilt, etc.

Furthermore, careful consideration of things such as image size, ambient light level, projector placement and type of screen to use are critical to the optimum use of the projection system.

### Overview

- Installation requirements
- Unpacking the projector
- HDF series flight case
- Projector configurations
- Projector air inlets and outlets
- Free download of Projector Toolset
- Installation process overview

## 2.1 Installation requirements

### Environment conditions

Table below summarizes the physical environment in which the HDF series projector may be safely operated or stored.

Environment	Operating	Non-Operating
Ambient Temperature	10 °C (50 °F) to 40 °C (104 °F)	-15°C (5°F) to 60°C (140°F)
Humidity	5% to 85% RH Non-condensed	5% to 95% RH Non-Condensed
Altitude	-60 (-197Ft) to 3000m (9843Ft)	-60 (-197Ft) to 10000m (32810Ft)



**Let the projector acclimatize after unpacking. Neglecting this may result in a startup failure of the Light Processor Unit.**

### Cooling requirements

The projector is fan cooled and must be installed with sufficient space around the projector head, minimum 10 cm (4 inch) to ensure sufficient air flow. It should be used in an area where the ambient temperature, as measured at the projector air inlet, does not exceed +40 °C (104 °F).

### Clean air environment

A projector must always be mounted in a manner which ensures the free flow of clean air into the projectors ventilation inlets. For installations in environments where the projector is subject to airborne contaminants such as that produced by smoke machines or similar (these deposit a thin layer of greasy residue upon the projectors internal optics and imaging electronic surfaces, degrading performance), then it is highly advisable and desirable to have this contamination removed prior to it reaching the projectors clean air supply. Devices or structures to extract or shield contaminated air well away from the projector are a prerequisite, if this is not a feasible solution then measures to relocate the projector to a clean air environment should be considered.

Only ever use the manufacturer's recommended cleaning kit which has been specifically designed for cleaning optical parts, never use industrial strength cleaners on the projector's optics as these will degrade optical coatings and damage sensitive optoelectronics components. Failure to take suitable precautions to protect the projector from the effects of persistent and prolonged air contaminants will culminate in extensive and irreversible ingrained optical damage. At this stage cleaning of the internal optical units will be noneffective and impracticable. Damage of this nature is under no circumstances covered under the manufacturer's warranty and may deem the warranty null and void. In such a case the client shall be held solely responsible for all costs incurred during any repair. It is the clients responsibility to ensure at all times that the projector is protected from the harmful effects of hostile airborne particles in the environment of the projector. The manufacturer reserves the right to refuse repair if a projector has been subject to knowingly neglect, abandon or improper use.

### Main Power requirements

The HDF series projector operates from a nominal mono phase power net with a separate earth ground PE.

## 2. Configurations, requirements and restrictions

Projector	Power requirements
HDF W22	200-240VAC, 50-60Hz, 24A at 200 VAC
HDF W26	200-240 VAC, 50-60Hz, 24A at 200 VAC
HDF W30 Flex	200-240 VAC, 50-60Hz, 24A at 200 VAC

The power cord required to connect the projector with the power net is delivered with the projector.

### Projector weight

Do not underestimate the weight of the HDF series projector. The projector weights about  $\pm 100$  kg ( $\pm 225$  lb.) without lens. Be sure that the pedestal on which the projector has to be installed is capable of handling five (5) times the complete load of the system.

## 2.2 Unpacking the projector

### What has to be done ?

At delivery the projector is packed in a carton box upon a wooden pallet and secured with banding and fastening clips. Furthermore, to provide protection during transportation, the projector is surrounded with foam. Once the projector is arrived at the installation site, it has to be removed from the carton box and wooden pallet in a safe manner without damaging the projector.

### Necessary tools

- Side cutter.
- 8 mm Allen key.

### How to unpack the projector ?

1. Remove the banding around the carton box, by releasing the fastening clips as illustrated, and remove the top cover.

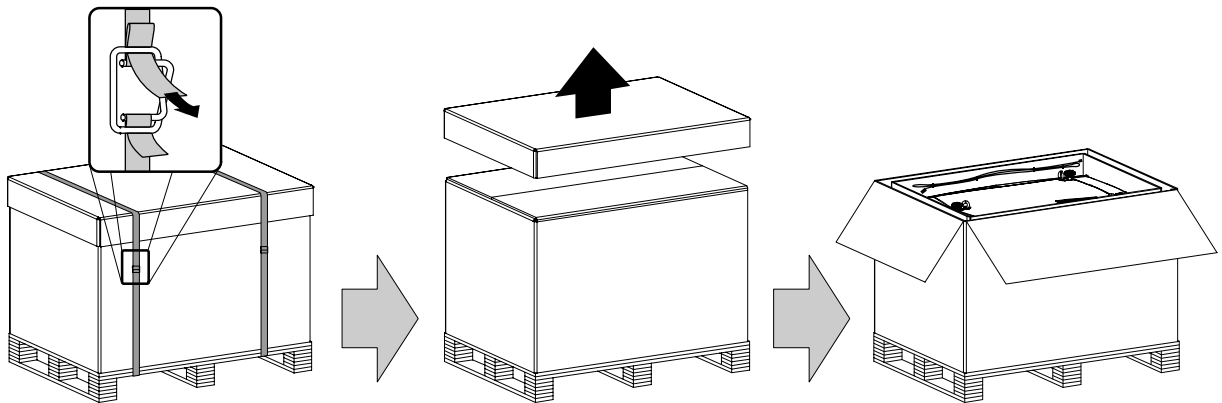


Image 2-1

2. Remove the power cord, which is attached to the packaging with a cable ties, and the two smaller carton boxes, located between the inner carton sleeve and outer carton box.

**Note:** The two smaller carton boxes contain the manuals, the remote control unit (RCU), two standard batteries size AA and four rigging clamps for projector suspension.

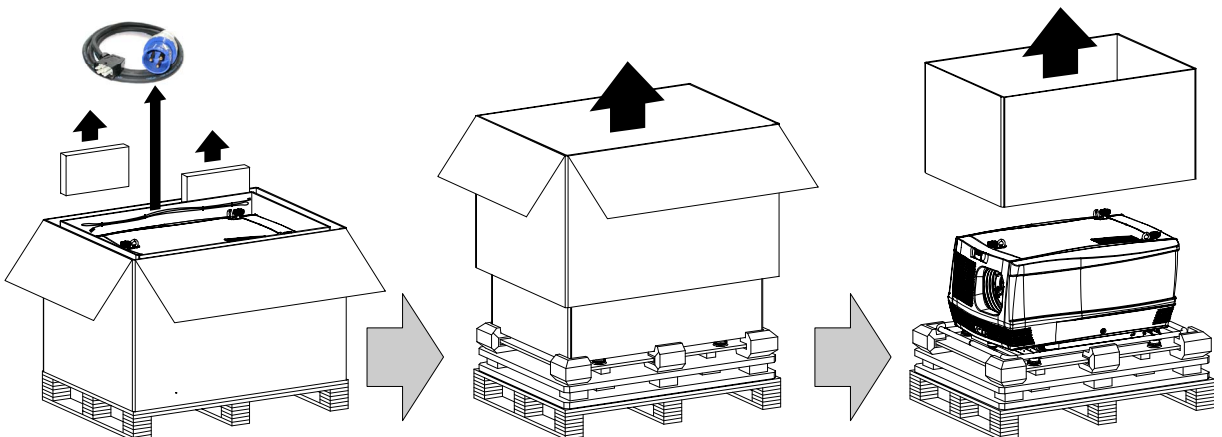


Image 2-2

- Remove the carton box, the inner carton sleeve and the foam around the projector. See image 2-2.

**Note:** The projector is still attached to a wooden plate, which is detached from the below pallet.

- Gently turn the projector upside down to gain access to the four bolts, which secure the projector. Note that this wooden plate is detached from the pallet.

**Tip:** Lay a blanket (or the earlier removed foam) on the floor to protect the projector housing from scratches while turning.

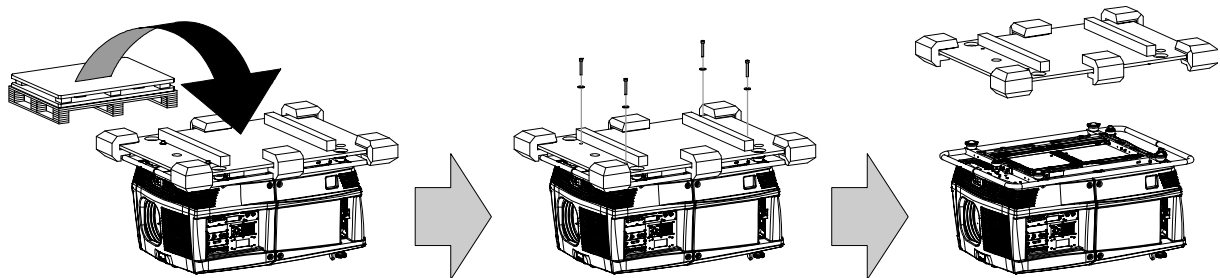


Image 2-3

- Remove the wooden plate from the projector bottom, by releasing the four bolts. Use an 8 mm Allen key. See image 2-3.

- Gently turn the projector back on its feet.

- Remove the foam rubber around the carrying handle.



**Save the original shipping carton and packing material, they will be necessary if you ever have to ship your projector. For maximum protection, repack your projector as it was originally packed at the factory.**



**A rubber foam inside a plastic bag is placed into the lens opening of the projector. It's recommended to reuse this foam and plastic back each time you transport the projector. This to prevent intrusion of dust and foreign particles.**

## 2.3 HDF series flight case

### Introduction of the HDF series flight case

The HDF series flight case is designed to transport the HDF series projector in a safe and secure manner. The four caster wheels, provided with breaks, and the eight handles make the HDF series flight case easy to handle. The floor of the flight case wagon is equipped with two small covered compartments to store the remote control and the rigging clamps. Furthermore, three Velcro strips are attached to the bottom for fastening the power cord of the projector.

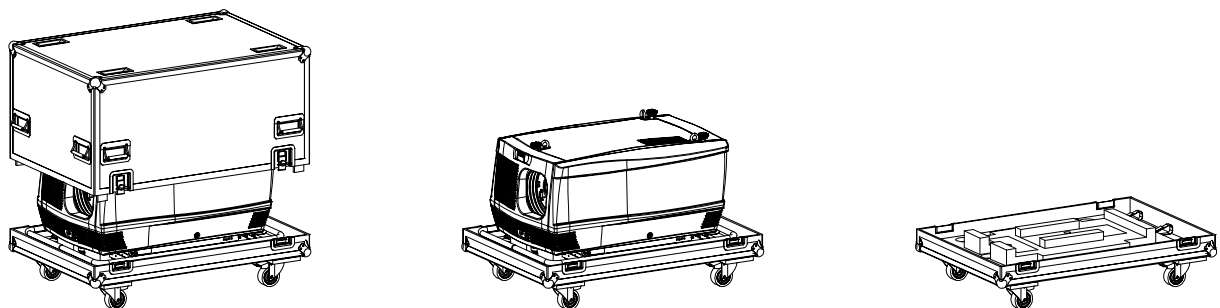


Image 2-4  
HDF series flight case (R9854510).

The dimensions of the HDF series flight case are optimal for maximum utilization of the floor area of a truck. The cover of the HDF series flight case has four stacking dishes, which allows to stack the flight cases.

## 2. Configurations, requirements and restrictions

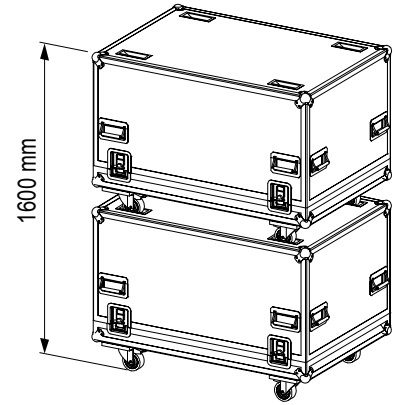
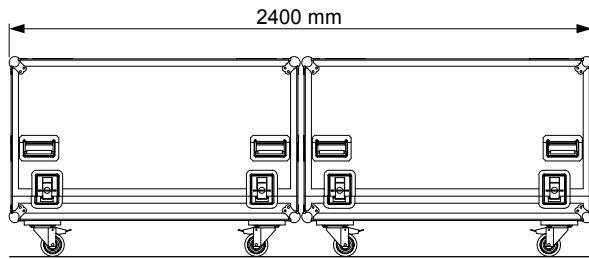


Image 2-5



**WARNING:** Maximum stack two (2) HDF series flight cases high. Never higher.



**CAUTION:** Prior to inserting projector in flight case turn in the adjustable feet and interlocking adapters fully.

## 2.4 Projector configurations

### The different configurations

Depending on the installation the projector can be mounted in different ways, the 4 different configurations are:

1. Front / Table (F/T)
2. Front / Ceiling (F/C)
3. Rear / Table (R/T)
4. Rear / Ceiling (R/C)

### Front projection

The projector is installed, either in a table mount or ceiling mount configuration, at the same side of the screen as the audience.

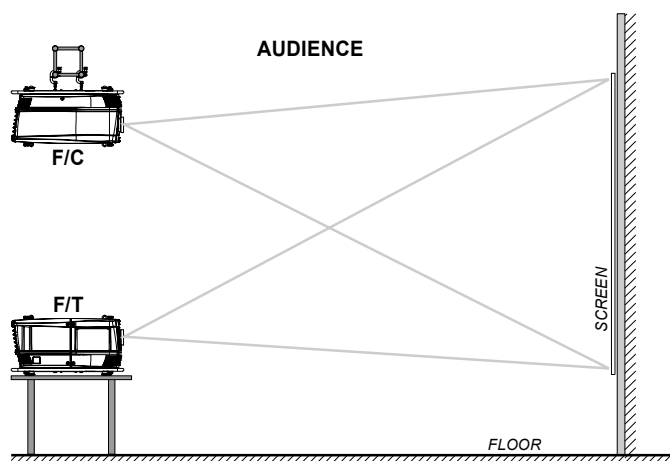


Image 2-6  
Front projection

### Rear projection

The projector is installed, either in a table mount or ceiling mount configuration, at the other side of the screen opposite the audience.

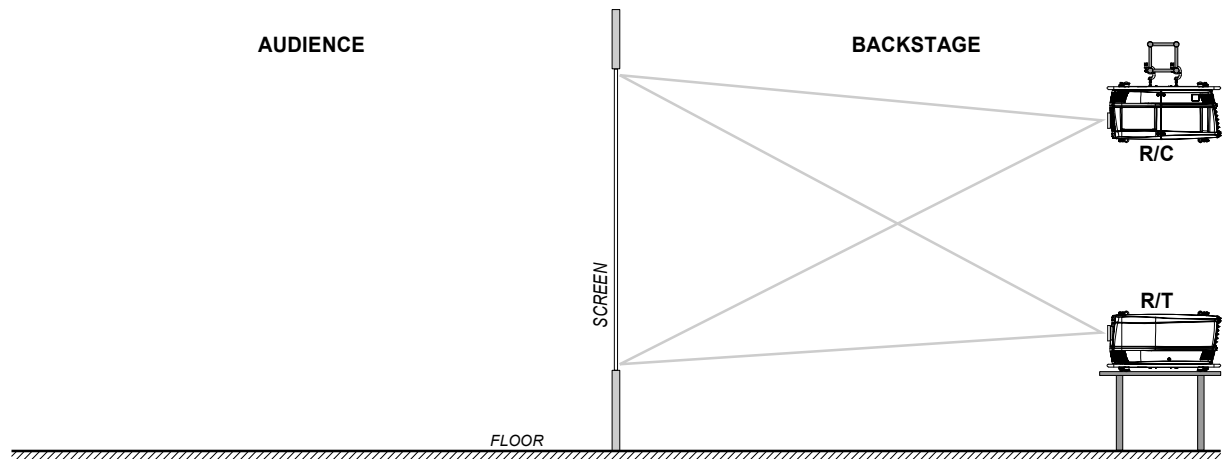


Image 2-7  
Rear projection

### Positioning the projector

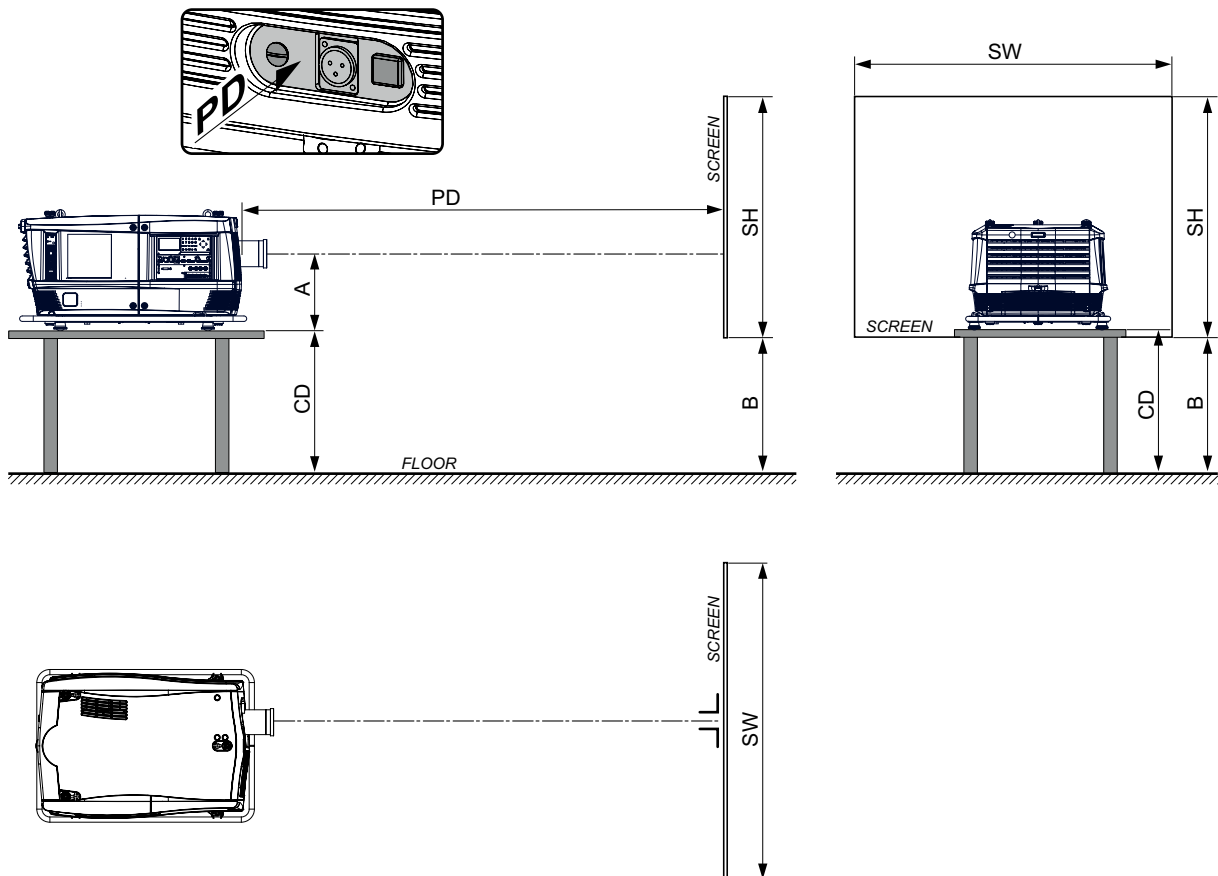


Image 2-8  
Projector positioning

The projector should be installed at right angles (horizontally and vertically) to the screen at a distance PD. Note the distance (A) between lens centre and table surface is slightly variable. This distance (A) is nominal 35 cm in case all feet are turned in completely and the vertical lens shift is set to zero (0).

### On-Axis / Off-Axis projection

The position of the projector with reference to the screen may also be different depending on the installation. Basically the projector can be positioned in On-Axis or Off-Axis configuration. On-Axis configuration means that the projector is positioned so as to have the centre of the lens coinciding with the centre of the screen. Off-Axis projection is obtained by shifting the lens up, down, left or right. Several parameters can be calculated determining the position in any installation.

Formula to calculate the distance CD for On-Axis projection:  $CD = SH/2 + B - A$

**Shift range**

The lens can be shifted with respect to the DMD (P) which result in a shifted image on the screen (Off-Axis). A 100% shift means that the centre point of the projected image is shifted by half the screen size. In other words, the centre point of the projected image falls together with the outline of the image in an On-Axis projection. Due to mechanical and optical limitations it's recommended to keep the shift values within the field of view (F) as illustrated below. Within these shift ranges the projector and lens perform excellently. Configuring the projector outside these shift ranges will result in a slight decline of image quality.

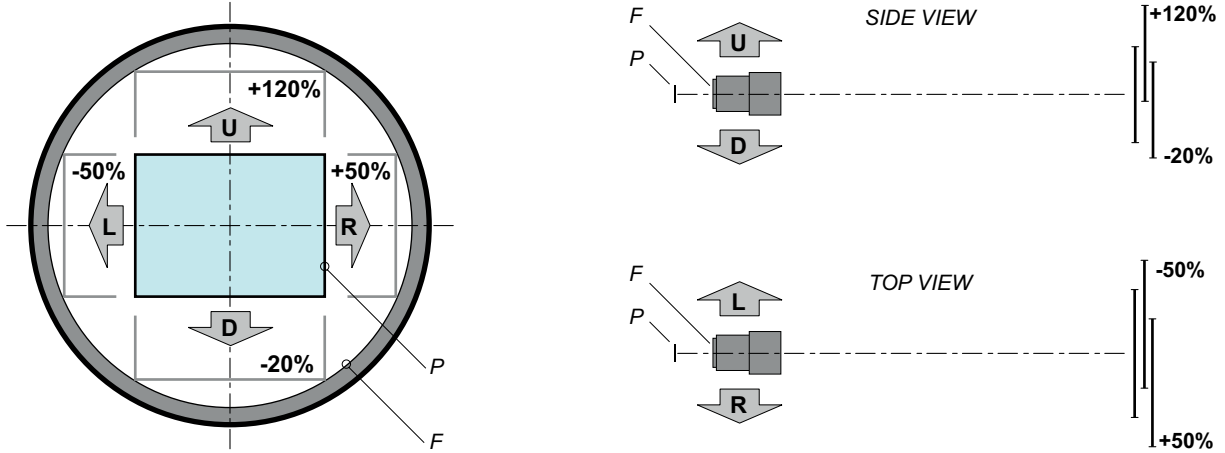



Image 2-9  
Vertical and horizontal shift range

- P DMD.
- F Field of view.

 It is mechanical possible to shift outside the recommended field of view, but it will result in a decline of image quality depending on the used lens and the zoom position of the used lens. Furthermore, shifting too much in both directions will result in a blurred image corner.

 Best image quality is projected in the On-Axis configuration.

**Horizontal and vertical projector tilt ranges**

The projector can be rotated and mounted at any vertical angle. In other words, you can tilt the lens side of the projector as much as desired for your application. Side to side tile, however, must not exceed  $\pm 15^\circ$ . This limit ensures that the lamp in the projector operates properly and safely. More tilting within area C is allowed but lamp flicker can happen.

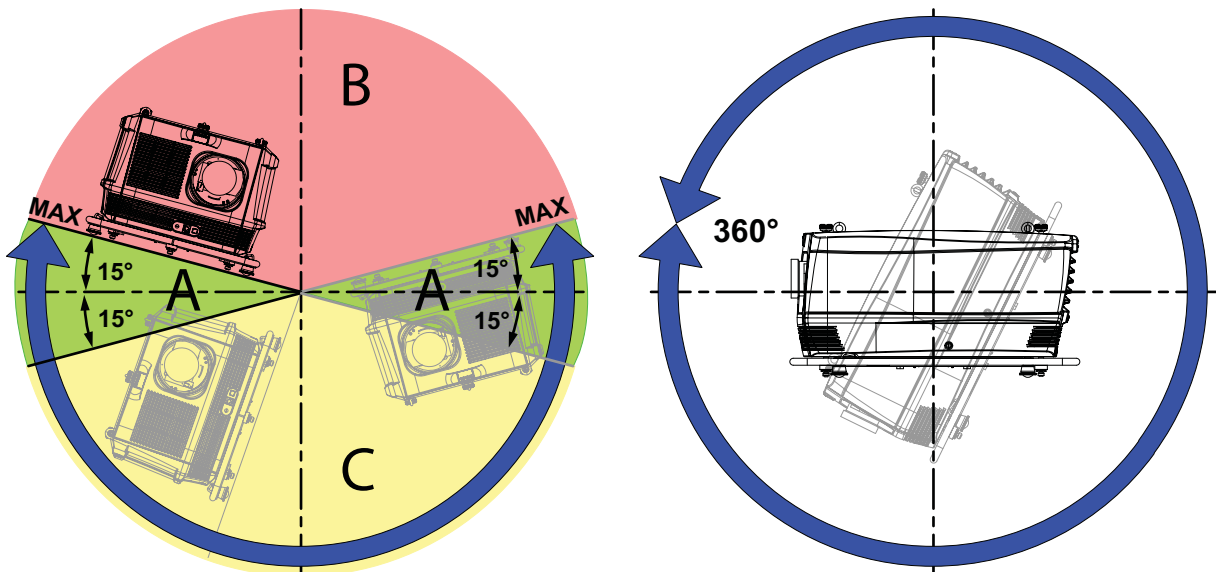


Image 2-10  
A Tilting allowed without problems  
B No tilting allowed in this area  
C Tilting allowed but lamp flicker possible



Projector lamp will not start up when out of tilt range due to build-in tilt sensor.

## 2.5 Projector air inlets and outlets

### Air inlets and outlets

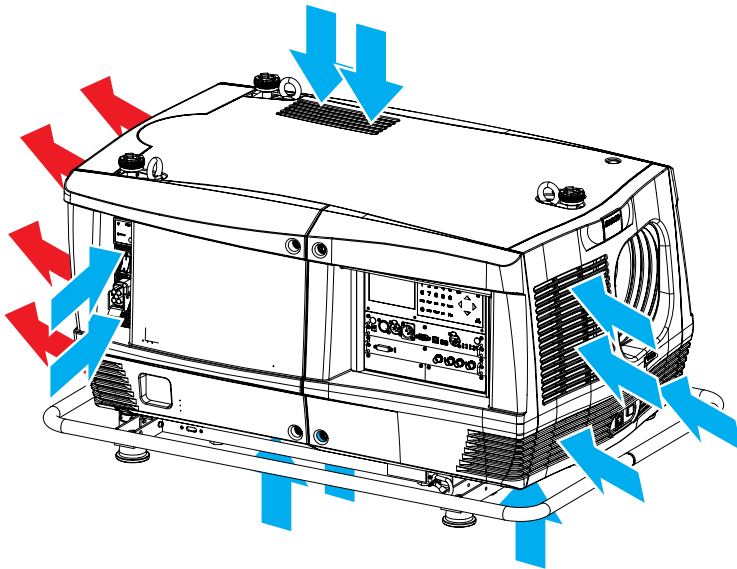


Image 2-11  
Airflow

The HDF series has 5 air inlet channels and one air outlet. The air outlet is located at the rear of the projector. The air inlets are located at the front, bottom, top and right side of the projector.

## 2.6 Free download of Projector Toolset

### About Projector Toolset

Projector Toolset is a software tool to set up, configure, manage and control Barco projectors.

The concept of this Projector Toolset software is modular. The basic package can be extended with several optional device plug-in modules, now and in the future available.

The Projector Toolset software works with configurations that can be loaded. Within a configuration, different snapshots can be taken. A snapshot represents a current state of a configuration and can be reloaded to return to this typical state. These terms will be used through the complete software.

Projector Toolset is a stand-alone application that runs on a Java Virtual Machine and that does not require extra services to run.

Several configurations can be controlled simultaneously. Even when the configurations are connected via different ways.



Projector Toolset is only available in a download version, no CD can be ordered.

### Where to find the download file(s)

The program and all necessary plug-ins, as well as the Reference manual can be downloaded for free from [my.barco.com](http://my.barco.com). Registration is necessary.

## 2. Configurations, requirements and restrictions

---

1. Go to my.barco.com on <https://my.barco.com>.
2. Login on my.barco.com.  
If you are not yet registered click on **Sign up for my.barco.com** and follow the instructions. With the created login and password, it is possible to enter the my.barco.com.  
When your login is correct, the my.barco.com start page is displayed.
3. Click the **Support** tab and follow the wizard to find your projector. The Projector Toolset is located under the tab Application Software.
4. Download the Projector Toolset software package, which includes the device plug-in updates as well as the corresponding reference manual.

When downloading the complete Projector Toolset, this software contains already the latest device plug-ins. When you already have the latest core version of Projector Toolset, it is possible to download only device plug-in updates from the same web site location.

As Projector Toolset is a stand alone application, it is not necessary to install any other software. A Java virtual machine is included with this download.

### Installation

Download first the reference manual (Part number: R59770052) and follow the installation instructions as written in this manual.

## 2.7 Installation process overview

---

### Quick setup

The following steps describe briefly how to setup your HDF series projector in a table mount front projection. Note that each step refers to a corresponding procedure, which is more detailed and illustrated.

1. Install the batteries of the remote control. See "RCU battery installation", page 21
2. Place the projector on a solid table in front of the screen at the expected throw distance. Ensure that the projector is installed at right angles (horizontally and vertically) with the screen. See "Projector configurations", page 16.
3. Select and install an appropriate lens, which covers the throw ratio ( = screen size / projector screen distance). See "Lenses", page 25.
4. Connect the projector with the local power net. See "Power connection", page 35.
5. Connect your source to the appropriate input module. See "Input source connections", page 42.
6. Switch ON the projector. See "Power on projector", page 51.
7. Select the input slot to which the source is connected. Do this by pressing the numeric key on the remote control unit or on the local keypad, See "Source selection", page 57.
8. Zoom and shift the lens until the image is properly projected on the screen, Do this by using the "ZOOM" and "FOCUS" key on the remote control unit or on the local keypad. If necessary, level the projector from side to side by turning the adjustable feet in or out.



**Check cooling liquid level at least every 6 months.**

**Every 6 months at device power up a message will be displayed on the local LCD to check the cooling liquid level**

---



## 3. PHYSICAL INSTALLATION

### About this projector

This chapter describes how the mechanical set up of the projector has to be done and how to realize the electrical connections.

### Overview

- Remote control unit (RCU)
- Lenses
- Power connection
- Suspension of the HDF series projector with rigging clamps

## 3.1 Remote control unit (RCU)

### Introduction

The remote control unit (A) of the HDF series projector is equipped with a rugged case (B) and an XLR adaptor (C). The remote control unit can be used wired via mini-jack or via rugged XLR. Note that the backlight, of the remote control unit, illuminate continuously when wire connected.

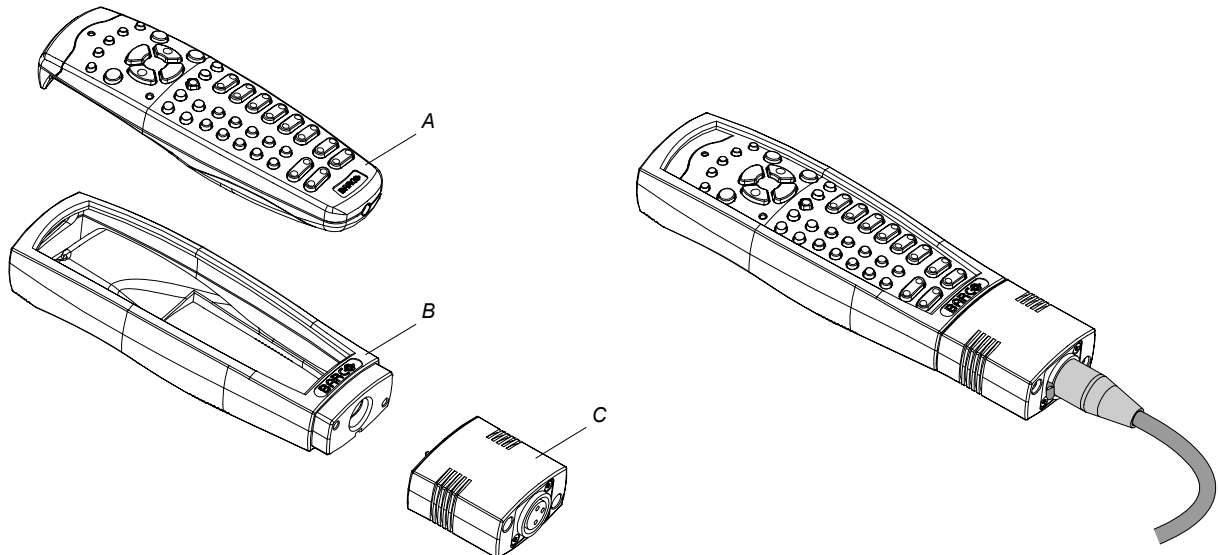


Image 3-1

- A Remote control unit (RCU).
- B Rugged case.
- C XLR adaptor.

### Overview

- RCU battery installation
- RCU rugged case installation
- RCU XLR adaptor installation
- Using the XLR adaptor of the RCU
- RCU usage possibilities

### 3.1.1 RCU battery installation

#### Where to find the batteries for the remote control ?

The batteries are not placed in the remote control unit to avoid control operation in its package, resulting in a shorter battery life time. At delivery the batteries can be found in a separated bag attached to the remote control unit. Before using your remote control, install the batteries first.

#### How to install the batteries in the remote control ?

1. Push the battery cover tab with the fingernail a little backwards (1) and pull, at the same time, the cover upwards (2).

### 3. Physical installation

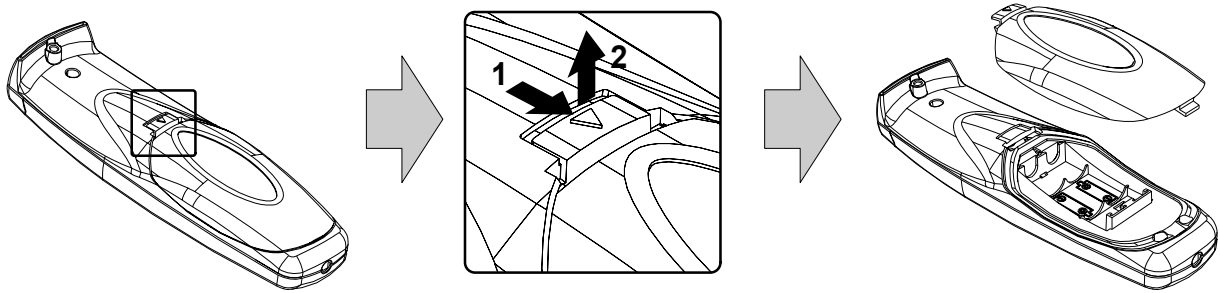


Image 3-2

2. Insert the two AA size batteries, making sure the polarities match the + and - marks inside the battery compartment.

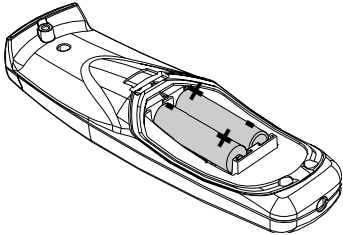


Image 3-3

3. Insert (1) the lower tab of the battery cover in the gap at the bottom of the remote control, and press (2) the cover until it clicks in place.

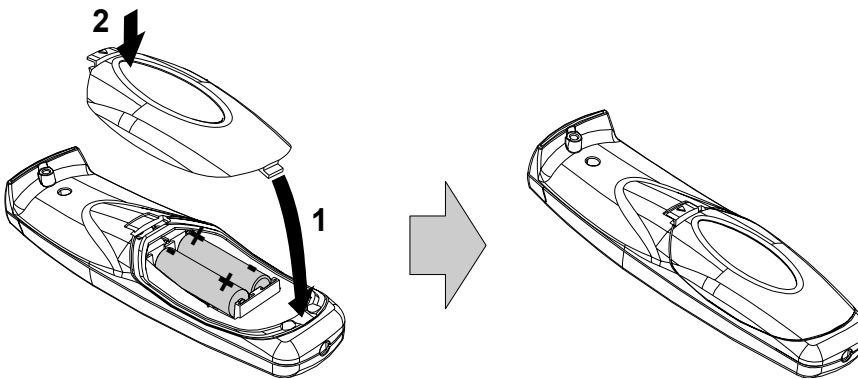


Image 3-4



**CAUTION:** Replace with the correct battery type. Use two AA size batteries. There is a risk of explosion if the battery is replaced with an incorrect type.



**CAUTION:** Replace the battery as explained above. There is a risk of explosion if the battery is incorrectly installed.

#### 3.1.2 RCU rugged case installation

##### How to install the rugged case of the remote control ?

1. Slide the bottom of the RCU into the rugged case and then pull the top of the rugged case over the top of the RCU as illustrated.

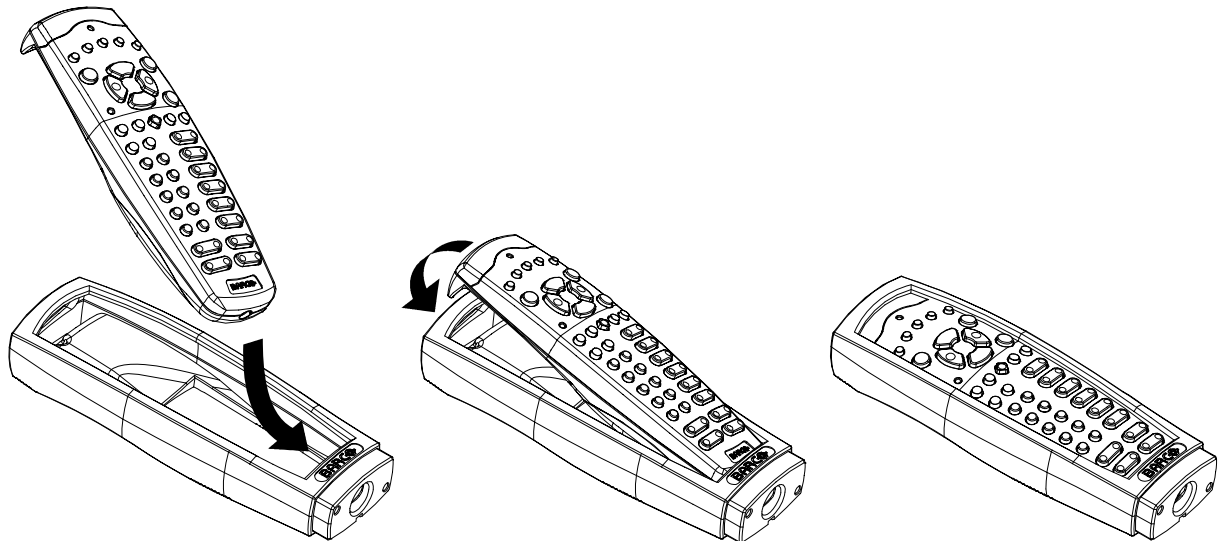


Image 3-5

### 3.1.3 RCU XLR adaptor installation



Install the rugged case before installing the XLR adaptor. Vice-versa, remove the XLR adaptor before removing the rugged case from the RCU.

#### Necessary tools

5 mm flat screw driver.

#### How to install the XLR adaptor of the remote control unit ?

1. Push the XLR adaptor (C) upon the rugged case of the remote control unit as illustrated.  
**Note:** Ensure that the text of the XLR adaptor is on top.

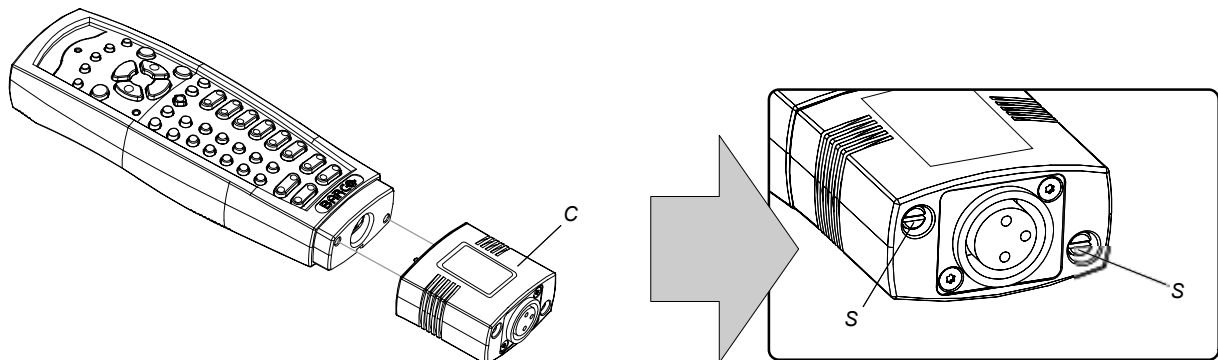


Image 3-6

2. Fasten the two screws (S) of the XLR adaptor. Turn each screw repeatedly one or two turns until both screws are tight.

### 3.1.4 Using the XLR adaptor of the RCU

#### How to use the XLR adaptor of the remote control unit ?

1. Connect a cable with XLR plug into the XLR adaptor.
2. Connect the other end of the cable with your HDF series projector.
3. Push the XLR adaptor completely against the rugged case of the remote control unit, as illustrated in the left image below, for wired communication. Pull out the XLR adaptor (about 8 mm) to switch over to wireless communication.

### 3. Physical installation

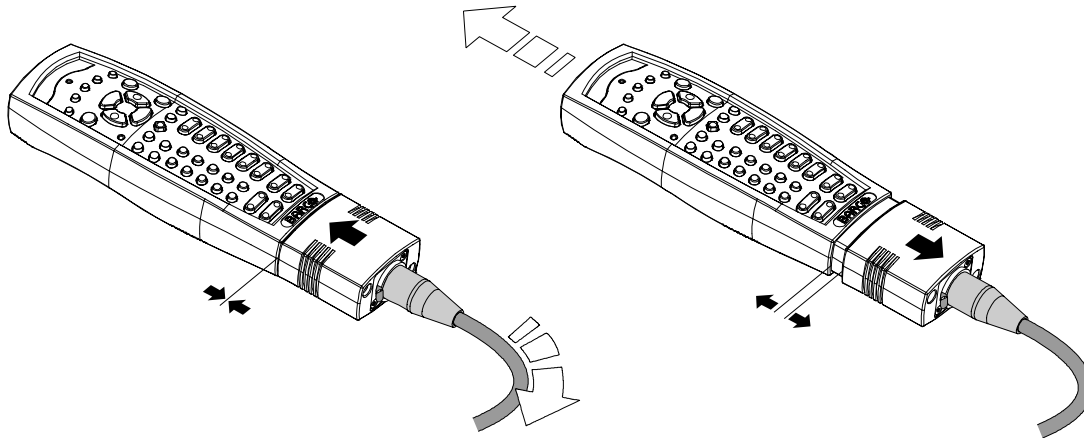


Image 3-7

#### 3.1.5 RCU usage possibilities

##### Summarized possibilities

Ref.	Possibility description	Comment
a.	RCU not wired	
b.	RCU wired (mini-jack)	Backlight illuminates continuously when wire is connected. Infra red disabled.
c.	RCU with rugged case not wired	
d.	RCU with rugged case wired (mini-jack)	Backlight illuminates continuously when wire is connected. Infra red disabled.
e.	RCU with rugged case and XLR adaptor pulled out "REMOTE" and not wired	The XLR adaptor must be in the pulled out position "REMOTE", otherwise the RCU will not function.
f.	RCU with rugged case and XLR adaptor pulled out "REMOTE" and wired	The RCU will send the commands via infra red to the projector.
g.	RCU with rugged case and XLR adaptor pushed in "WIRED" and wired	The RCU will send the commands via the cable connected with the XLR adaptor to the projector. Backlight illuminates continuously when wire is connected. Infra red disabled.

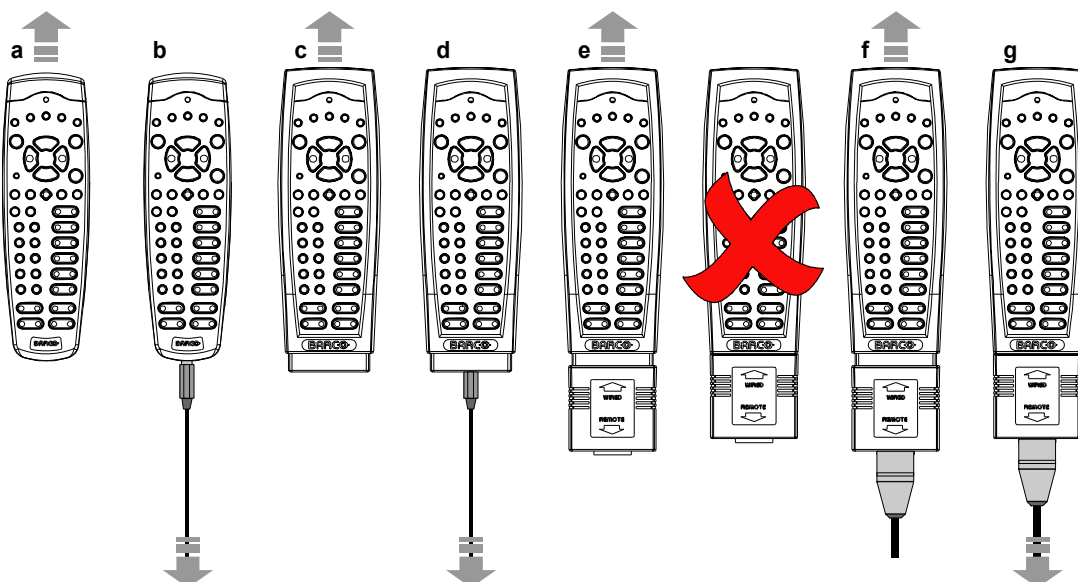


Image 3-8

## 3.2 Lenses

### Overview

- Available lenses
- Lens selection
- Lens installation
- Lens removal
- Lens safety cable
- Lens shift, zoom & focus
- Scheimpflug adjustment

### 3.2.1 Available lenses

#### Available lenses for the HDF series projector



Image 3-9  
R9840775: TLD+ (1.16 : 1) fixed lens



Image 3-10  
R9862000: TLD+ lens (0.67 : 1)



Image 3-11  
R9862005: TLD+ zoom lens (1.16 - 1.49 : 1)



Image 3-12  
R9862010: TLD+ zoom lens (1.39 - 1.87 : 1)



Image 3-13  
R9862020: TLD+ zoom lens (1.87 - 2.56 : 1)



Image 3-14  
R9862030: TLD+ zoom lens (2.56 - 4.16 : 1)



Image 3-15  
R9862040: TLD+ zoom lens (4.16 - 9.6 : 1)



Image 3-16  
R9829997: TLD+ zoom lens (9.6 - 10.39 : 1)

### 3. Physical installation

#### 3.2.2 Lens selection

##### How to select the right lens

1. Determine the required screen width (SW).
2. Determine the approximate position of the projector in the room.
3. Start up the *Lens Calculator* on the Barco website: <http://www.barco.com/en/tools/lenscalculator> to determine the possible lenses for your configuration.

The Lens Calculator window opens.

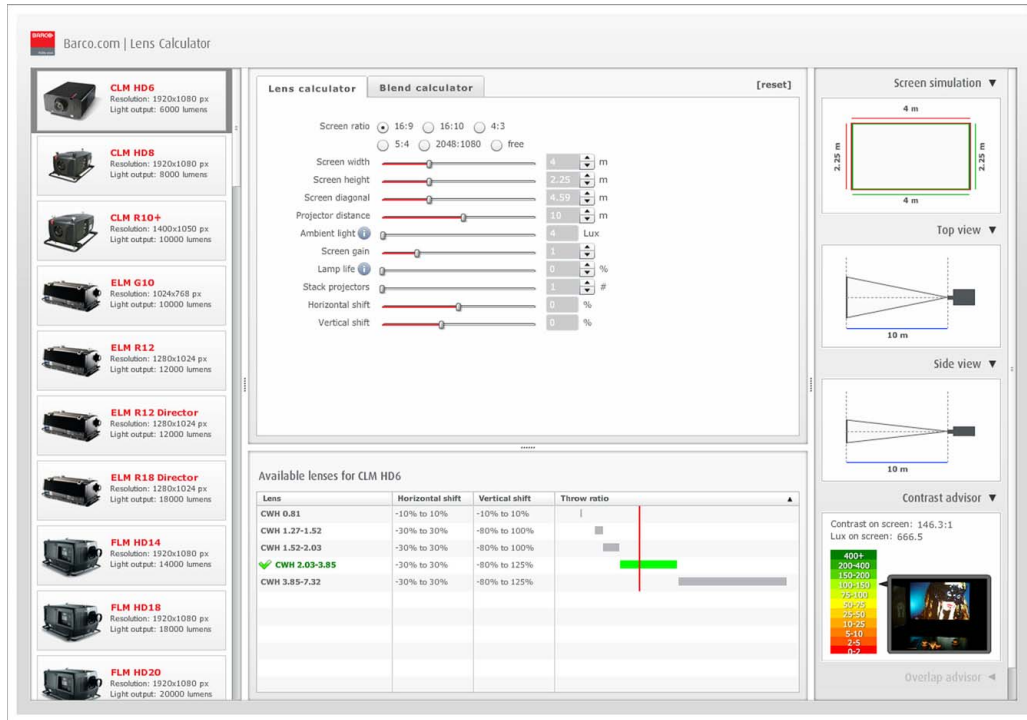


Image 3-17  
Lens calculator



The Lens Calculator can also be used to determine the position of the projector when the lens type and screen width is known.



Due to lens tolerances the results of calculated values may be different from measured values. These difference may vary +/- 5%.

#### 3.2.3 Lens installation

##### How to install

1. Remove the foam rubber in the opening of the lens holder if not removed yet.
2. Take the lens assembly out of its packing material and remove the lens caps on both sides.
3. Place the lens holder in the "unlocked" position by moving the lens lock handle (A) towards the lens power supply socket (B) as illustrated.

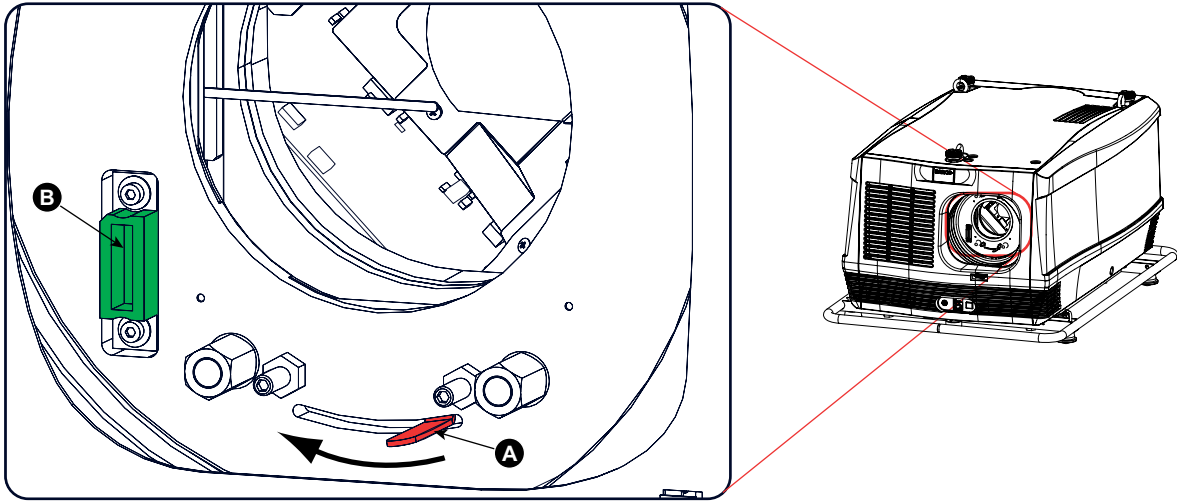


Image 3-18  
Lens installation, preparation

4. Ensure that the lens holder stands in the On-Axis position (horizontal and vertical mid position).  
**Note:** *The lens holder is placed default in the On-Axis position at factory.*
5. Gently insert the lens in such a way that the lens connector matches the socket (B).

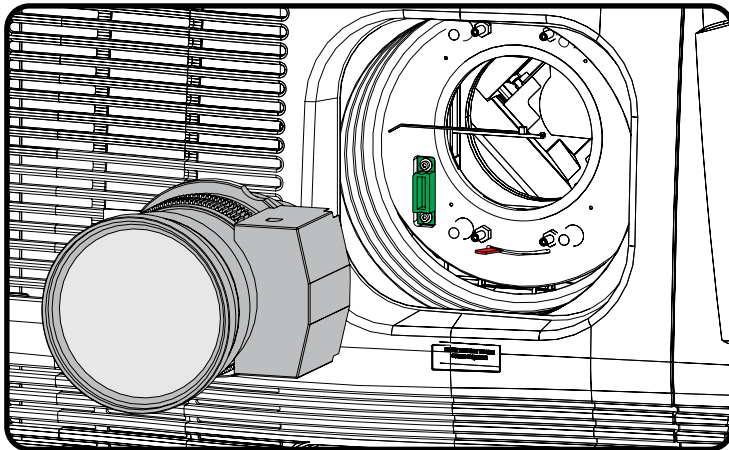


Image 3-19  
Lens insertion

6. Insert the lens until the connector seats into the socket.  
**Warning:** *Do not release the Lens yet, as the Lens may fall out of the Lens Holder.*
7. Secure the lens in the lens holder by sliding the lens lock handle into the "locked" position, which is away from the lens power supply socket. Ensure the lens touches the front plate of the lens holder.

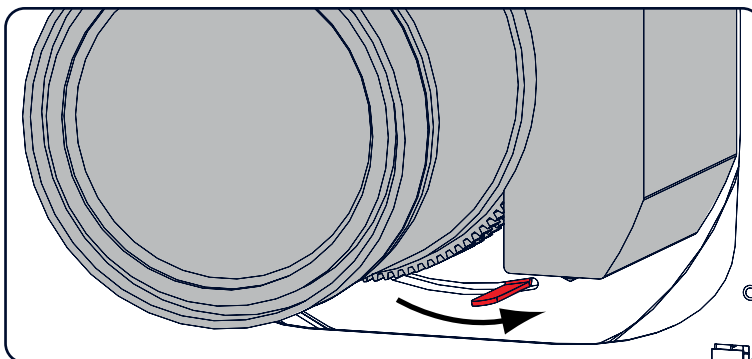


Image 3-20  
Lock lens

8. Check if the lens is really secured by trying to pull the lens out of the lens holder.

### 3. Physical installation

---

#### 3.2.4 Lens removal

##### How to remove

1. Support the lens with one hand while you unlock the lens holder by sliding the lock handle towards the “unlocked” position as illustrated.

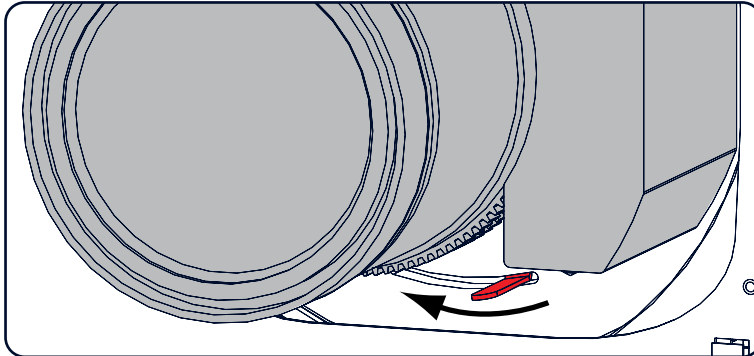


Image 3-21  
Lens removal, unlock

2. Gently pull the lens out of the lens holder.

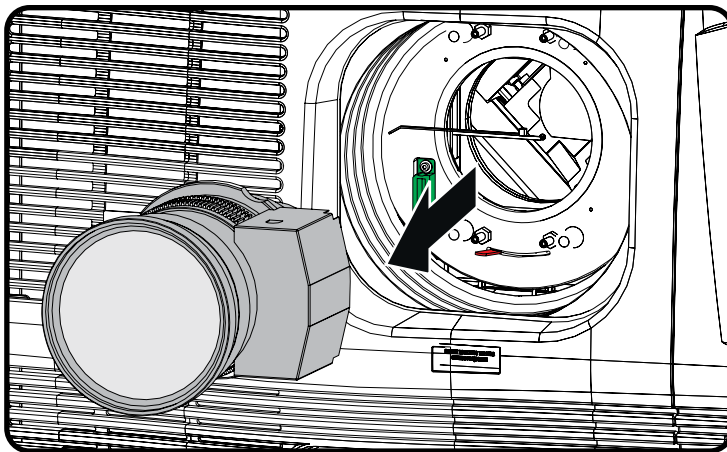


Image 3-22  
Lens removal



It's recommended to place the Lens caps of the original Lens packaging, back on both sides of the removed Lens to protect the optics of the Lens.



It's recommended to place the foam rubber of the original projector packaging, back into the Lens opening to prevent intrusion of dust. Note that this foam rubber is packed in a plastic bag to prevent the dust, emitted by the foam, from entering the projector.

#### 3.2.5 Lens safety cable

##### When using the safety cable ?

The lens safety cable must be used in any circumstances to protect a mounted lens in the lens holder.

##### How to mount the cable

1. Put the safety cable around the lens. Make sure the cable is mounted between the motor part and the mounting flange



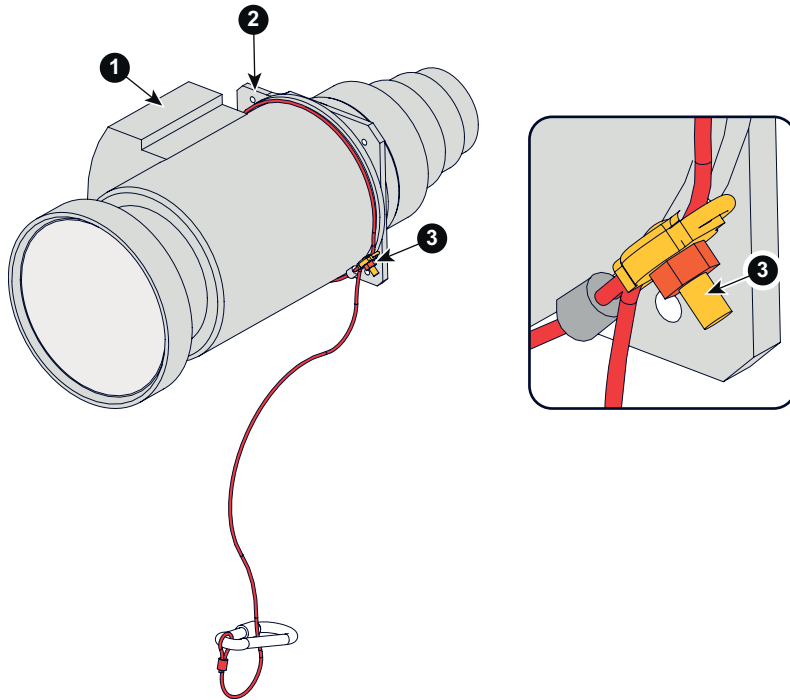


Image 3-23  
Lens safety cable

- 1 Lens motor block
- 2 Mounting flange
- 3 Clamp

2. Insert both cable sides into the clamp;  
Strap the cable and make sure that the clamp is positioned on 45° from the bottom to avoid interference of the cable with the lens locking mechanism.  
Secure the cable by fixating the nut of the clamp.

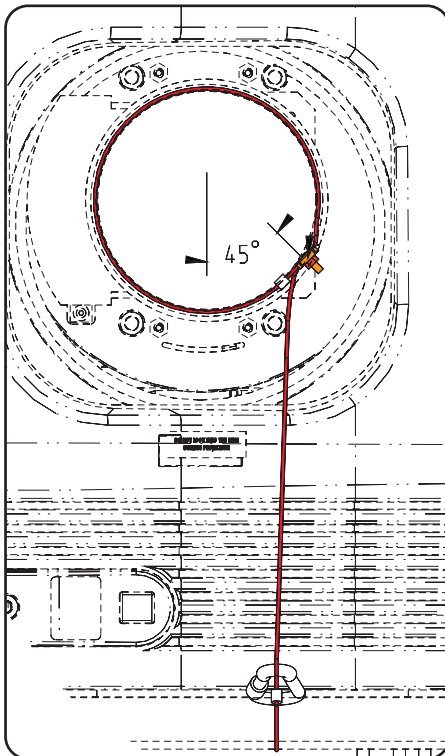


Image 3-24  
Clamp position

3. Turn the cable with hook lock around the carry handle and hook the hook lock around the cable.

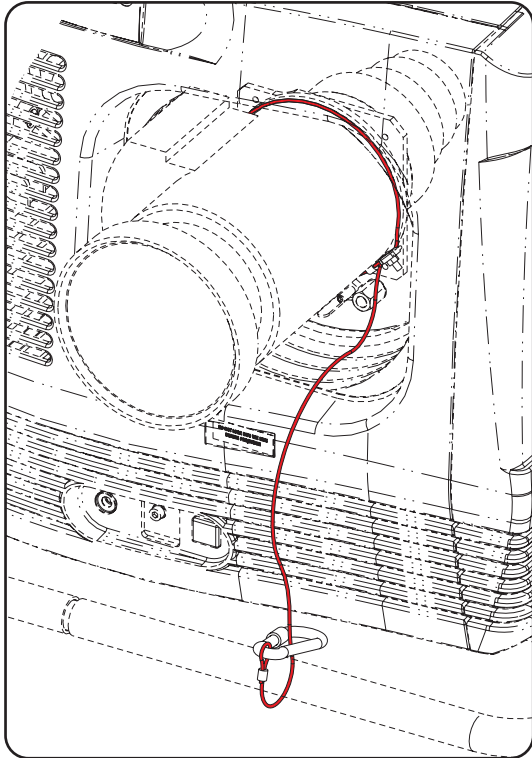


Image 3-25

### 3.2.6 Lens shift, zoom & focus

#### Via Lens key

1. Press **LENS** key on the local keypad or the remote control.  
The zoom/focus menu opens.

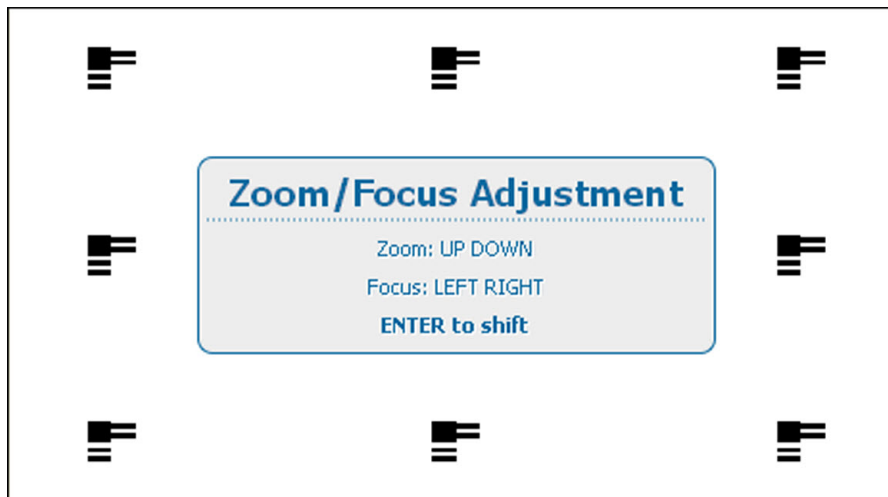


Image 3-26  
Zoom/Focus adjustment

2. Use the **▲** or **▼** key to zoom the lens.  
Use the **◀** or **▶** key to focus the lens.  
Press **ENTER** to switch to Lens shift adjustment.

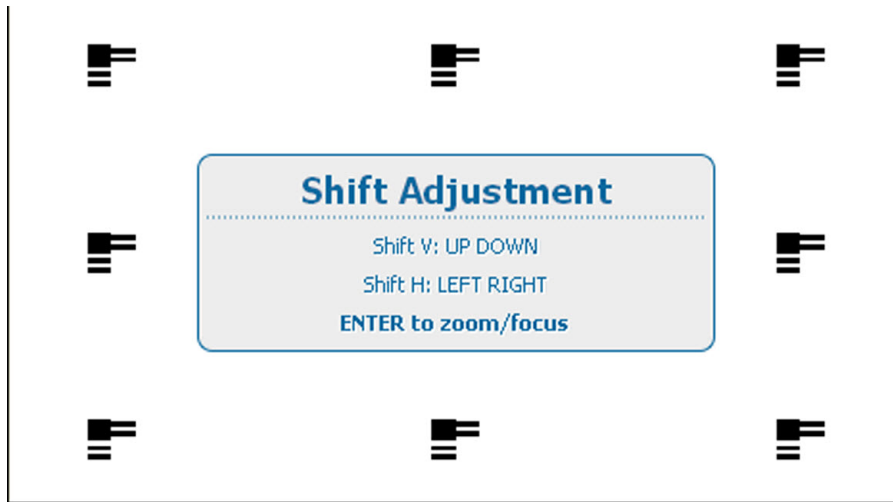


Image 3-27  
Shift adjustment

- Use the ▲ or ▼ key to shift the lens in vertical direction.  
Use the ◀ or ▶ key to shift the lens in horizontal direction.  
Press **ENTER** to switch to zoom/focus adjustment.

### Via direct access keys on the remote control

- Press **LENS FOCUS** button [-] or [+] (C) for an overall focus of the image.
- Press ▲ **LENS SHIFT** ▼ button for correct vertical position of the image on the screen.
- Press ◀ **LENS SHIFT** ▶ button for correct horizontal position of the image on the screen.



Take into account that the lens focus may slightly drift while the lens is warming up from cold to operation temperature. This is a typical phenomenon for projection lenses used with high brightness projectors. The operation temperature of the lens is reached after approximately 30 minutes projection of average video.

### 3.2.7 Scheimpflug adjustment

#### What has to be done ?

The lens holder has to be adjusted so that the "sharp focus plane" of the projected image falls together with the plane of the screen (Fp1→Fp2). This is achieved by changing the distance between the DMD plane and the lens plane (Lp1→Lp2). The closer the lens plane comes to the DMD plane the further the sharp focus plane will be. It can sometimes happen that you won't be able to get a complete focused image on the screen due to a tilt (or swing) of the lens plane with respect to the DMD plane. This is also known as Scheimpflug's law. To solve this the lens plane must be placed parallel with the DMD plane. This can be achieved by turning the lens holder to remove the tilt (or swing) between lens plane and DMD plane (Lp3→Lp4).

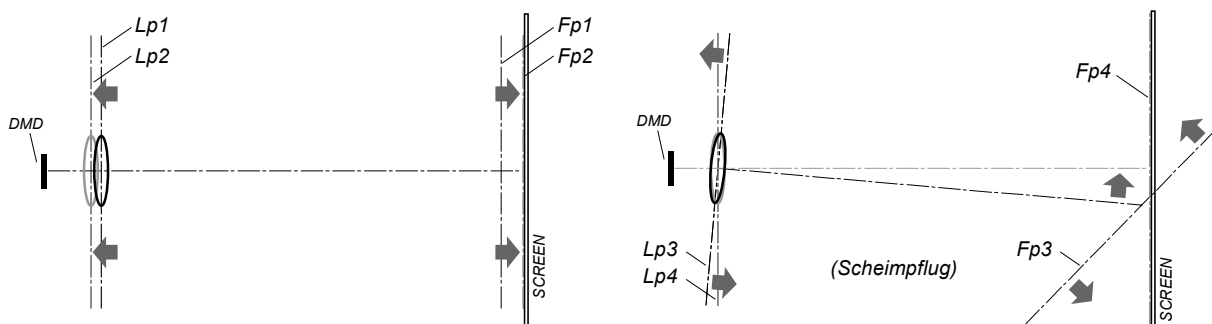


Image 3-28  
Scheimpflug principle



#### Scheimpflug principle

The "plane of sharp focus" can be changed so that any plane can be brought into sharp focus. When the DMD plane and lens plane are parallel, the plane of sharp focus will also be parallel to these two planes. If, however, the lens plane is tilted with respect to the DMD plane, the plane of sharp focus will also be tilted according to geometrical and optical properties. The DMD plane, the principal lens plane and the sharp focus plane will intersect in a line below the projector for downward lens tilt.

### Scheimpflug adjustment points

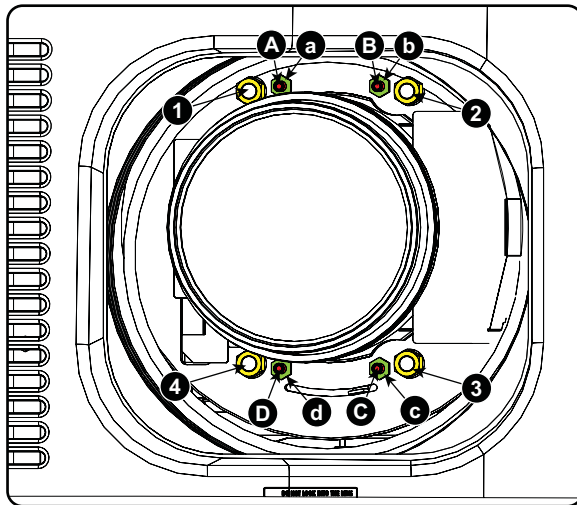


Image 3-29  
Scheimpflug adjustments

Indication on drawing	Function
4	Locking nut
1, 2 and 3	Scheimpflug adjustment nuts
A, B, C and D	Set screws
a, b, c and d	lock nuts

1, 2 and 3 are adjustment points.

4 is a locking point and NOT used during Scheimpflug adjustment.

#### Necessary tools

- Allen key 3 mm
- Nut driver 13 mm
- Nut driver 10 mm

#### How to adjust

1. Project a green focus pattern.

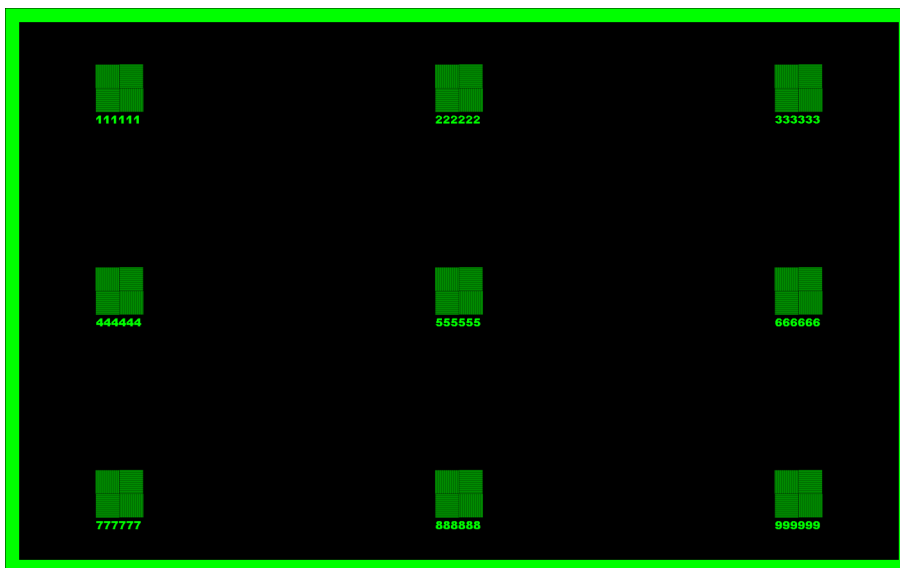


Image 3-30

2. Loosen the lock nuts (a, b, c and d). See image 3-29.
3. Loosen the 4 set screws (A, B, C and D) by 1 cm. See image 3-29.
4. Fully loosen lock nut 4. See image 3-29.

5. Optimize the focus of the projected image as follows:
  - a) Place the zoom lens in TELE position (smallest projected image) and adjust the focus using the lens focus barrel or motorized focus control.
  - b) Place the zoom lens in WIDE position (largest projected image) and adjust the focus by turning equally on nut 1, 2 and 3.
  - c) Repeat steps "a" and "b" until the projected image is as sharp as possible.

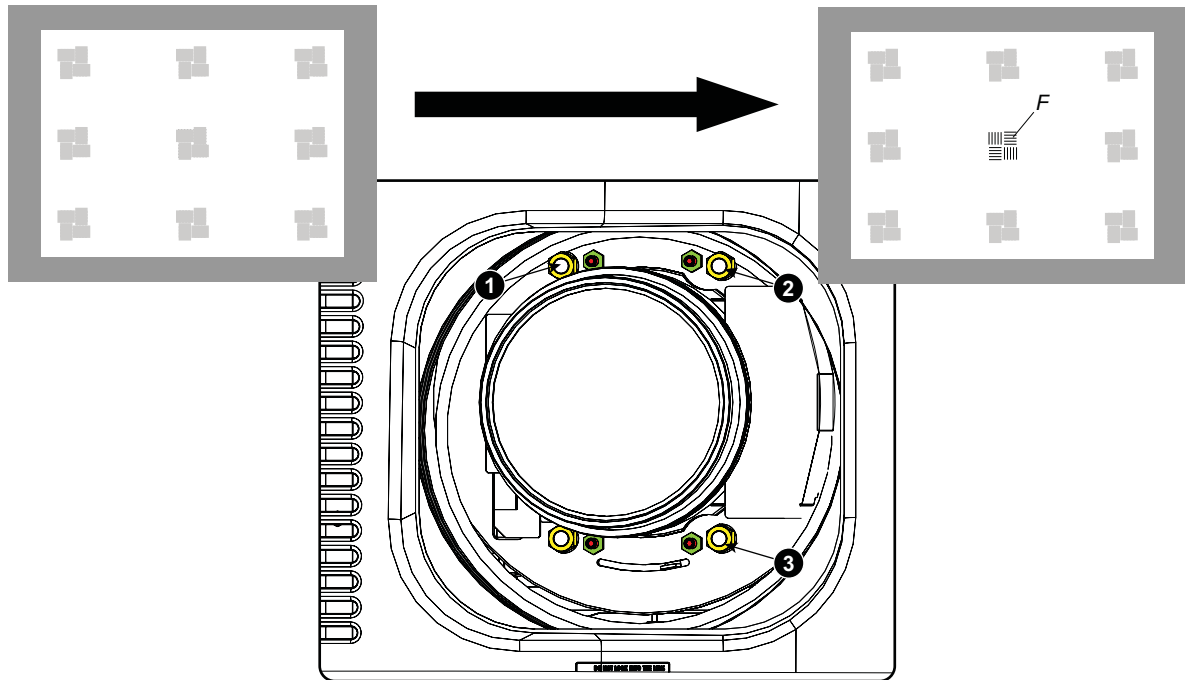


Image 3-31  
Center focusing

6. Sharpen bottom left corner of the screen by adjusting nut 1.

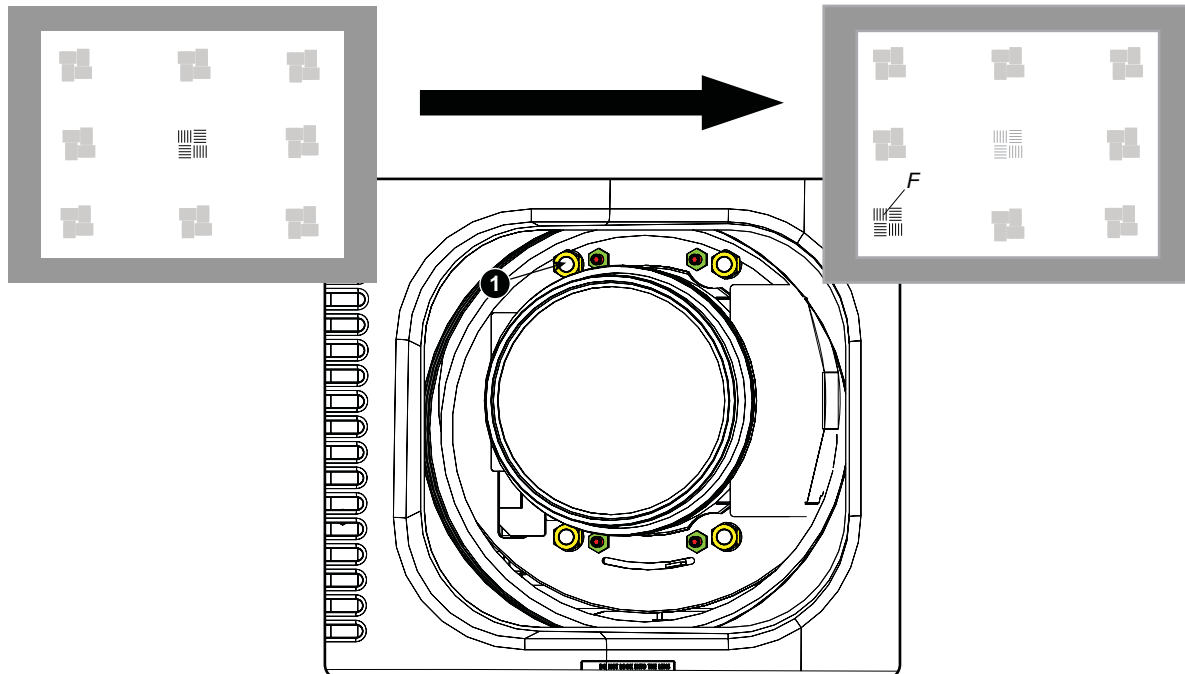


Image 3-32  
Left bottom focusing

7. Sharpen bottom right corner of the screen by adjusting nut 2.

### 3. Physical installation

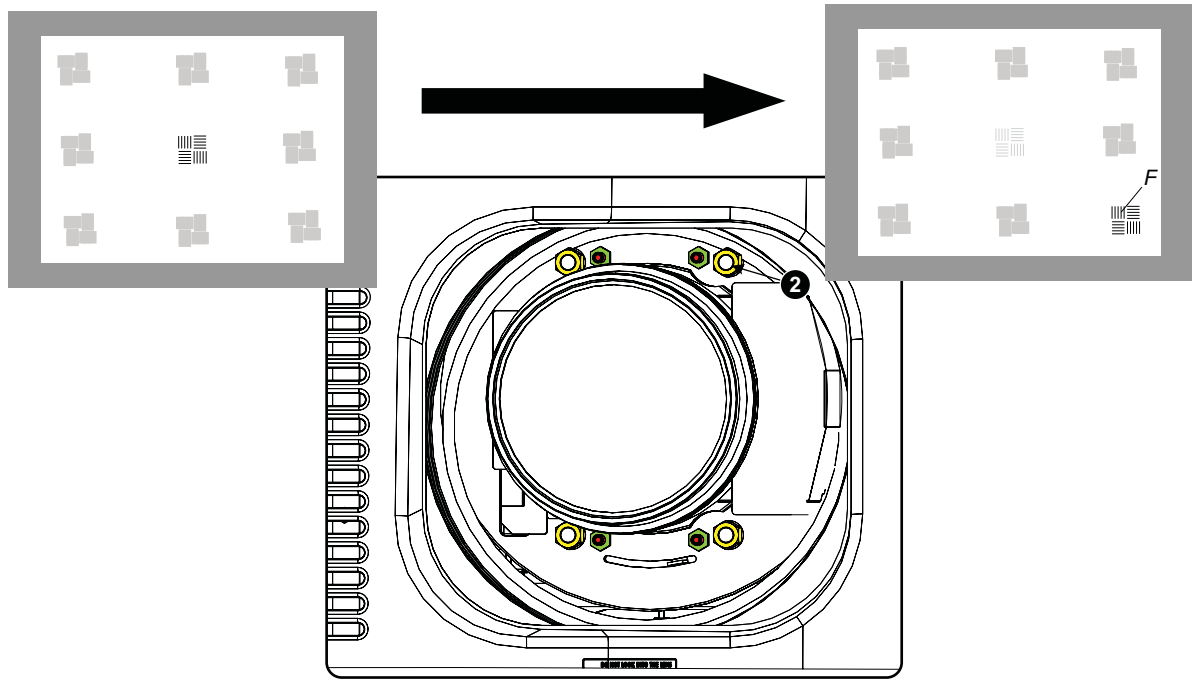


Image 3-33  
Right bottom focusing

8. Sharpen top right corner of the screen by adjusting nut 3

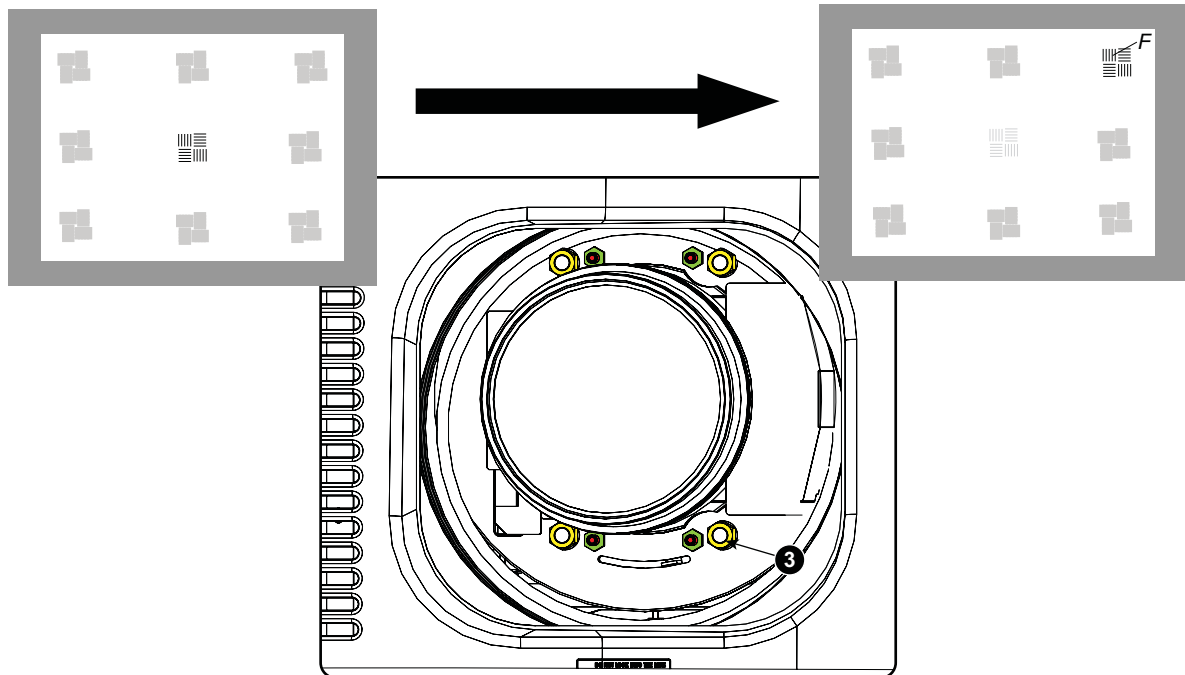


Image 3-34  
Corner focusing

9. Repeat from step 6 until the projected focus pattern is as sharp as possible in the center, left, right, top and bottom of the screen.

#### How to fix the Scheimpflug

Start the fixation as follows (steps must be followed strictly) :

1. Turn in set screw A, B and C. Tighten lightly (by hand).  
**Tip:** Any movement of the image will affect the Scheimpflug adjustment
2. Fasten lock nuts a, b and c.
3. Turn in set screw D lightly (by hand) allowing the image to move slightly (1/3 to 1/2 of a square).

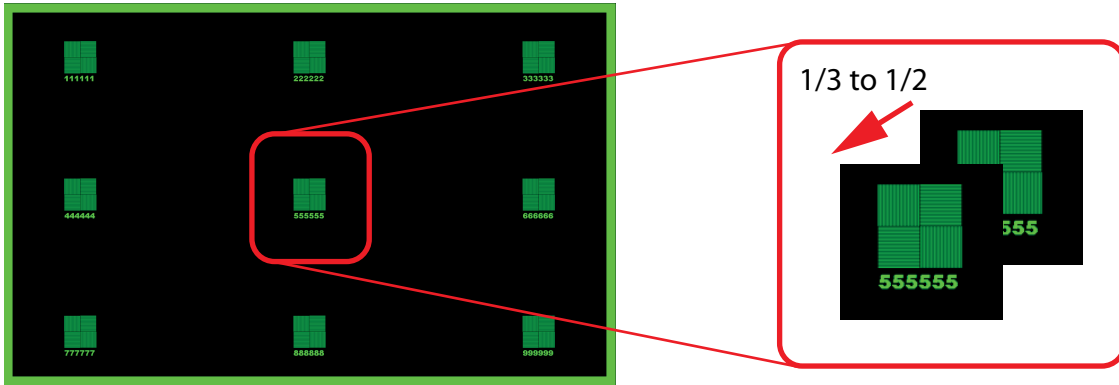


Image 3-35

4. Fasten lock nut d.
5. Tighten nut 4 until the offset of the image movement created in step 3 is canceled.  
**Tip:** *The amount of image movement in step 3 will determine how tight the nut in step 5 will need to be turned to return the image to its original position.*

### 3.3 Power connection

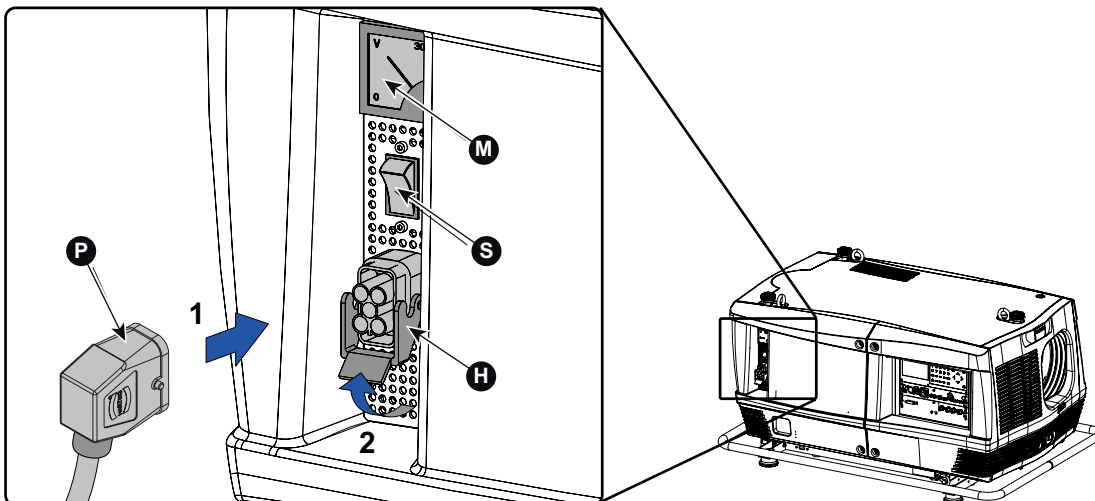


**CAUTION:** Use only the power cord provided with the projector.

#### How to connect your projector with the local power net ?

1. Ensure that the power switch (S) stands in the "0" (OFF) position.
2. Connect the power cord (P) with the power input socket of the projector as illustrated below.
3. Secure the power plug by locking the plug holder clamp (H).
4. Connect the other end of the power cord with the local power net.  
**Caution:** *Ensure that the power net meets the power requirements of the projector.*

The voltmeter (M) will immediately indicate the value of the mains voltage as soon as the projector is connected with the power net.

Image 3-36  
Power connection

#### Fuses

The projector is protected with an automatic circuit breaker of 35 A which is built in into the power switch.

### 3. Physical installation

#### Volt meter

After starting up the projector (lamp ignition) check if the value indicated by the volt meter is still within the specified power range of the projector. Note that in case the power net drops significantly during start up, the lamp will fail the ignite. If this is the case, take the necessary measures to reinforce the power net to the projector before starting up the projector again.

Volt meter is protected with a Miniature Fuse, 5 x 20 mm, T 1AH, 250 VAC, UL: 115 V - 300 VDC.

#### Spare power plug

The projector is delivered with a spare power plug. This spare power plug is attached behind the nameplate of the projector. Remove the cover of the lamp first to access this spare power plug. Note that only qualified technical personnel may install a new power plug.

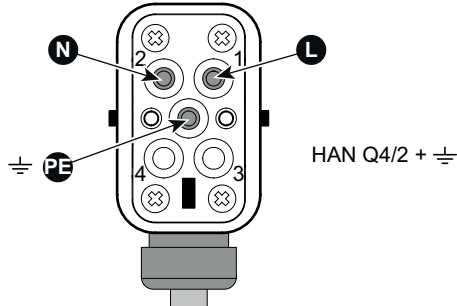


Image 3-37  
Pin configuration power plug HAN Q4/2 + PE.

### 3.4 Suspension of the HDF series projector with rigging clamps

#### Rigging points and rigging clamps

The carrying handle, at the bottom side of the projector, is provided with eight slots. Four slots are longitudinally (A) oriented and four slots are transversely (B) oriented. Each slot contains a rigging point of which the position in the slot can be adjusted depending on the size of the truss installation. The rigging clamps (C) can be attached to those rigging points, which allows an easy and fast physical setup of the projector in a hanging configuration.

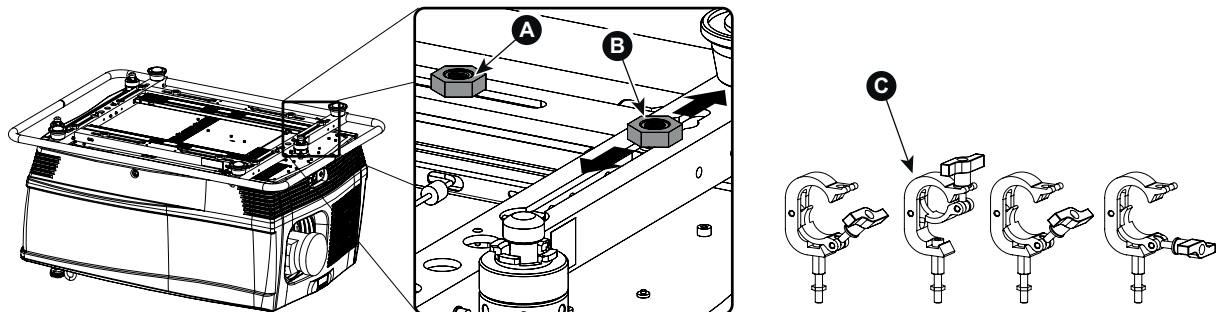


Image 3-38  
Rigging points

#### Necessary tools

- 24 mm open ended spanner.
- 17 mm open ended spanner.

#### Necessary parts

- Four rigging clamps (R820411).
- Safety chains.

#### How to install and to use the rigging clamps ?

1. Measure the distance, center tube as reference, between the two used support bars of the truss.



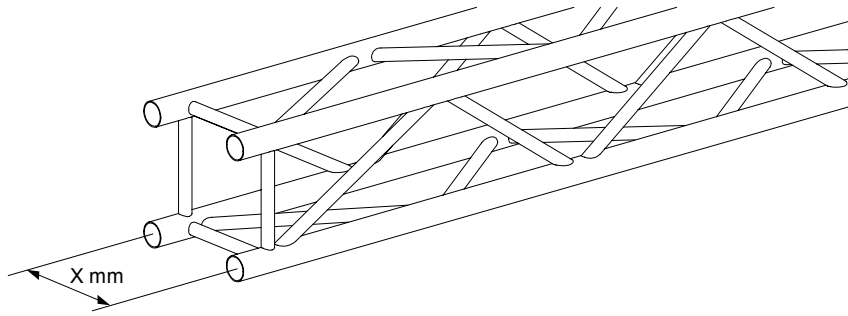


Image 3-39

- Turn the projector upside down and slide the rigging points on there place in the slots, according the measured distance and secure this position. To release the nuts of the rigging points use a 24 mm open ended spanner. Ensure that the rigging points are symmetrically lined up, so that the projector will hang in balance.

**Warning:** Be careful while working with heavy loads.

**Warning:** Always secure the rigging points after adjustment.

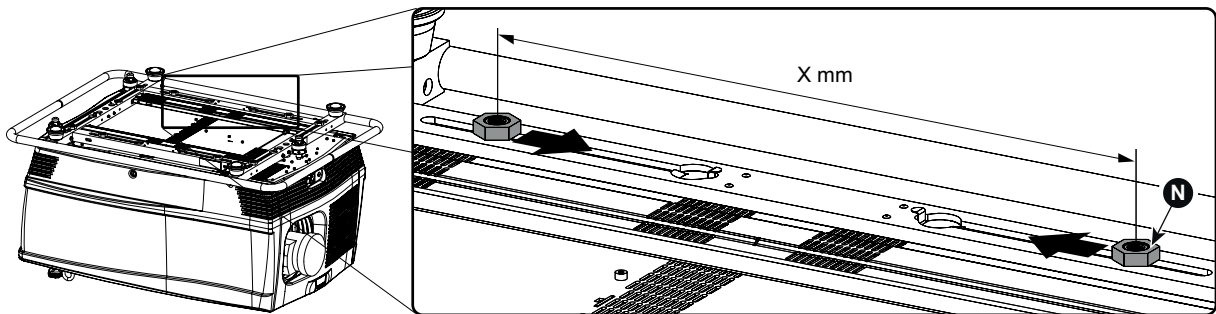


Image 3-40  
Rigging points, distance

- Turn in the rigging clamps (A) into the rigging points using a 17 mm open ended spanner and secure the rigging clamps by turning the safety nut (B) on the rigging clamp against the rigging point using a 17 mm open ended spanner.

**Warning:** Always use four (4) rigging points, equally spread, to suspend the projector.

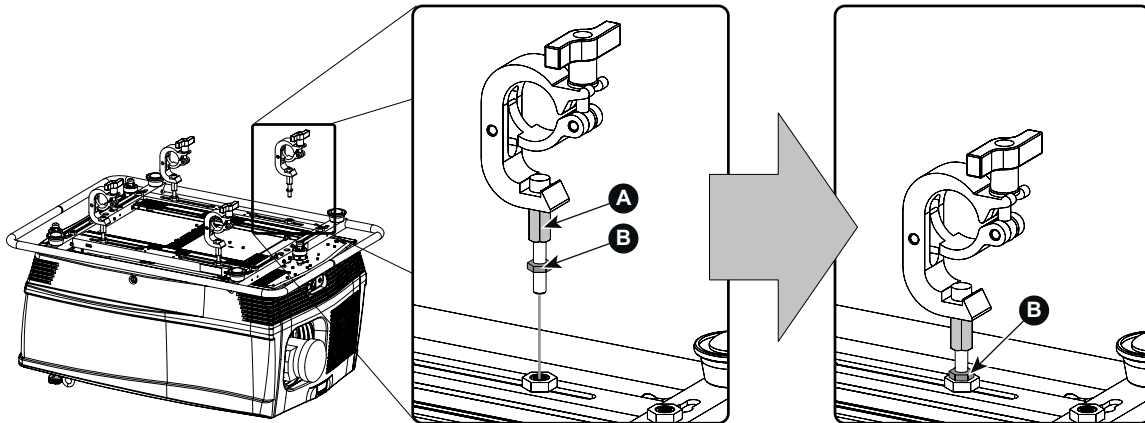


Image 3-41  
Mounting clamps

- Place all four rigging clamps in open position as illustrated.

### 3. Physical installation

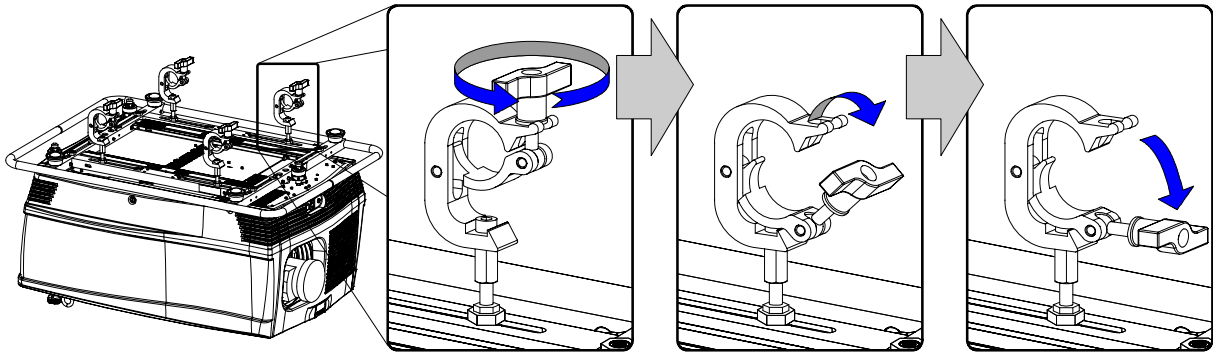


Image 3-42  
Opening clamps

5. Place the projector (upside down) under the truss installation and lower the truss until the support bars of the truss are nearly by the rigging clamps mounted on the projector.

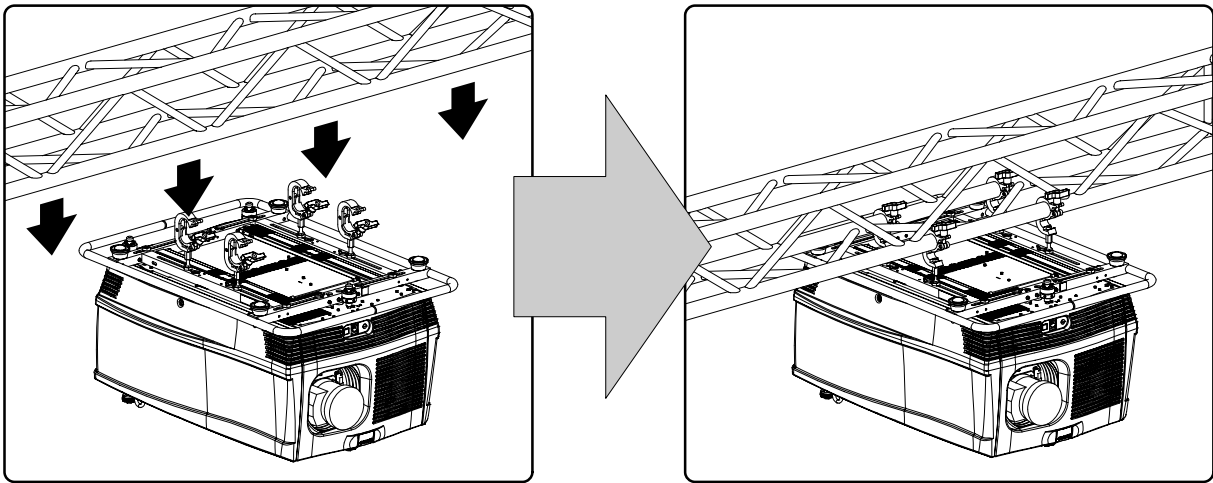


Image 3-43  
Lowering and mounting truss bar

6. Lift up the projector and hook the four rigging clamps over the support bars of the truss.
7. Lock all four rigging clamps.
8. Install a safety chain (S) around both sides of the carrying handle and around the truss.

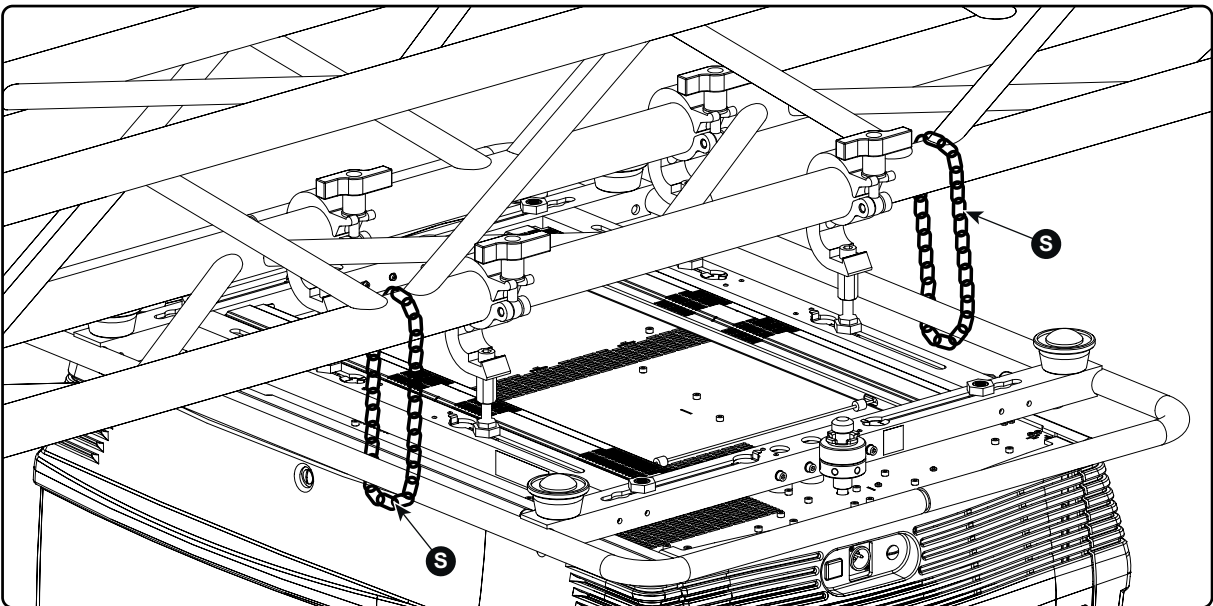


Image 3-44  
Mounting Safety chains

**Warning:** Install the safety chain in that way that the projector cannot drop more than 20 cm.

9. Lift up the truss with attached projector to the desired height.



Proceed with the alignment procedure, see "Alignment of a ceiling mount HDF series projector", page 58.

---



## 4. INPUT & COMMUNICATION

### Overview

- Introduction
- Input source connections
- Communication connections

### 4.1 Introduction

#### General

The Input & Communication side of the projector consists of a button module, a dual 3G/HDSI and DVI-I input as standard input module and 2 free input slots. The free input slots can be used for optional modules (e.g. 5-cable input).

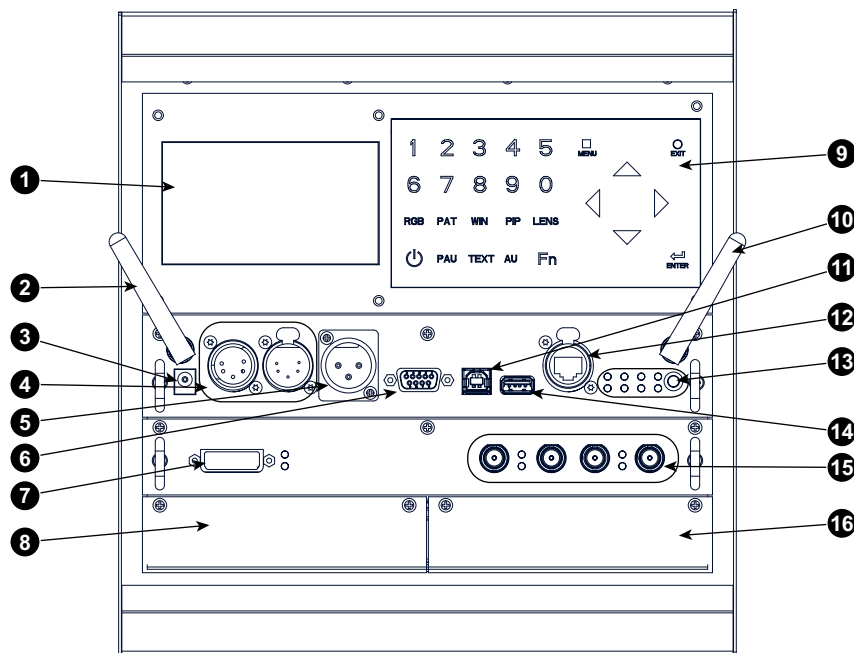


Image 4-1  
Input & Communication connections

- 1 Display
- 2 Optional antenna for Wifi connection
- 3 12 V output as power supply to external equipment
- 4 DMX in - out
- 5 XLR input port for remote control
- 6 RS232/RS422 input port
- 7 Dual Link DVI-I HDCP input
- 8 Free input slot
- 9 Button module
- 10 Optional antenna for GSM
- 11 RS232/RS422 input port
- 12 Ethernet port
- 13 Status and indication LEDs
- 14 USB port
- 15 3G/Dual/HDSI input - output
- 16 Free input slot

## 4.2 Input source connections

### DVI and 3G/HDSDI input

This input module is standard delivered with the HDF series projector.



Image 4-2  
Dual Link DVI and 3G/Dual HDSDI input

The yellow LED lights up when valid input sync is detected.

The green LED lights up when the input is selected.

#### DVI input specifications :

- RGB analog : up to 170 MHz.
- Single DVI : up to 165 MHz
- Dual link DVI : up to 210 MHz



**DVI will not natively support 10-bit or 12-bit deep color. It is possible to enable 30-bit color over DVI using a specific pixel packing. We support the pixel-packing that is implemented by Silicon Image Sil7189 DVI receiver.**

#### 3G/Dual HDSDI input specifications :

- 3G follows the SMPTE 425M standard.
- HDSDI follows the SMPTE 292M standard.
- Dual link follows the SMPTE 372M standard
- SDI follows the 259M standard

### 5-cable input (optional)

Optional multi purpose input which can be inserted in the free slots.

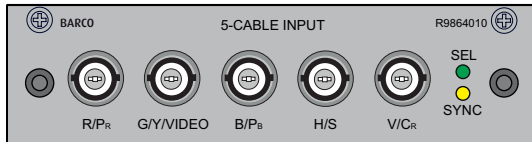


Image 4-3

#### Signal connectivity

Input signal	R / P <sub>R</sub>	G / Y / VIDEO	B / P <sub>B</sub>	H / S	V / C <sub>R</sub>
RGBHV	R	G	B	H	V
RGBS	R	G	B	S	—
RGsB	R	Gs	B	—	—
		sync on green			
RGBCV	R	G	B	CV	-
Composite Video	—	VIDEO	—	—	—
Super Video	—	Y	—	—	C
		Luma			Chroma
Component Video - S	P <sub>R</sub> / (R - Y)	Y	P <sub>B</sub> / (B - Y)	S	—
Component Video - SOY	P <sub>R</sub> / (R - Y)	Ys	P <sub>B</sub> / (B - Y)	—	—
YUV-CV	R-Y	Y	B-Y	CV	-

#### 5-cable input specifications :

- Data and HD sources RGB and YUV [HS/VS, CS or SOG(Y)]:
  - Pixel clock maximum 210 MHz
  - 8 bit digital output
- Video sources CVBS, S-VIDEO, RGB and YUV [CS, CV or SOG(Y)]:
  - PAL B/D/I/G/H, PAL60, PAL M, PAL N, PAL Nc
  - NTSC M/J, NTSC 4.43
  - SECAM B/D/G/K/L
  - 525i, 625i, 525p, 625p
  - Macrovision copy protection robust
  - Standard images "video525" and "video625"
- Automatic detection of sync inputs but with manual override:
  - automatic modes : RGB, YUV, VIDEO
  - manual modes : RGB HS/VS - CS, RGB CV, RGB SOG, YUV HS/VS - CS, YUV CV, YUV SOY, CVBS, S-VIDEO
- Possible to disconnect 75 Ohm terminations on HS and VS (TTL sync level selection)
- Signal requirements:
  - Component Video (BNC)
    - o R-Y : 0,7Vpp  $\pm$ 3dB 75 Ohm termination.
    - o Ys : 1Vpp  $\pm$ 3dB (0,7V Luma +0,3V Sync) 75 Ohm termination.
    - o B-Y : 0,7Vpp  $\pm$ 3dB 75 Ohm termination.
  - RG(s)B
    - o R : 0,7Vpp  $\pm$ 3dB 75 Ohm termination.
    - o G(s) : 1Vpp  $\pm$ 3dB (0,7Vpp G + 0,3Vpp Sync) 75 Ohm termination.
    - o B : 0,7Vpp  $\pm$ 3dB 75 Ohm termination.
- Diagnostic LED's on front panel:
  - Green LED: Lights up in case input module is selected
  - Yellow LED: Lights up in case sync detected

### 3D Input Module (optional)

Optional 3D input which can be inserted in the free slots.

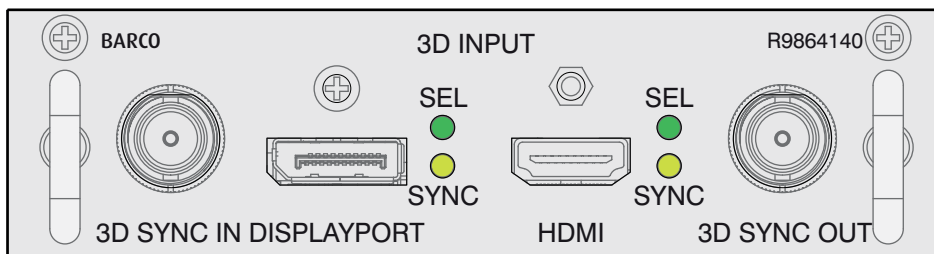


Image 4-4

#### Signal connectivity

- **3D SYNC IN**  
BNC socket to apply an external 3D synchronization signal. Used for sequential modes. If signal is not present an internal 3D sync is generated.
- **DISPLAYPORT**  
DisplayPort connector to connect a video source.
- **DisplayPort selection LED + sync LED**  
SEL: lights up if the DisplayPort is selected.  
SYNC: lights up if the applied source has a valid DisplayPort sync.
- **HDMI**  
Connector for HDMI cable (with optional locking mechanism).
- **HDMI selection LED + sync LED**  
SEL: lights up if the HDMI input port is selected.  
SYNC: lights up if the applied source has a valid HDMI sync.
- **3D SYNC OUT**  
BNC socket. Generates 3D synchronization signal to drive an infra red transmitter for active 3D glasses. In case an 3D synchronization signal is applied on the "3D SYNC IN" for a single channel 3D stream then the generated 3D output sync is derived from this applied sync.

#### Input specifications

## 4. Input & Communication

- **HDMI** (High-Definition Multimedia Interface)  
HDMI 1.4a up to 210MHz pixel clock. Support for 'Deep Color' up to 12 bit per color.
- **DisplayPort**  
DisplayPort 1.1a up to 210 MHz pixel clock. Support for 'Deep Color' up to 12 bit per color.



In all cases, the minimum input frequency for 3D is 23 Hz per eye. Below this frequency the image will not be displayed correctly.

## 4.3 Communication connections

### Communication interface

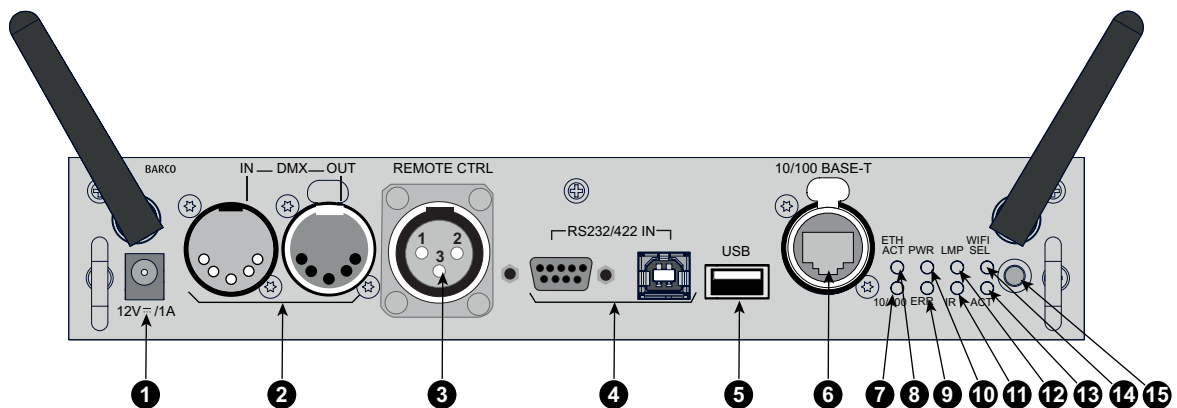


Image 4-5  
Communication interface, indications

- 1 12V 1A output
- 2 DMX interface (input, output)
- 3 XLR input
- 4 RS232 input
- 5 USB port
- 6 Ethernet port
- 7 Ethernet type indication
- 8 Ethernet activity indication
- 9 Error indication
- 10 Power indication
- 11 IR indication
- 12 Lamp indication
- 13 ACT (activity) indication
- 14 Wifi select indication
- 15 IR receiver

### 12V output

12 V output, maximum 1A, available when projector is not in stand by.

### DMX interface

DMX is used as communication bus between different devices in the light technic. Each device has an input and an output, so that the bus can be looped between the different devices. According the standard a five wire cable with XLR connector is used.

You can use the DMX input port to connect a DMX device (DMX console) to the projector. This way you can control the projector from that DMX device (console). The DMX output port can be connected with the next device in the loop.

Pin	Description
1	Earth



Pin	Description
2	Cold
3	Hot
4	Return - (or not used)
5	Return + (or not used)

**DMX**

DMX-512 Lighting protocol over RS-485 interface. Carries information of 512 channels from a lighting controller to lighting devices. Standardized by USITT.

**Wired remote control (XLR)**

If desired the remote control unit can be wired and plugged in into the male XLR port on the communication interface.

XLR – Remote CTRL in	
Pin	Description
1	GND
2	RC5 in
3	XLR present sense

**RS232/RS422 input**

The communication interface of the HDF series projector supports RS232 and RS422 serial communication on two different types of input connectors. The left one a Sub-D connector, the right one an USBB connector acting as RS input when connected to an USB input of a PC.

You can use the RS232/RS422 input to connect a local PC to your HDF series projector. By this way you can configure and control your HDF series projector from your local PC.



**Do not forget to set the projector's baud rate to match that of the computer.**

Advantages of using RS232/RS422 serial communication:

- easy adjustment of the projector via PC (or MAC).
- allow storage of multiple projector configurations and set ups.
- wide range of control possibilities.
- address range from 0 to 255.
- sending data to the projector (update).
- copying data from the projector (backup).

RS232/422 input (Sub-D) port	
Pin	Description
1	DCD : Data Carrier Detect
2	RXD- : Receive Data
3	TXD- : Transmitted Data
4	DTR : Data Terminal Ready [RS232] TXD+ : Transmitted Data [RS422]
5	GND : Ground
6	DSR : Data Set Ready [RS232] RXD+ : Received Data [RS422]
7	— (not connected) —
8	CTS : Clear To Send
9	RI : Ring Indicator



**RS232**

An Electronic Industries Association (EIA) serial digital interface standard specifying the characteristics of the communication path between two devices using either D-SUB 9 pins or D-SUB 25 pins connectors. This standard is used for relatively short-range communications and does not specify balanced control lines. RS-232 is a serial control standard with a set number of conductors, data rate, word length and type of connector to be used. The standard specifies component connection standards with regard to computer interface. It is also called RS-232-C, which is the third version of the RS-232 standard, and is functionally identical to the CCITT V.24 standard. Logical '0' is > + 3V, Logical '1' is < - 3V. The range between -3V and +3V is the transition zone.



**RS422**

An EIA serial digital interface standard that specifies the electrical characteristics of balanced (differential) voltage, digital interface circuits. This standard is usable over longer distances than RS-232. This signal governs the asynchronous transmission of computer data at speeds of up to 920,000 bits per second. It is also used as the serial port standard for Macintosh computers. When the difference between the 2 lines is < - 0.2V that equals with a logical '0'. When the difference is > +0.2V that equals to a logical '1'.

**USB port**

The communication interface is equipped with a master USB port, type "A" connector. This USB port will simplify the service procedures for software updates or for taking backup files from the projector without network connection. An USB-stick is plugged into the USB port and files can be transferred from or to the projector using the local or remote control unit. Note that the USB-stick has to be Linux FAT16 compatible.

**Ethernet port**

The projector can be connected to a LAN (local area network) using the Ethernet port on the communication interface. Once connected to the LAN, users are capable of accessing the projector from any location, inside or outside (if allowed) their company network using the control software: Projector Toolset. This toolset locates the projector on the network in case there is a DHCP server or the user can insert the correct IP-address of the projector to access the projector. Once accessed, it is possible to check and manipulate all the projector settings. Remote diagnostics, control and monitoring of the projector can then become a daily and very simple operation. The network connectivity permits to detect potential errors and consequently improve the time to servicing.



**The connector used for the Ethernet ports (E) are of rugged Neutrik EtherCon RJ45 type, which is compatible with standard RJ45 cable connector. Straight (most common) as well as cross linked network cables can be used.**

**10/100 Base-T — RJ45 port**

Pin	Description
1	TXD+
2	TXD-
3	RXD+
4	—
5	—
6	RXD-
7	—
8	—

**Status lights**

Function	Color	Description
ETH act	green	When connected with an Ethernet
10/100	orange	When a 100 MB network is detected
IR	red	IR received but not acknowledged
	green	IR received and acknowledged
WiFi sel	orange	When WiFi is selected
ACT	green	When WiFi is connected with an Ethernet
ERR	red	See chapter "Getting started", topic "Status LEDs"

<b>Function</b>	<b>Color</b>	<b>Description</b>
PWR	orange	See chapter "Getting started", topic "Status LEDs"
LMP	orange	See chapter "Getting started", topic "Status LEDs"



## 5. GETTING STARTED

### Overview

- RCU & Local keypad
- Terminology overview
- Power on projector
- Switching to standby
- Power off projector
- Status LEDs
- Using the RCU
- Projector Address
- Source selection
- Alignment of a table mount HDF series projector
- Alignment of a ceiling mount HDF series projector

### 5.1 RCU & Local keypad

---

#### How controlling the projector ?

The projector can be controlled by the local keypad or by the remote control unit.

#### Location of the local keypad ?

The local keypad is located on the input side of the projector.

#### Remote control functions.

This remote control includes a battery powered infrared (IR) transmitter that allows the user to control the projector remotely. This remote control is used for source selection, control, adaptation and set up.

Other functions of the remote control are :

- switching between stand by and operational mode.
- switching to "pause" (blanked picture, full power for immediate restarting)
- direct access to all connected sources.

### 5.2 Terminology overview

---

#### Overview

The following table gives an overview of the different functionality of the keys.

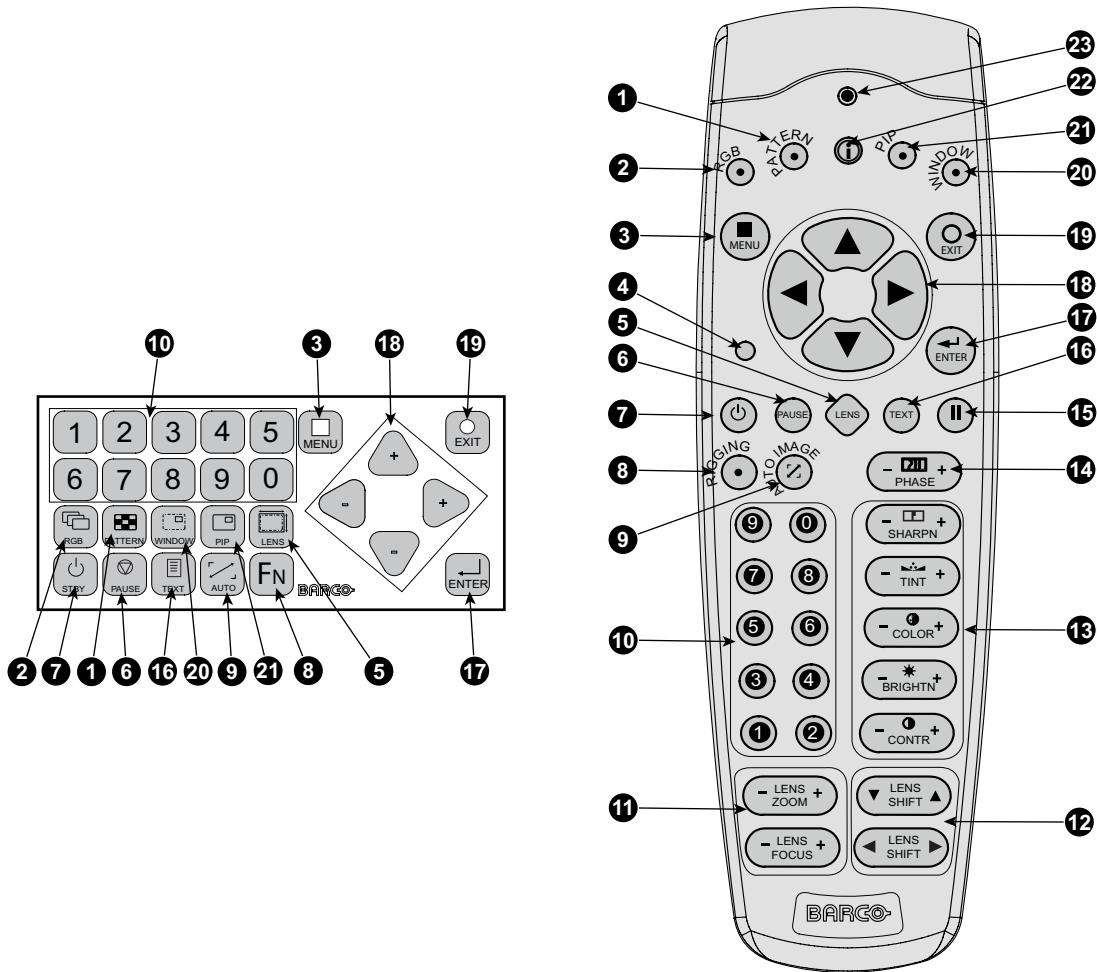


Image 5-1  
Local keypad and RCU

Ind.	Key name	Description
1	Pattern key	Direct access key to the internal pattern selection menu.
2	RGB	Toggle key to enable and disable colors in the adjustment mode. Toggle between red, green, blue and full RGB.
3	MENU	Access key to the menu structure and key to quickly quit the adjustment menus.
4	Address key	(recessed key), to enter the address of the projector (between 0 and 9) in the remote control. Press the recessed address key with a pencil, followed by pressing one digit button between 0 and 9.
5	LENS	Direct access key to the lens adjustment menus. Toggling this key will change the projected pattern.
6	PAUSE	To stop projection for a short time, press 'PAUSE'. The image disappears but full power is retained for immediate restarting. Shutter is closed.
7	STBY	Standby function switch off the lamp and lamp electronics. The lamp cooling fans remain active for about 5 minutes. The speed of the other fans is reduced.
8	F <sub>N</sub>	FN toggles the local display to preview an input
9	Auto	Auto alignment at first access.
10	Digit buttons	Direct input selection or numeric entries
11	Lens zoom/focus	Zoom and focus controls of the lens
12	Lens shift	Shift control of the lens, to shift the lens up/down or left/right
13	Picture controls	Use these buttons to obtain the desired picture level.
14	PHASE	Used to remove the horizontal instability of the image (usually for RGB source). It adjusts the phase of the pixel sampling clock relative to the incoming signal.
15	FREEZE	To freeze the actual projected image.

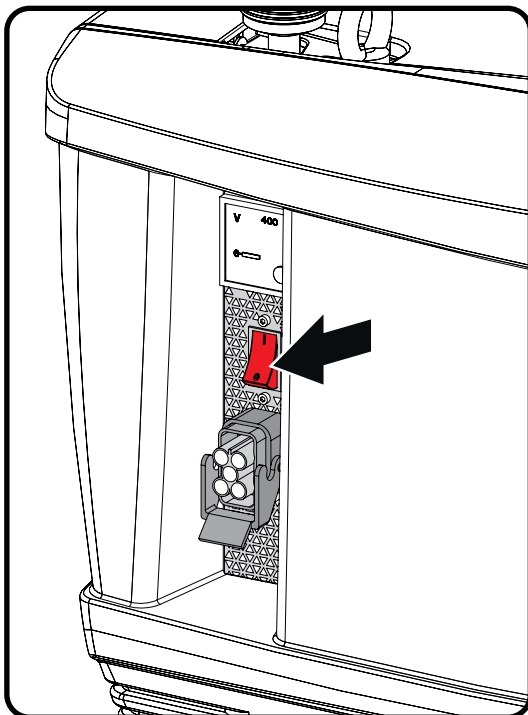
Ind.	Key name	Description
16	TEXT	Toggle key to activate or deactivate on screen text boxes while adjusting a setting.  When adjusting one of the image controls, e.g. during a meeting, the normally displayed bar scale can be deactivated by pressing 'TEXT' key first. To re-display the bar scale on the screen, press 'TEXT' key again. When TEXT is 'off', no adjustment menu's will be displayed on the screen when entering the adjustment mode. All menus and adjustments remain active on the local LCD panel.
17	ENTER	Key to confirm an adjustment or selection in the adjustment mode.
18	Cursor keys	To make menu selections when in the adjustment mode
19	EXIT	Key to go one menu stage higher than the actual position when in the adjustment mode.
20	WINDOW	Selection of the active window "Main" or "PiP"
21	PIP	Direct access key for picture in picture selection.
22	Info	Displays help information when on a certain menu item of the software
23	RC Operating indication	Lights up when a button on the remote control is pressed. (This is a visual indicator to check the operation of the remote control)

Table 5-1

### 5.3 Power on projector

#### How to power on.

1. Press the power switch at the back of the projector to switch on this projector.

Image 5-2  
Main switch

## 5. Getting started

---

- When '0' is pressed, the projector is switched off.
- When '1' is pressed, the projector is switched on.

The projector starts up in standby. The menus are accessible via the local LCD panel.

The start up screen is displayed on the local LCD panel and when fully started up, it changes to the overview screen. This screen indicates :

- the selected Main input
- the selected PIP input
- the IP address
- the Customer Id
- the Lamp status
- the Mains voltage
- the current ambient temperature
- the Text status (OSD)

To display an image, the standby key must be pressed once.



The current mains input voltage is indicated on the voltmeter just above the power switch.

---



The background image of the startup screen and info screens can be changed with Projector Toolset with an installed HDF series plug-in.

---

### Lamp overview

Once the projector is started, press **Lamp** to get an overview of the lamp parameters such as :



Image 5-3  
Local screen, lamp

- number of Strikes
- Run time in hours
- Remaining run time in hours
- slide bar indication with percentage indication of the current run time, compared with the maximum life time of the lamp.

### Software overview

Once the projector is started, press **About** to get an overview of the software versions such as :





Image 5-4  
Local screen, about

- Package version
- Mgr software
- GUI software

### Starting image projection via the standby key.

1. Press **Stand by** key once on the local keypad or on the remote control.

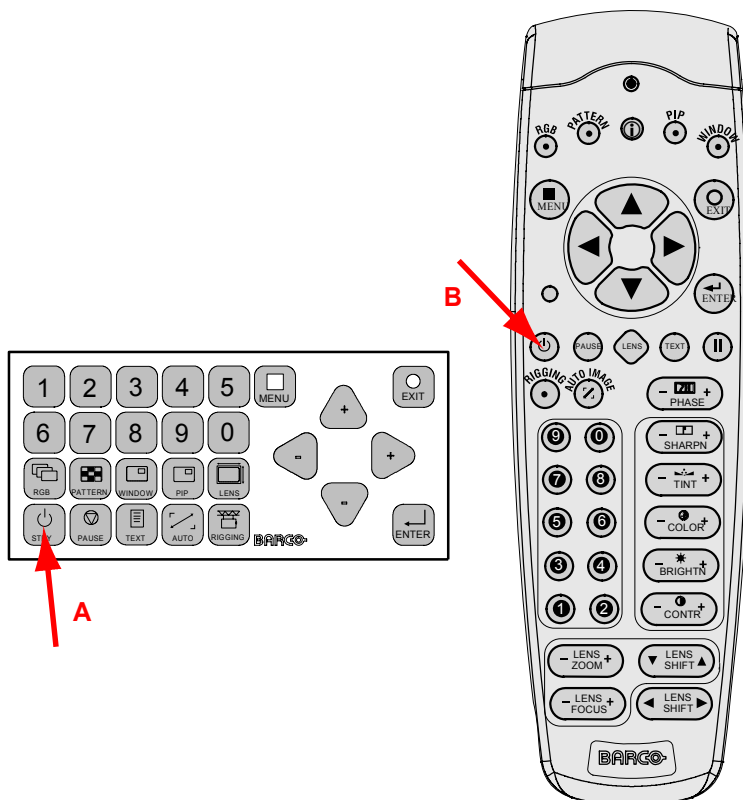


Image 5-5  
Stand by indication

- A Stand by indication on local keypad  
B Stand by indication on remote control

The projector status LED lights up.

The projector starts up on the last saved source.

Some lamp and runtime warnings can be displayed when an image is displayed after a start up.

## 5.4 Switching to standby

### How to switch to standby

1. Press and hold **Standby** for 3 seconds on the local keypad or the remote control. In the mean time the message *Keep on pressing...* is displayed. This message changes to *Saving data ...*

The projector goes to standby.



All custom settings are written to the internal backup device. A message 'Saving data ...' indicates this process. Never switch off the projector while this message is displayed.



When switching to standby, an after cooling process will start to cool down the projector. The after cool time depends on the temperature inside the projector and can vary from 30 second to 5 minutes.

## 5.5 Power off projector

### How to power off

1. Press first **Standby**.
2. Let cool down the projector until the fan speed decreases. At least 5 minutes.
3. Switch off the projector with the power switch. '0' must be pressed.



**CAUTION:** Never switch off the projector while the message 'Saving data ...' is displayed !

## 5.6 Status LEDs

### Overview

LED	Color status	Description
Standby button	Red on	Projector is in standby
	Red toggles on/off	Projector startup failed, no lamp power supply
	Green toggles on/off	Projector starts up
	Green on	Projector is on
	White toggles on/off	From/To ECO standby
	Dimmed white	Projector powers up
	Orange toggles on/off	Lamp power supply failed
Pause button	Red on	Shutter is closed
	Green on	Shutter is open
	Dimmed white	Shutter is closed, projector in standby
	Full white	Shutter is undefined (shutter not open and not closed)
	Full white toggles on/off	Shutter is closed during reset formatter
PWR (power LED)	Off	Projector powers up
	Red	Standby
	Orange	ECO standby
	Green	Projector is on

LED	Color status	Description
LMP (lamp LED)	Off	Lamp is off
	Red	No lamp inserted
	Orange	Lamp is on in ECO mode
	Green	Lamp is on in normal mode
	Green-Orange	Lamp is on in CLO mode
ERR (error LED)	Off	No error
	Red toggles on/off	Error
	Orange toggles on/off	Warning
IR	Red	IR signal received
	Green	IR signal acknowledged

## 5.7 Using the RCU

### Pointing to the reflective screen

1. Point the front of the RCU to the reflective screen surface.

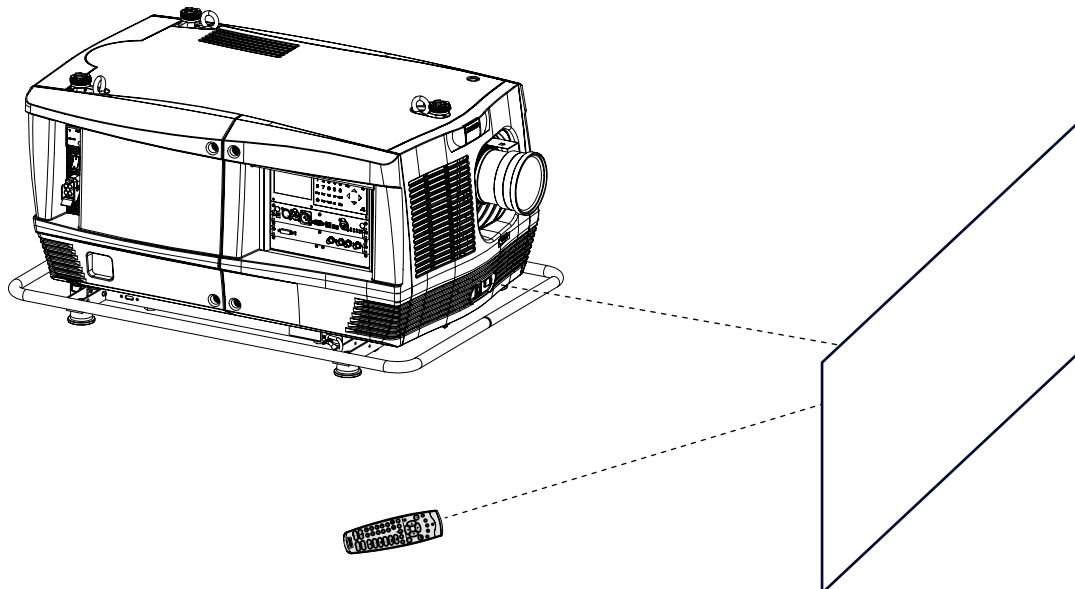


Image 5-6  
IR control via reflective screen

### Hardwired to the XLR input

1. Plug one end of the remote cable in the connector on the bottom of the RCU.
2. Plug the other end in the big connector on the communication interface of the projector, labelled **Remote CTRL**.

### Pointing directly to the IR sensor

When using the wireless remote control, make sure you are within the effective operating distance (30m, 100ft in a straight line). The remote control unit will not function properly if strong light strikes the sensor window or if there are obstacles between the remote control unit and the projector IR sensor.

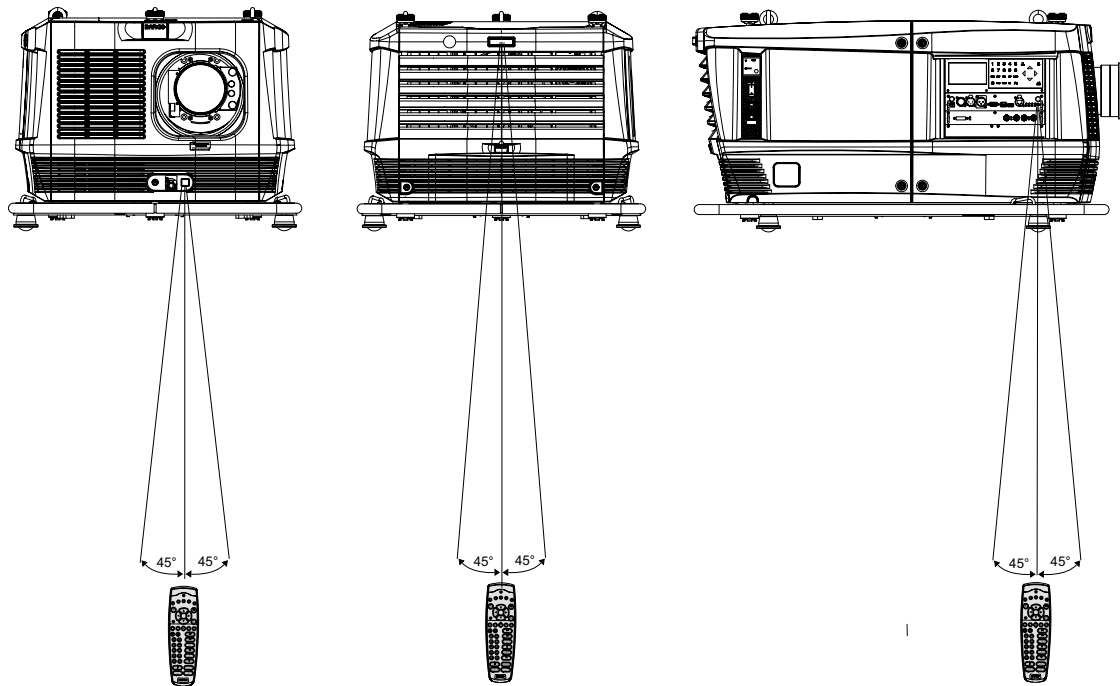


Image 5-7  
RCU to one of the IR sensors

## 5.8 Projector Address

### 5.8.1 Displaying and Programming addresses into the RCU

#### Displaying the Projector Address on the Screen.

1. Press **Address** key (recessed key on the RCU) with a pencil.

The projector's address is displayed on the local LCD screen.



To continue using the RCU with that specific address, it is necessary to enter the same address with the digit buttons (address between 0 and 9) within 5 seconds after pushing the address key. For example : if the Address key displays projector address 3, then press "3" digit button on the RCU to set the RCU's address to match the projector's address. Do not press 03. This will address the remote control to '0' and control all projectors in the room. If the address is not entered within 5 seconds, the RCU returns to its default address (zero address) and controls all projectors in the room.

#### How to Program an Address into the RCU?

1. Press the **Address** key (recessed key on the RCU) with a pencil.
2. Enter the address with the digit buttons within 5 seconds after pushing the address key.  
**Note:** That address can be any digit between 0 and 9.



The LED on the remote control must lit up while pressing a digit key. Otherwise the address is not entered in the remote control.

### 5.8.2 Controlling the projector



#### Projector address

Address installed in the projector to be individually controlled.



### Common address

Projector will always execute the command coming from a RCU programmed with that common address.

### Why a projector address ?

As more than one projector can be installed in a room, each projector should be separately addressable with an RCU or computer. Therefore each projector has its own address.

### Set up an individual Projector Address.

The set up of a projector address can be done via the software. See chapter 'Projector Control', 'Projector address'.

### Projector controlling.

Every projector requires an individual address between 0 and 255 which can be set in the Service mode.

When the address is set, the projector can be controlled now:

- RCU for addresses between 0 and 9.
- computer, e.g. IBM PC (or compatible), Apple MAC, etc. for addresses between 0 and 255.

### Common Address

Every projector has a common address '0' or '1'. The choice between '0' and '1' can be selected in *Projector Control* → *Projector address* → *Common address*.

## 5.9 Source selection

### Source selection when no picture in picture is active

Use the digit keys on the remote control or local keypad to activate the desired source.

### Source selection when picture in picture is active

Use the **Window** button on the remote control or the local keypad to select the main window or the picture in picture (PiP) window.

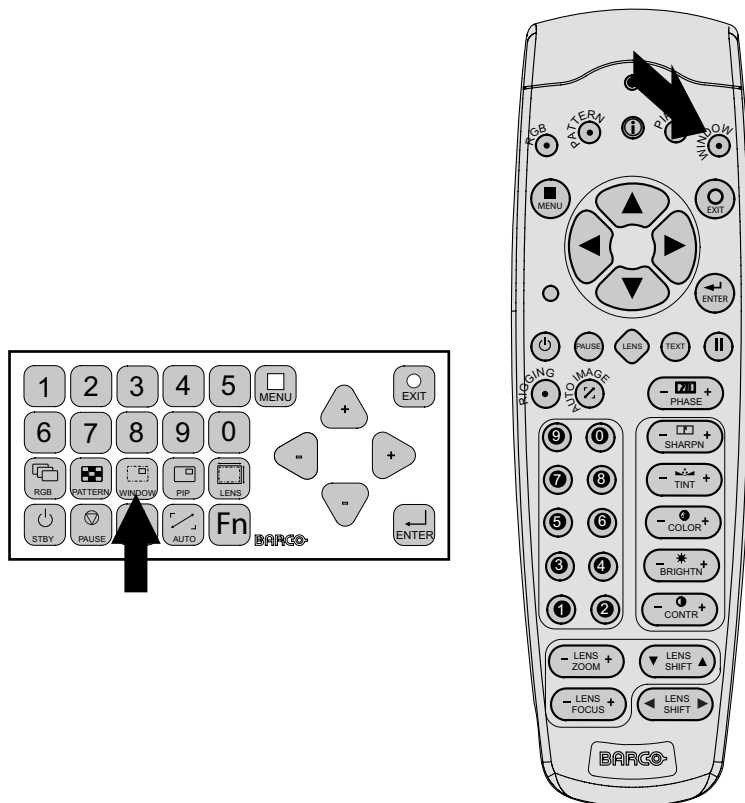


Image 5-8  
Window selection button

## 5. Getting started

The outline of the selected window gets a colored rectangle to indicate the selection. For the main window, the color is blue. For the picture in picture window, the color is orange.

Once the desired window is activated (main window or picture in picture window) all keys on the remote control or local keypad can now control that selected window.

To select the source for the picture in picture window, press Window button until PiP window is activated and then select the desired source with the digit keys.

To select the source for the main window, press Window button until the main window is activated and then select the desired source with the digit keys.

## 5.10 Alignment of a table mount HDF series projector

### How to align a table mount HDF series projector ?

1. Place the projector in the desired location. Take into account the zoom range of the used lens and the size of the screen.
2. Project one of the internal hatch patterns on the screen.
3. Turn the adjustable feet in or out until the projected hatch pattern is perfectly rectangle shaped and leveled.

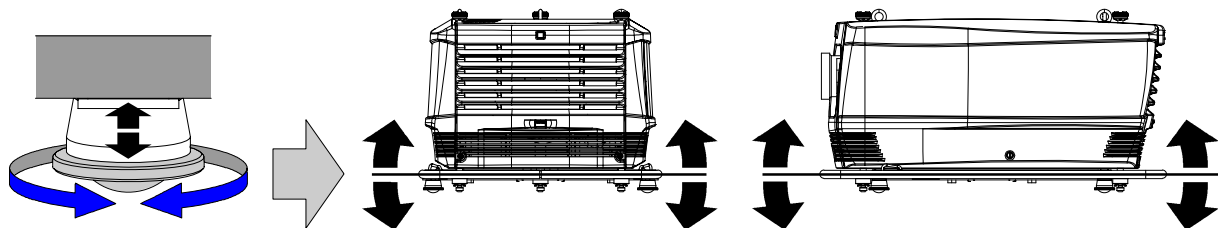


Image 5-9

When this is achieved, the projector is set horizontal and vertical at right angles to the screen.

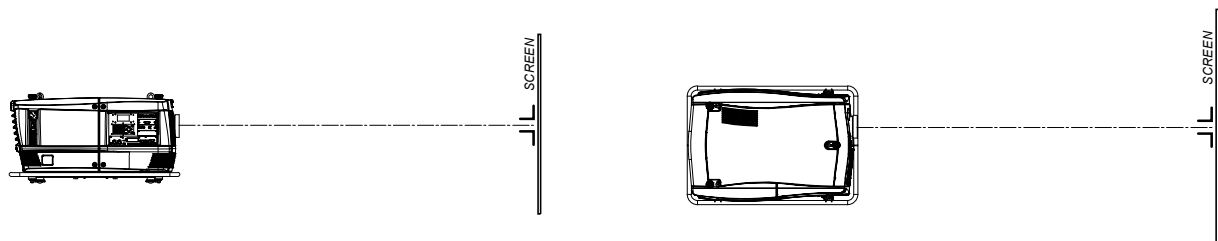


Image 5-10

## 5.11 Alignment of a ceiling mount HDF series projector

### Necessary tools

17 mm open ended spanner.

### How to align

1. Install the projector in the desired location. Take into account the zoom range of the used lens and the size of the screen.
2. Project one of the internal hatch patterns on the screen.
3. Release the lock nut (ref B image 5-11) of the rigging clamps.
4. Adjust the height of the rigging clamps with respect to the projector, until the projected hatch pattern is perfectly rectangle shaped and leveled.

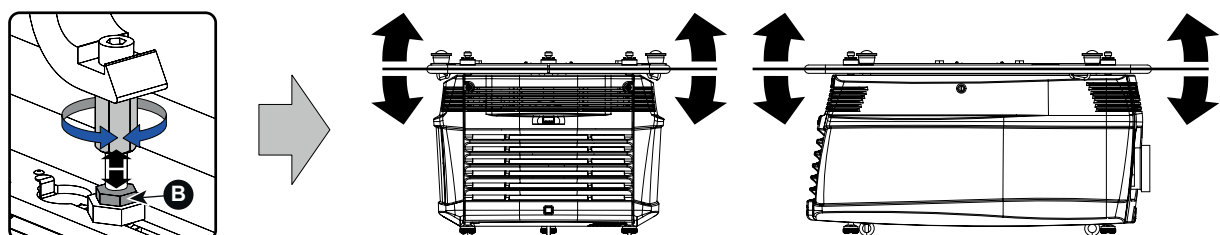


Image 5-11

When this is achieved, the projector is set horizontal and vertical at right angles to the screen.

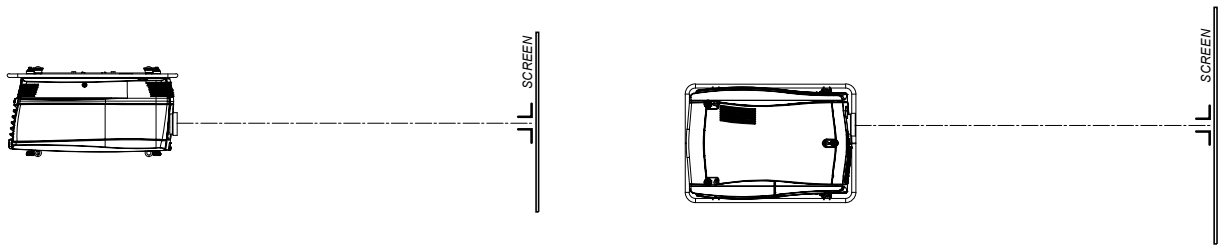


Image 5-12  
Level adjustment

5. Fasten the lock nut (B) of the rigging clamps.





## 6. QUICK SET UP ADJUSTMENT

### Overview

- Text boxes ON or OFF
- Quick Lens Adjustment via LENS key
- Direct Lens Adjustment (RCU)
- Quick picture in picture
- Quick language selection

### 6.1 Text boxes ON or OFF

#### Text toggle function

The on-screen text boxes can be switched OFF so that an adjustment during the operation of the projector is not visible on the screen. The adjustment indication remains visible on the local LCD screen.

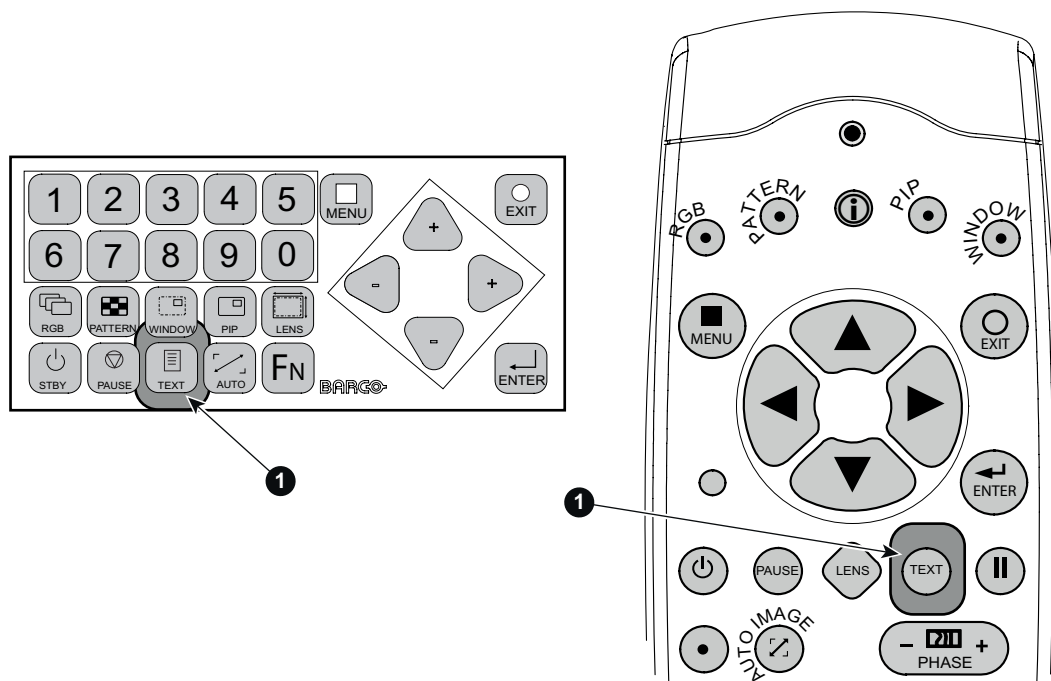


Image 6-1  
Text button

To toggle Text ON or OFF, press the **TEXT** key on the remote control or local keypad.

### 6.2 Quick Lens Adjustment via LENS key

#### Quick zoom/focus adjustment

1. Press the **LENS** key on the remote control or local keypad to open the *Zoom/Focus Adjustment* menu.

## 6. Quick set up adjustment

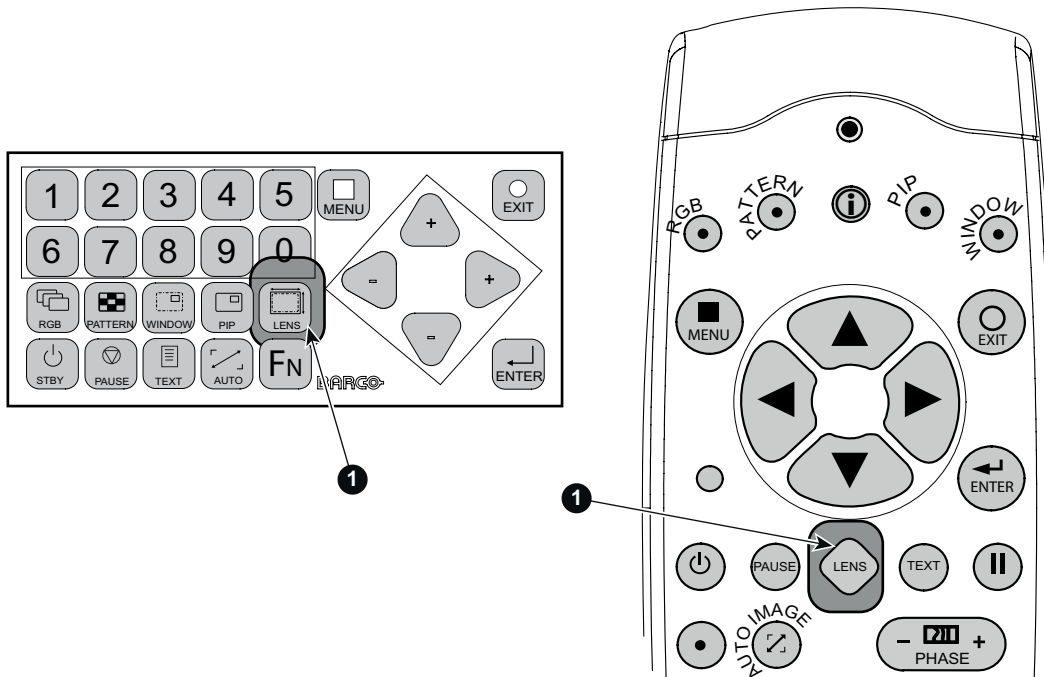


Image 6-2  
Lens button

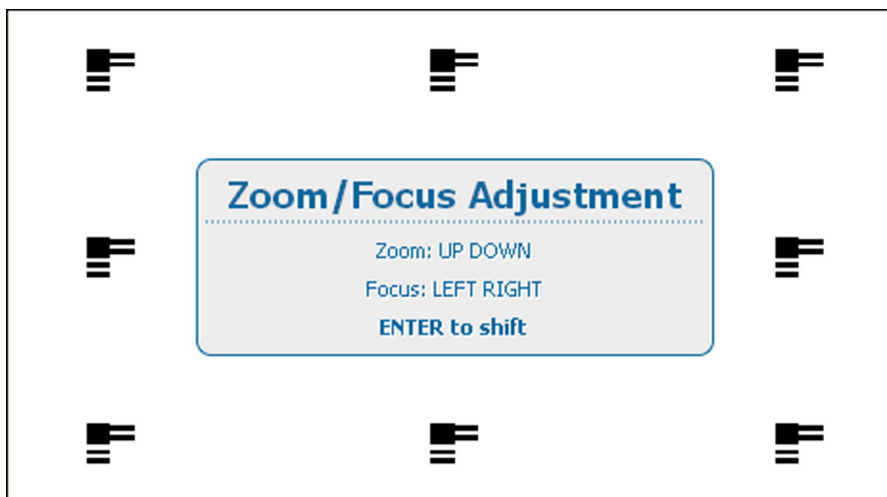


Image 6-3  
Zoom/Focus adjustment

2. Use the ▲ or ▼ key to zoom and ◀ or ▶ key to focus the image.
3. When finished, press **EXIT** key to return or **ENTER** to continue to the shift adjustment.



Press the **LENS** key to call the list with available test patterns.

### Quick shift adjustment

1. Press the **LENS** key on the remote control or local keypad to open the *Zoom/Focus Adjustment* menu.

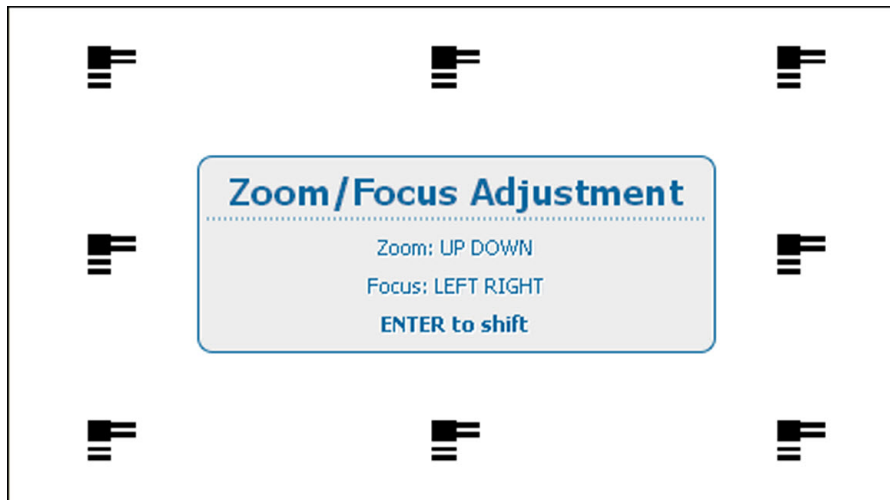


Image 6-4  
Zoom/Focus adjustment

2. Press **ENTER** to go to the *Shift* menu.

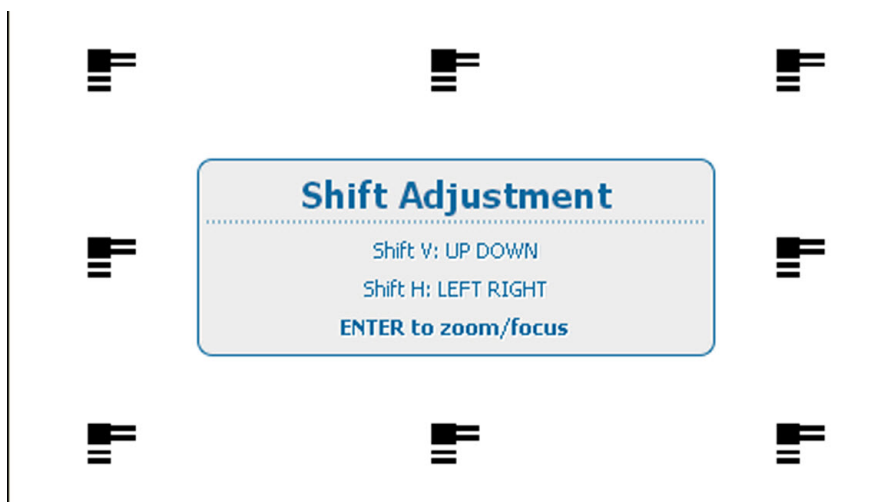


Image 6-5  
Shift adjustment

3. Use the ▲ or ▼ key to shift the lens in vertical direction.  
Use the ◀ or ▶ key to shift the lens in horizontal direction.  
Press **ENTER** to switch to zoom/focus adjustment.

### 6.3 Direct Lens Adjustment (RCU)

#### Lens adjustment buttons on the Remote Control

On the Remote Control four buttons with double action are provided, allowing direct alignment for lens ZOOM, FOCUS, HORIZONTAL SHIFT and VERTICAL SHIFT.

1. Press **LENS ZOOM** button [-] or [+] (A) for correct image size on the screen.

## 6. Quick set up adjustment

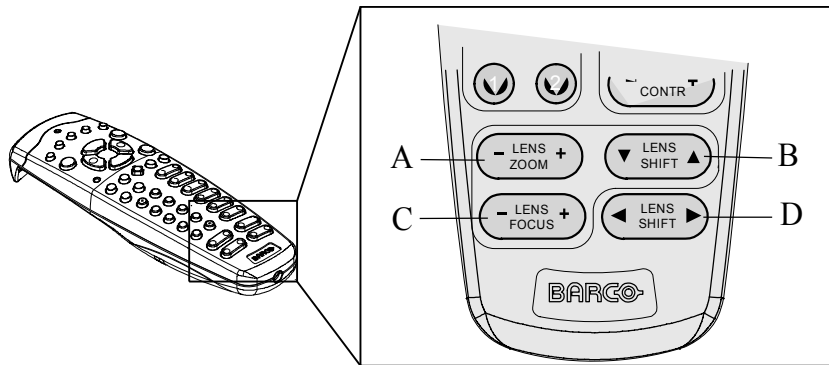


Image 6-6  
Direct lens adjustment keys

- A Zoom
- B Vertical shift
- C Focus
- D Horizontal shift

2. Press **LENS FOCUS** button [-] or [+] (C) for an overall focus of the image.
3. Press **▲ LENS SHIFT ▼** button for correct vertical position of the image on the screen.
4. Press **◀ LENS SHIFT ▶** button for correct horizontal position of the image on the screen.

## 6.4 Quick picture in picture

### Quick On - Off

Press on the **PIP** key on the remote control or the local keypad to activate the Load layout window.

Use the **▲ ▼** key to scroll to the desired layout and press **ENTER** to activate.



Select **Main full screen** to switch off PIP.



Image 6-7  
Load layout file list

## 6.5 Quick language selection

### Quick language selection via the remote control

When no OSD menu is visible on the screen, press the Info button (1) on the remote control.

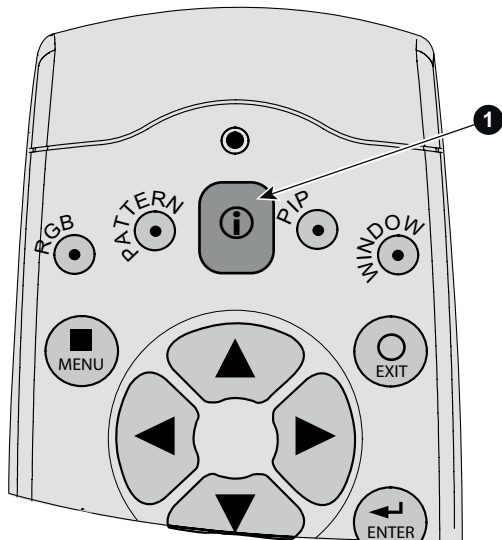


Image 6-8  
Info button

The language selection menu is displayed on the screen.

Select the desired language with the ▲ ▼ key and press **ENTER** to activate. The current active language is indicated with a selected radio button



Image 6-9  
Change language

### Language selection via OSD

1. Press **Menu** to activate the menus and select *Projector Control* → *Change Language*.
2. Press **ENTER** to open the language selection menu.
3. Select the desired language with the ▲ ▼ key and press **ENTER** to activate.

The current active language is indicated with a selected radio button

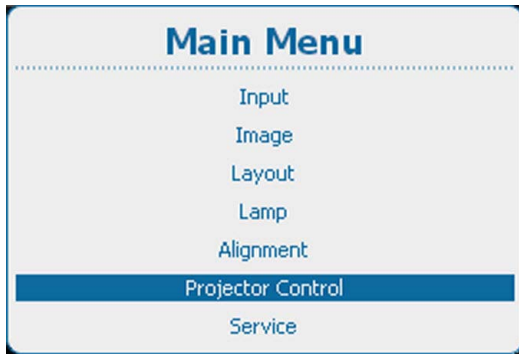


Image 6-10  
Main menu

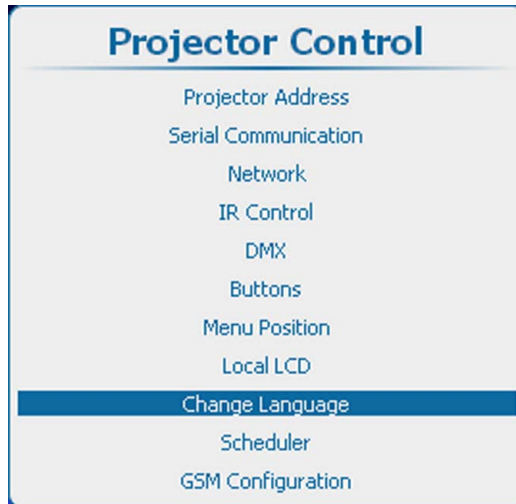


Image 6-11  
Projector Control



Image 6-12  
Change language

## 7. START UP OF THE ADJUSTMENT MODE

### Overview

- About the adjustment mode
- About the use of the remote control and the local keypad
- Start up the adjustment mode
- Navigation and adjustments
- Menu memory
- Shortcut keys to the menus
- Test patterns in adjustment mode
- Help information in adjustment mode

### 7.1 About the adjustment mode

---

#### Overview

As the adjustment mode is the central place to control and align the projector, the following functions can be done:

- Input setup: different Input settings can be adjusted such as specific input slot settings, locking, native resolution and no signal settings.
- Image adjustment: these adjustments are organized per image source and contain the aspect ratio, timings and image settings.
- Layout adjustment: set up of the main window and the picture in picture window.
- Lamp: manage the lamp mode, the lamp use, lamp type and history
- Alignment: groups all controls necessary during the setup of the projector onto a screen.
- Projector control: contains the accessibility settings of the projector, such as address and communication setup.
- Service: contains information about how the projector is performing. This information will be useful when calling for a service intervention.

### 7.2 About the use of the remote control and the local keypad

---

#### Overview

All navigations and adjustments can be done either with the remote control or with the local keypad.

Almost all the keys on the remote control have an equivalent on the local keypad.

Exceptions:

- Direct adjustment keys such as Contrast, Brightness, Saturation, Phase, etc.

### 7.3 Start up the adjustment mode

---

#### Start up tools

To start up the adjustment mode, use the remote control or the local keypad.

#### How to start up?

1. Press **Menu** on the remote control (RCU) or on the local keypad to start up the *Adjustment* mode.

## 7. Start up of the adjustment mode

The main menu of the adjustment mode opens.

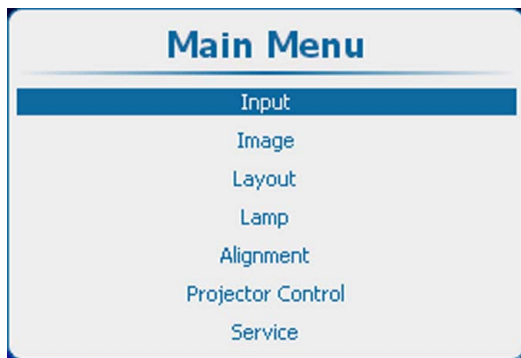


Image 7-1  
Main menu

## 7.4 Navigation and adjustments

### How to navigate in the menu structure?

Once in the menu structure, use the ▲ or ▼ key on the remote control or on the local keypad to scroll through the items in the displayed menu. The selected item will get a background color. To activate a selected submenu or function, press **ENTER**.

When on a submenu, to return one step to the parent menu, press **EXIT**.

To escape the menu structure when on a menu, press **MENU**.

### How to make an adjustment?

With the remote control or the local keypad navigate through the menu structure until the desired item is selected. Press the ▲ or ▼ key until the desired item is reached. Press **EXIT** to finalize the adjustment.

With the local keypad or remote control, press the ▲ or ▼ key until the desired value (setup) is reached. Press **EXIT** to finalize the adjustment.

Direct adjustment within the menu:

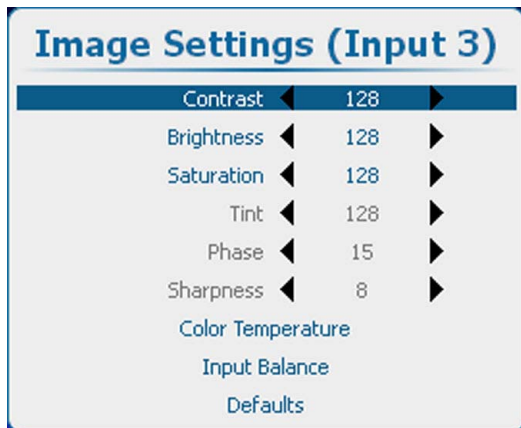


Image 7-2

Use the ◀ or ▶ key to directly adjust the current value.

or,

Via bar scale adjustment :

Once an item is selected, press **ENTER** to open the bar scale menu.

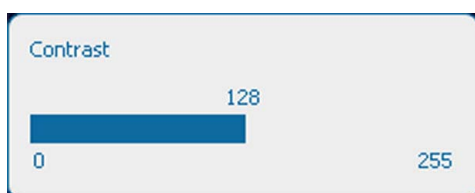


Image 7-3  
Contrast adjustment



Use the ◀ or ▶ key to adjust the current value.

The bar scale will move accordingly.

Press **EXIT** to finalize the adjustment.

or,

When the bar scale is displayed, via direct input. Press **ENTER** to activate the input field.

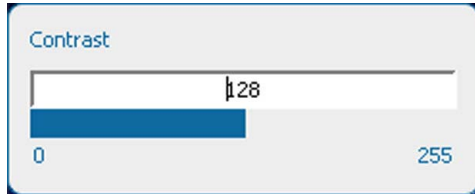


Image 7-4  
Direct contrast adjustment

Enter the desired value with the digit keys. Press **ENTER** to accept.

Press **EXIT** to finalize the adjustment.

## 7.5 Menu memory

### Overview

Each menu with sub menu, remembers its last selected sub item even when leaving the menu structure and that as long as the projector is running. When restarting the projector from stand-by, the menu memory is reset.

After re-opening the main menu and selecting an item, the previous selected sub item of that selected item is highlighted and can be opened just by pressing **ENTER**.

## 7.6 Shortcut keys to the menus

### About a shortcut key

The digit keys 5 to 9 can be customer programmed to directly open a pre-stored menu. That menu can be any independent menu out of the list of menus. A menu which is built up by the content of a previous menu cannot be stored behind a shortcut.

### How to use a shortcut key

While in the operational mode, no menu selected, just press on the desired digit key to open the menu behind that shortcut key.

### How to create a shortcut key

Scroll to the desired menu. Press the digit key behind which the menu must be stored for 5 seconds. When the creation is successfully, a confirmation message appears on the screen. E.g. :

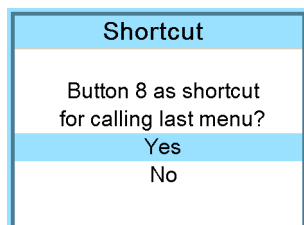


Image 7-5

Select **Yes** to confirm the creation.



To erase the shortcut, navigate to *Projector Control* → *Buttons*.

## 7.7 Test patterns in adjustment mode

### Overview

When the adjustment mode is started, a test pattern can be called at any moment just by pressing the **Pattern** key on the RCU or the local key path. Press as many times on the **Pattern** key as necessary to display the desired test pattern. The test pattern remains on the screen as long as the adjustment mode is selected, even when selecting other menus. When leaving the adjustment mode, the selected test pattern is cleared and the normal image is displayed again.

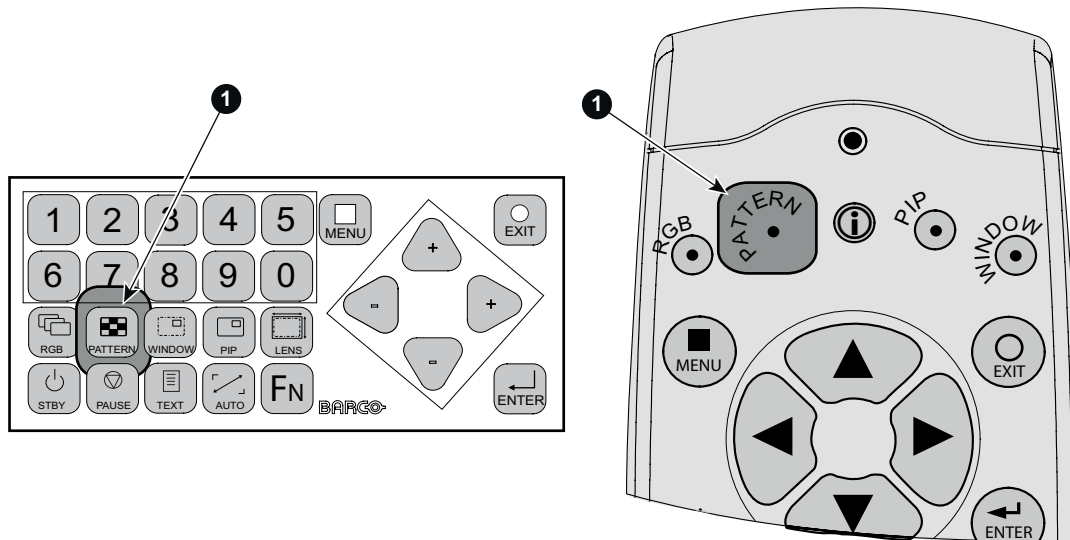


Image 7-6  
Pattern button

## 7.8 Help information in adjustment mode

### Overview

For many items in the adjustment mode, help information is available. When on an item, just click on the info button of your remote control to display information about the selected item.

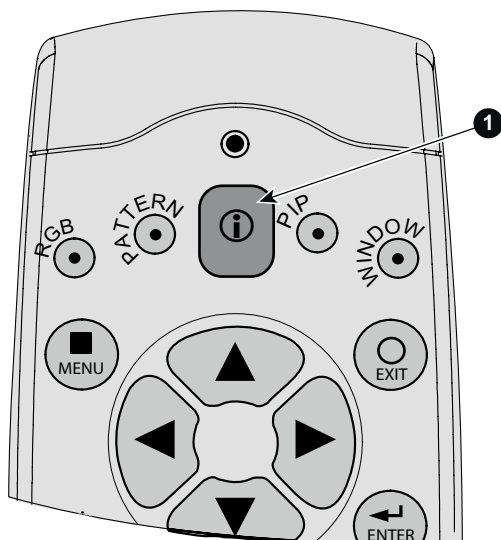


Image 7-7  
Info button

When no information is available for the selected item, the message *No help available for this item* is displayed.

To return to the adjustment mode, press **EXIT**.

## 8. INPUT

### Overview

- Input menu overview
- Input Selection
- Advanced Settings
- Input locking
- Minimum delay
- Native resolution
- No Signal
- EDID
- 3D input



In all cases, the minimum input frequency for 3D is 23 Hz per eye. Below this frequency the image will not be displayed correctly.

### 8.1 Input menu overview

#### Overview table

Level 1	Level 2	Level 3	Level 4
Input			
	Input Selection	DVI/RGB SDI (SD/HD/3G/Dual) Optional input 1 Optional input 2	
	Advanced Settings	DVI/RGB	DVI DVI Dual link RGB HS-VS YUV HS-VS AUTO
		SDI (SD/HD/3G/Dual)	Input 1 Priority Input 2 Priority Input 1 Input 2 DUAL SDI
	Input Locking	Input on Main Window Input on Pip Window Input 1 Input 2 Input 3 Input 4 Free Run Free Run Options	
	Minimum delay		
	Native Resolution [On/Off]		
	No Signal	Color [black/blue]	

	Logo [On/Off]	
	Shutdown [Off/On]	
	Shutdown time	
	Auto dimming [On/Off]	
EDID	Configure	
	Create	
	Delete	
	Delete All	
3D	Status	
	Auto Detection	
	Input type	Frame sequential - Single channel Frame sequential - Dual channel Frame packing (FHD3D) Side-by-side Top-and-bottom SENSIO® HI-FI 3D Line Alternating (3G)
	Second input	

## 8.2 Input Selection

### How to select

1. Press **Menu** to activate the menus and select *Input* → *Input Selection*.
2. Press **ENTER**.  
The *Select Source* menu is displayed with the actual available sources filled out.
3. Use the **▲** or **▼** key to select an input.

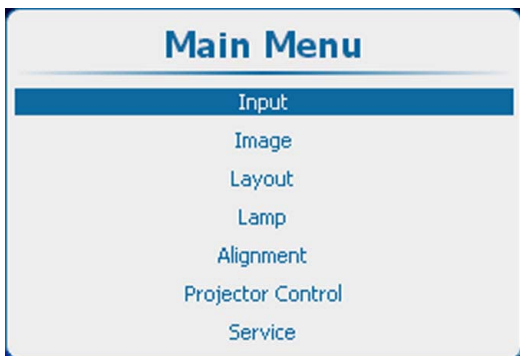


Image 8-1  
Main window



Image 8-2  
Input selection

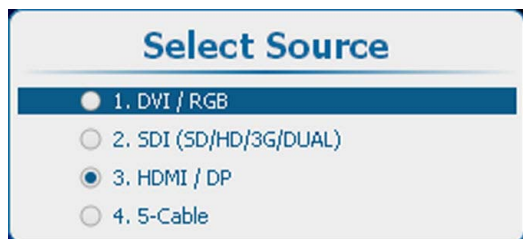


Image 8-3  
Select source

## 8.3 Advanced Settings

### Overview

- About Input Setup
- Input configuration
- DVI - RGB input
- SDI input
- 5 cable input
- HDMI - DisplayPort input (3D input module)

### 8.3.1 About Input Setup

#### Overview

Each input module must be configured before these module can be used. This configuration is necessary so that the projector knows which type of signal is connected to its input.

The projector has 4 input slots. Slot 1 and 2 is filled up by default with a DVI and Dual SDI input. Slot 3 and 4 can be filled up with optional input modules. Identical modules are allowed.

### 8.3.2 Input configuration



3D item in the Input menu is grayed out when no 3D module is inserted in slot 3 or 4.

#### How to change?

1. Press **Menu** to activate the menus and select *Input* → *Advanced Settings*.
2. Press **ENTER**.  
The Advanced Settings window is displayed with the actual situation filled out.
3. Use the **▲** or **▼** key to select an input  
Press **ENTER** to open the selection menu which will be different from input type to input type.

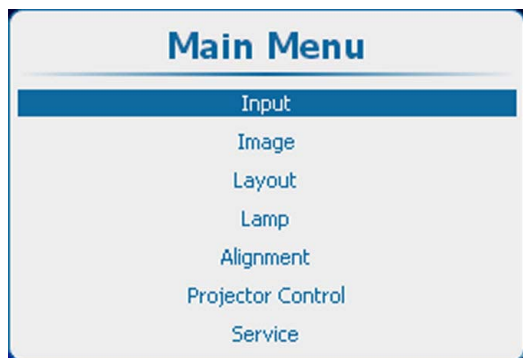


Image 8-4  
Main window

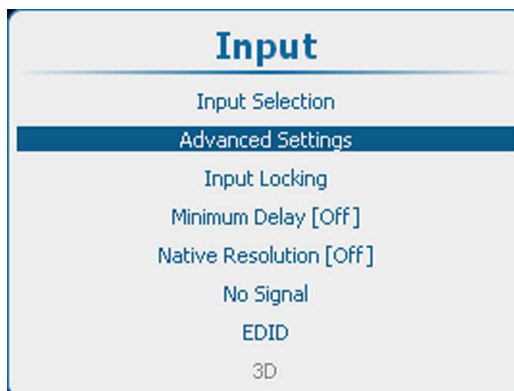


Image 8-5  
Advanced input settings

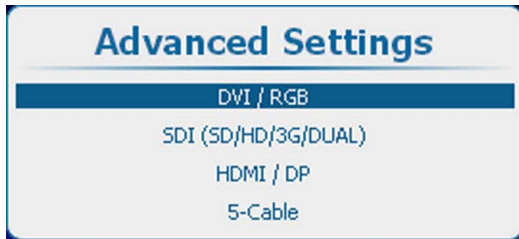


Image 8-6  
Advanced settings, input selection

### 8.3.3 DVI - RGB input

#### How to select

Select DVI / RGB and press **ENTER** to open the selections

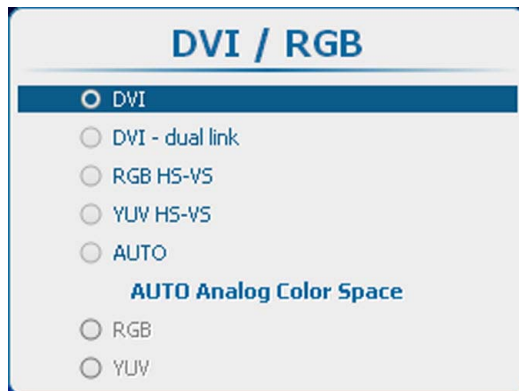


Image 8-7  
DVI selection

The following selections are possible:

- DVI
- DVI - dual link
- RGB HS-VS/CS
- YUV HS-VS/CS
- AUTO



**DVI will not natively support 10-bit or 12-bit deep color. It is possible to enable 30-bit color over DVI using a specific pixel packing. We support the pixel-packing that is implemented by Silicon Image Sil7189 DVI receiver.**

#### About AUTO selection

When AUTO is selected, the input source is automatically detected (only for DVI, RGB or YUV). When an analog source is detected in AUTO mode, then the Color Space must be selected as no automatic detection is possible.

Use the **▲** or **▼** key to select the correct color space and press **ENTER** to select.



Image 8-8  
Color space selection for AUTO

### 8.3.4 SDI input

#### About SDI input

The Dual SD/HD/3G-SDI Input can accept standard-definition (SD), high-definition (HD) and 3 Gigabit-definition serial-digital-interface (SDI) signals .

#### How to select

Select SDI (SD / HD / 3G / Dual) and press **ENTER** to open the selections



Image 8-9  
SDI, input type selection

The following selections are possible:

- Input 1 Priority (when 2 sources are present, the source on input 1 will have the priority)
- Input 2 Priority (when 2 sources are present, the source on input 2 will have the priority)
- Input 1
- Input 2
- Dual SDI

#### SDI setup

To set up the SDI input, select *Setup* and press **ENTER**.

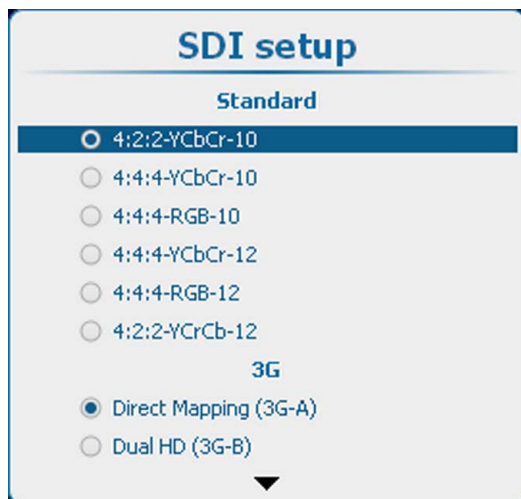


Image 8-10  
SDI set up

First, select the standard. Use the **▲** or **▼** key to select and press **ENTER** to accept.

Standard :

- 4:2:2 - YCbCr-10
- 4:4:4 - YCbCr-10
- 4:4:4 - RGB-10
- 4:2:2 - YCbCr-12
- 4:4:4 - YCbCr-12
- 4:4:4 - RGB-12

Then, select the 3G setting. Use the **▲** or **▼** key to select and press **ENTER** to accept.

## 8. Input

3G-A and 3G-B:

- Direct Mapping (3G-A)
- Dual HD (3G-B)

When Dual HD is selected, it is possible to use Swap links. If Swap links must be used, use the ▲ or ▼ key to select and press **ENTER** to accept. The check box will be checked.

Dual HD :

- Swap links

### 8.3.5 5 cable input

#### How to select

Select 5 cable and press **ENTER** to open the selections

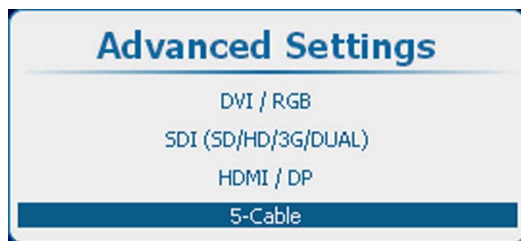


Image 8-11  
Advanced settings, 5-cable

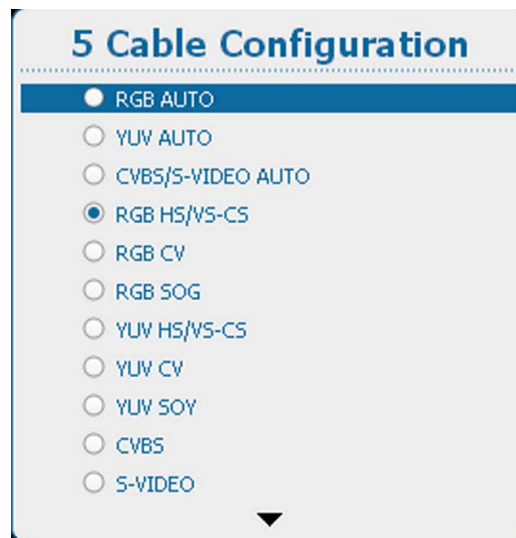


Image 8-12  
5 cable configuration

Use the ▲ or ▼ key to select the desired configuration and press **ENTER** to select.

When e.g. CVBS/S-VIDEO AUTO is selected, the projector discovers itself which type of signal is connected to it and loads the correct settings.

For RGB selections, advanced settings are possible. To adjust these advanced settings, use the ▲ or ▼ key to select *Advanced settings* and press **ENTER**. The advanced settings menu opens:

Press **ENTER** to toggle between [Analog] and [TTL].

### 8.3.6 HDMI - DisplayPort input (3D input module)

#### How to select

Select HDMI/DP and press **ENTER** to open the selections



Image 8-13  
HDMI-Display port selection

Use the ▲ or ▼ key to select the desired input and press **ENTER** to select.



## 8.4 Input locking

### What is possible?

The output signal can be locked on an internal sync signal or on the sync signal of one of the input sources. Or it can follow the input of the Main window or Pip window. When locked to the corresponding input sync, the output will be shown without movement artifacts. With locking to a specific input, a set of projectors can be kept in sync, no matter what input image is shown.



Input locking is grayed out when 3D is active. Input locking is set automatically to the 3D source.

### How to set up

1. Press **Menu** to activate the menus and select *Input* → *Input locking*.
2. Press **ENTER**.

The Input locking window is displayed with the current selection.

3. Use the **▲** or **▼** key to select a input to lock on.

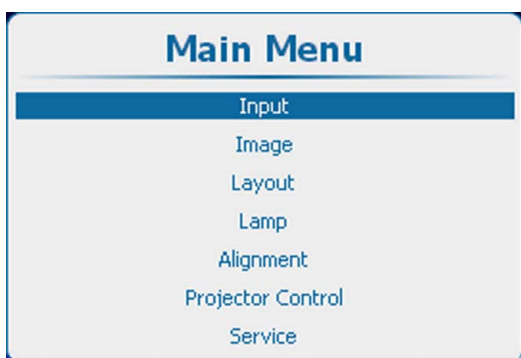


Image 8-14  
Main window

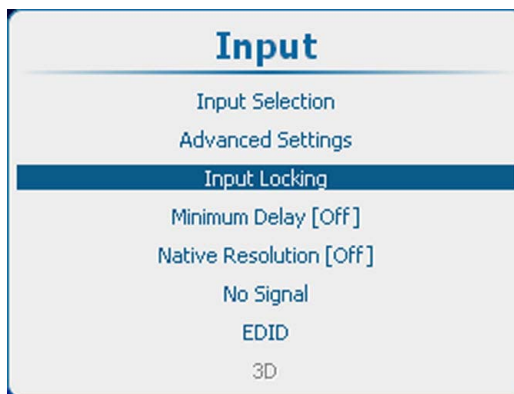


Image 8-15  
Input



Image 8-16  
Input locking

Input on Main window	Output is locked on the selected source of the main window
Input on PIP window	Output is locked on the selected source of the Pip window
Input 1	Output is locked on input 1
Input 2	Output is locked on input 2
Input 3	Output is locked on input 3
Input 4	Output is locked on input 4
Free run	Output is locked on an internal sync (60 Hz or manual setup)



When Input locking is set to a specific input and there is no sync signal available, the locking will be switched to Free run without changing the user settings. Once the sync is available, it applies again the user settings.

### Options for Free Run

When free run is selected, radio button selected, then the Free Run Options become available.



Image 8-17  
Free run options

Use the ▲ or ▼ key to select *Fixed 60 Hz* or *Manual* and press **ENTER** to select.

Fixed 60 Hz:	locking is done on an internal sync of 60 Hz
Manual	locking is done on the indicated vertical frequency which can be changed by the user (between 24 Hz and 60 Hz).

To change the locking frequency for Manual, use the ▲ or ▼ key to select *Vert freq* and press **ENTER** to activate.



Image 8-18  
Free run, manual setting

Use the ▲ or ▼ key to change the value.

## 8.5 Minimum delay

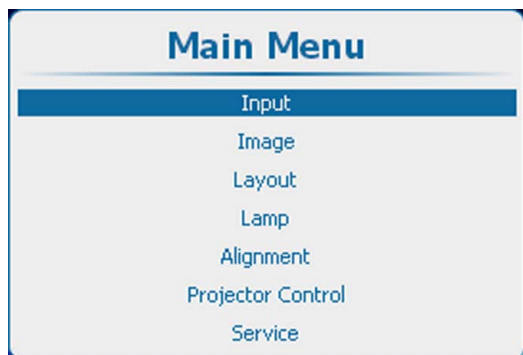
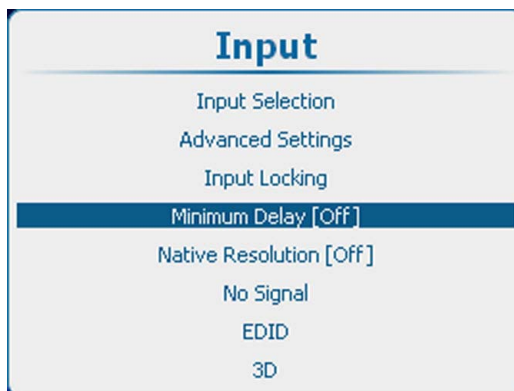
### Purpose

The minimum delay only affects the de-interlacing. In case of interlaced sources, the de-interlacer will be bypassed and the image will be shown with line interpolation applied.

To ensure minimum delay in the other processing steps, make sure warping is OFF, the resolution of the input source is native and the input locking is set to the main input.

### How to toggle the delay

1. Press **Menu** to activate the menus and select *Input* → *Minimum delay [On]*.

Image 8-19  
Main windowImage 8-20  
Input, minimum delay

2. Press **ENTER** to toggle between [On] and [Off].
- [On] : images displayed with minimum delay
- [Off] : images displayed without minimum delay

## 8.6 Native resolution

### What can be done

The aim here is to always show the resolution of the source independently of the resolution of the DMD panels.

When the resolution of the source is exactly the resolution of the DMD panels, then the full content will be shown on the full DMD (A).

When the resolution of the source is higher than the resolution of the DMD panels, then only part of the image will be shown (B)

When the resolution of the source is lower than the resolution of the DMD panels, then the full image will be shown but only on part of the DMD is used.

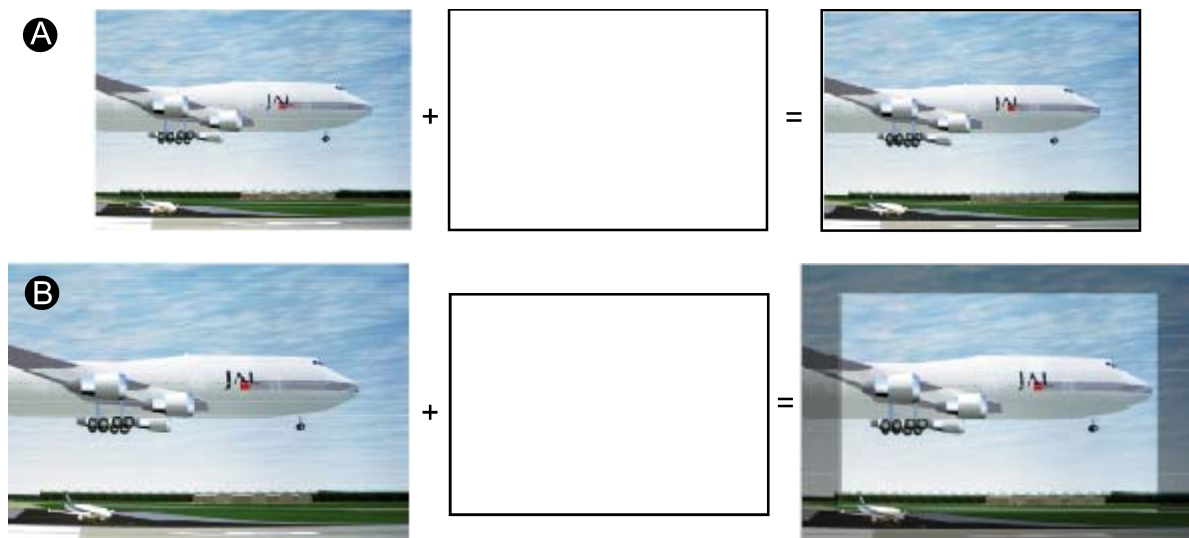


Image 8-21

When the *show native resolution* function is in the ON position, the projector handles the source as follows:

Source			Projected image		
Name	Ratio	Resolution	Ratio	Resolution	
XGA	4:3	1024x768	4:3	1024x768	image projected with black borders
SXGA	5:4	1280x1024	5:4	1280x1024	image projected with black borders
SXGA+	4:3	1400x1050	4:3	1400x1050	image projected with black borders

Source			Projected image		
UXGA	4:3	1600x1200	4:3	1600x1200	image projected with black borders left and right.
WUXGA	16:10	1920x1200	16:10	1920x1200	normal image projected

### How to toggle to native resolution?

1. Press **Menu** to activate the menus and select *Input* → *Native Resolution* [On].
2. Press **ENTER** to toggle between [On] and [Off].  
 [On] : images displayed in native resolution  
 [Off] : images scaled to fill the complete screen

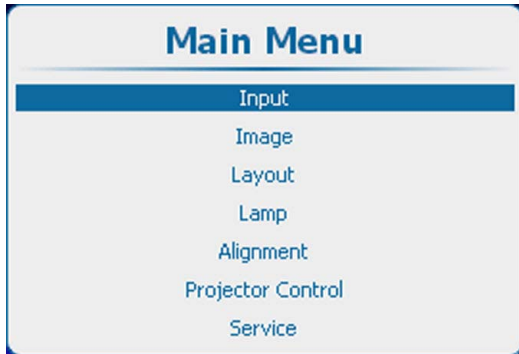


Image 8-22  
Main window

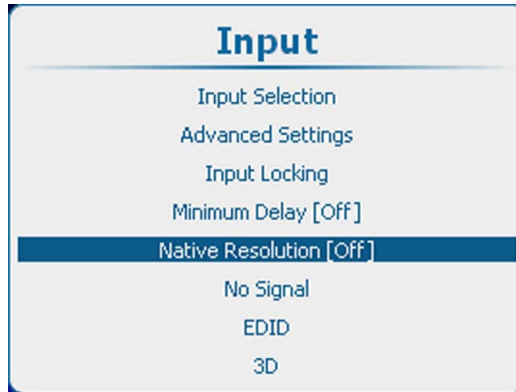


Image 8-23  
Input, native resolution

## 8.7 No Signal

### Overview

- Background color
- Background Logo
- Shutdown settings
- Shutdown retarding time
- Auto Dimming

### What can happen when no signal

When no signal is available at the selected input, the output can be set to blue or black or a personal defined logo can be displayed or the projector can shutdown after a certain time or auto dimming can be started.

#### 8.7.1 Background color

##### How to set the background color

1. Press **Menu** to activate the menus and select *Input* → *No Signal*. → *Color*.
2. Press **ENTER** to toggle between [Blue] or [black].

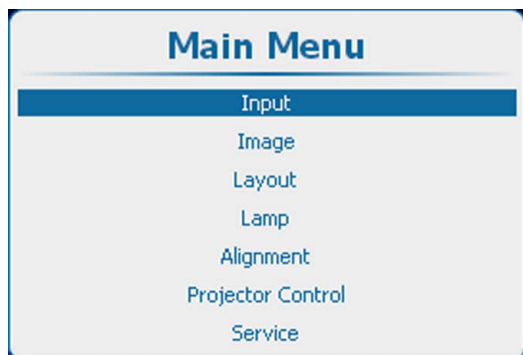


Image 8-24  
Main window

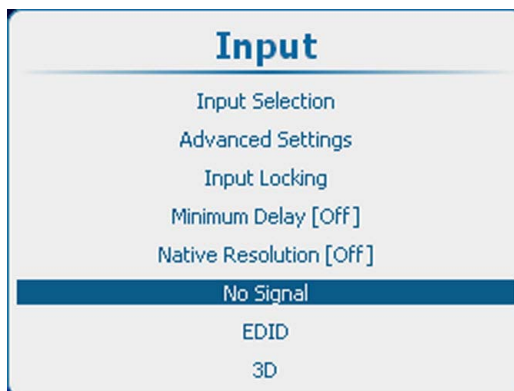


Image 8-25  
Input, no signal

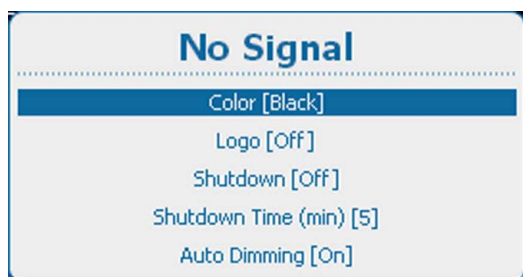


Image 8-26  
No signal, color

## 8.7.2 Background Logo

### What can be done ?

A logo can be switched on or off.

When logo is switched on and a logo is available, that logo will be displayed when no signal is available for the main window and no signal available for the PiP window in case PiP is On.

### How to activate logo

1. Press **Menu** to activate the menus and select *Input* → *No Signal*. → *Logo*.
2. Press **ENTER** to toggle between *[On]* or *[Off]*.

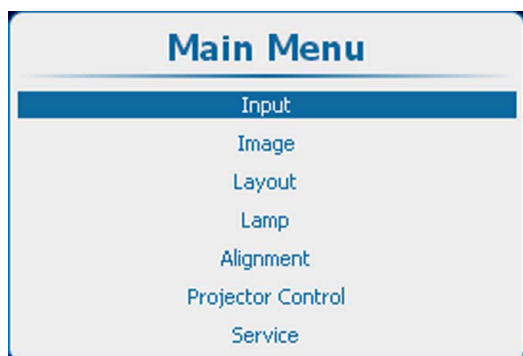


Image 8-27  
Main window

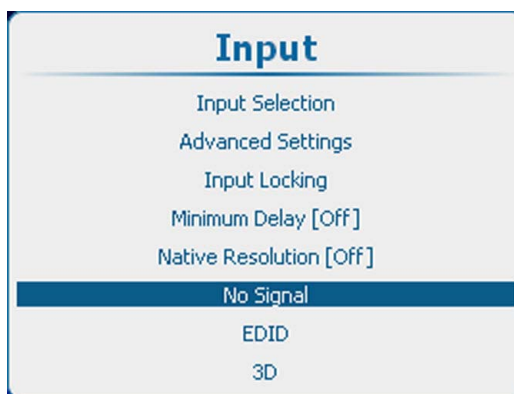


Image 8-28  
Input, no signal

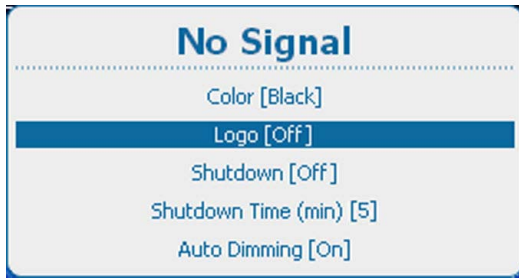


Image 8-29  
No signal, logo



A dedicated logo can be loaded via Projector Toolset with a HDF series plug-in installed.

### 8.7.3 Shutdown settings

#### How to change the settings

1. Press **Menu** to activate the menus and select *Input* → *No Signal*. → *Shutdown*.

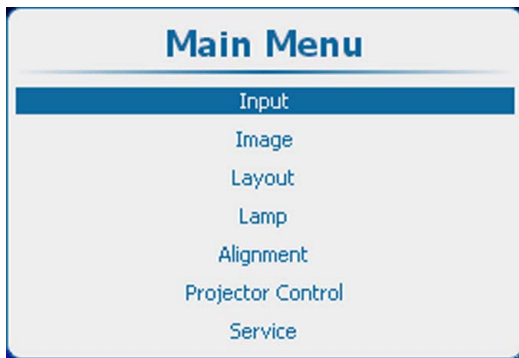


Image 8-30  
Main window

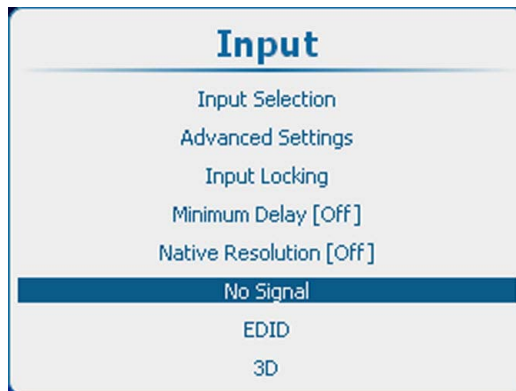


Image 8-31  
Input, no signal

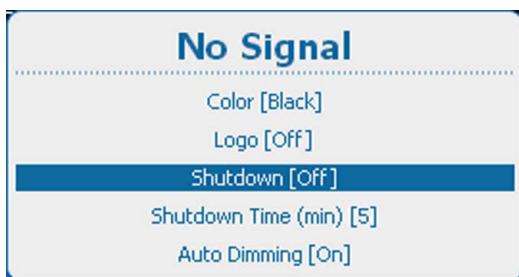


Image 8-32  
No signal, shutdown

2. Press **ENTER** to toggle between *[On]* and *[Off]*.  
*[On]*: projector goes in shutdown after a certain retarding time.  
*[Off]*: projector does not go in shutdown.

### 8.7.4 Shutdown retarding time

#### About the shutdown retarding time

The retarding time is the time between no signal is detected and the moment that the projector shuts down.

#### How to set the retarding time

1. Press **Menu** to activate the menus and select *Input* → *No Signal*. → *Shutdown time (min)*.

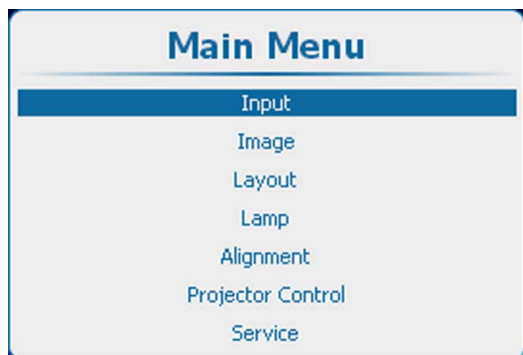


Image 8-33  
Main window

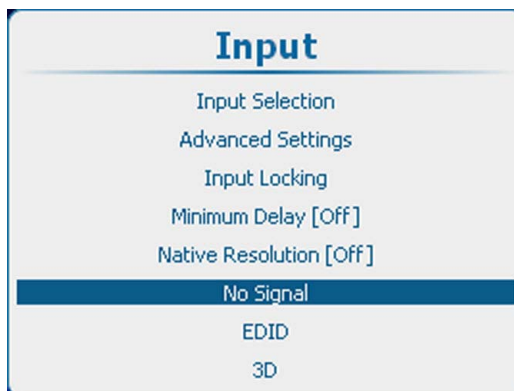


Image 8-34  
Input, no signal



Image 8-35

2. Press **ENTER** to toggle between [1], [3], [5] and [10] minutes.

### 8.7.5 Auto Dimming

#### About auto dimming

When no signal is detected on the selected input the lamp power will be reduced from the current value to its minimum value. When the input signal is re-detected, the lamp power is restored to its original value.

#### How to set up

1. Press **Menu** to activate the menus and select *Input* → *No Signal*. → *Auto Dimming*.

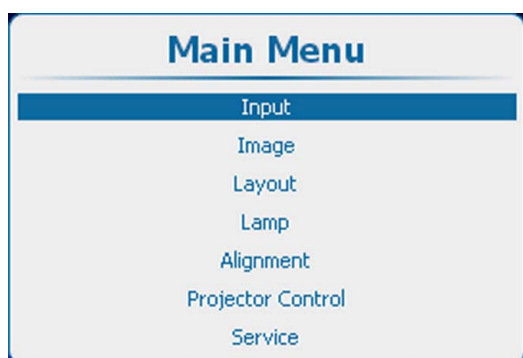


Image 8-36  
Main window

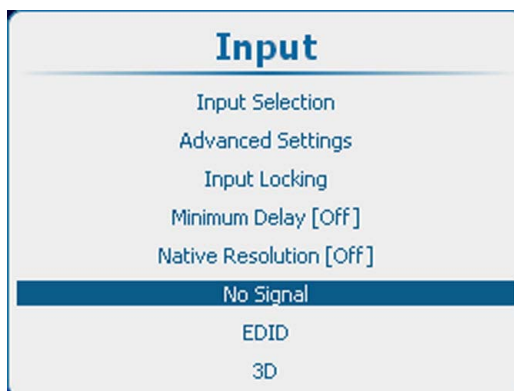


Image 8-37  
Input, no signal

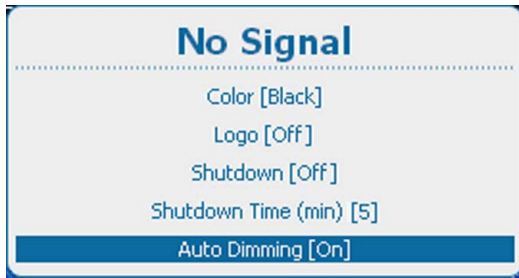


Image 8-38  
No signal, auto dimming

2. Press **ENTER** to toggle between *[On]* or *[Off]*.  
[On] : when no signal, auto dimming is started.  
[Off] : when no signal, no auto dimming is started.

## 8.8 EDID

---



### EDID

Extended Display Identification Data

---

### About EDID

The EDID file available for DVI input connectors includes timings supported by the projector; display size and other information about the display (i.e. projector). It is the set of information that is used by digital sources connected to the projector to generate a suitable image signal.

From the OSD, you can for each DVI input connector choose to use the Standard EDID file or create and force your custom made EDID file. The selection of the EDID file to be used is made in the *Configure* menu. Making your own custom EDID file(s) is done through *Create*. Custom EDID files can be deleted at any time.



The Standard EDID includes two timings: **1920x1200@60Hz / 1920x1080@60Hz** (for HDX, HDF and APOLLO projectors) and **2048x1080@60Hz / 1920x1080@60Hz** (for HDQ projectors).

---

### Overview

- Configure an input
- Create custom EDID file
- Delete a custom EDID file
- Delete all custom EDID file

### 8.8.1 Configure an input

#### Description

Selecting the Standard EDID file or an own created file can be selected from the list of Custom EDID files for the input.

#### How to configure

1. Press **Menu** to activate the menus and select *Input* → *EDID* → *Configure*.
2. Press **ENTER** to open the EDID configuration menu.



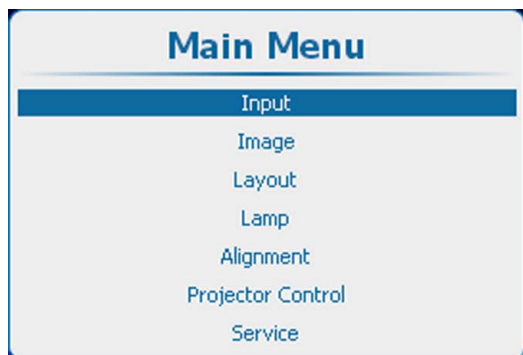


Image 8-39  
Main window

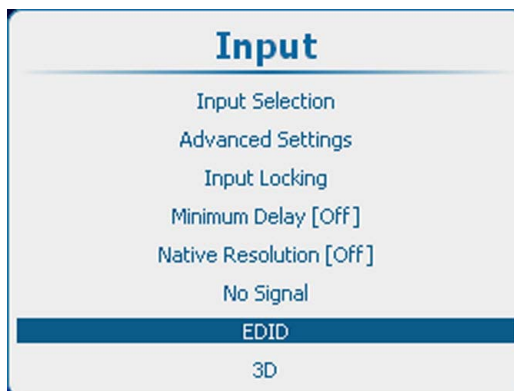


Image 8-40  
Input, EDID



Image 8-41  
EDID, configure

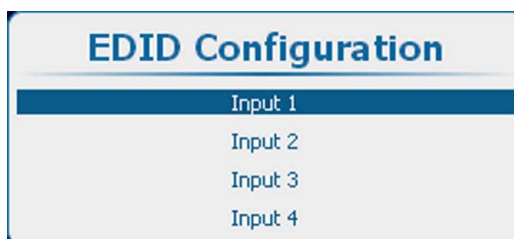


Image 8-42  
EDID configuration

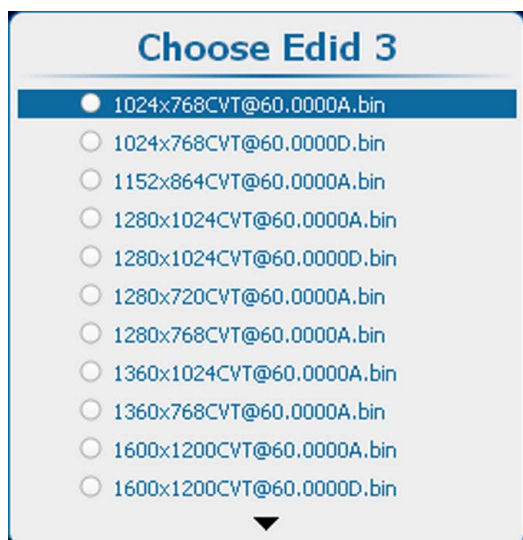


Image 8-43  
EDID selection list

- Use the ▲ or ▼ key to select the input to configure.  
Press **ENTER** to open the selection list.

The current active file is checked.

- Use the ▲ or ▼ key to select the correct file.  
Press **ENTER** to select this file.  
Press **EXIT** to return to the *EDID Configuration* menu.

- Use the ▲ or ▼ key to select **Apply**.

Your selection is applied and stored for this input.

The *EDID Configuration* menu remains open to configure another input.

Or,

use the ▲ or ▼ key to select **OK**.

Your selection is applied and stored for this input and the *EDID configuration* menu is closed.

## 8.8.2 Create custom EDID file

### Description

You can create new custom EDID files and enter the desired input timings.

### How to create

1. Press **Menu** to activate the menus and select *Input* → *EDID* → *Create*.
2. Press **ENTER** to open the EDID creation menu.

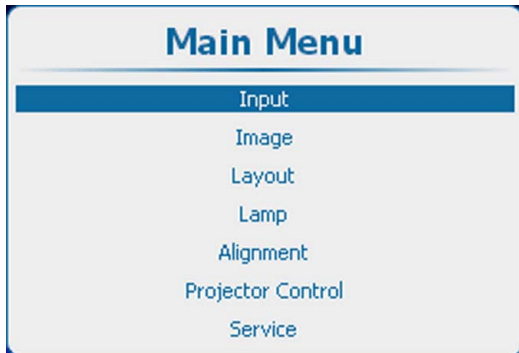


Image 8-44  
Main window

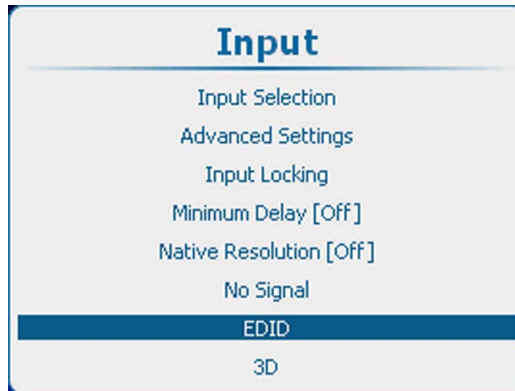


Image 8-45  
Input, EDID



Image 8-46  
EDID, create

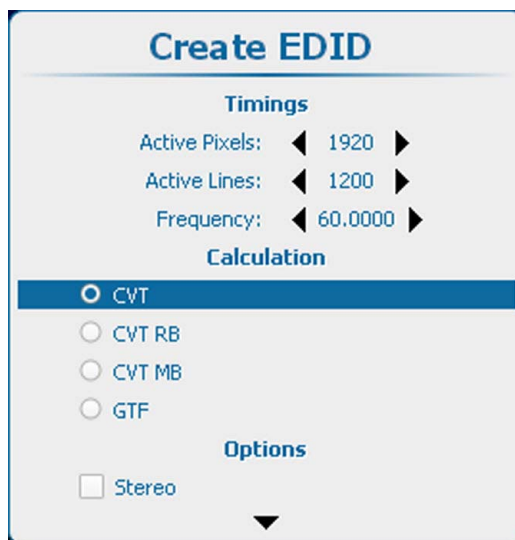


Image 8-47  
EDID file creation

3. Use the **▲** or **▼** key to select *Create*. Press **ENTER** to open the creation menu.
4. Fill out the *Timings* section. Use the **▲** or **▼** key to select a setting. Use the **◀** or **▶** key to change the value or press **ENTER** to open the specific adjustment menu. Follow the adjustment method as described in "Navigation and adjustments", page 68. The following timings must be entered:
  - *Active Pixels*: horizontal resolution
  - *Active Lines*: vertical resolution
  - *Frequency* (Hz): amount of frames per second
5. Select the calculation method to obtain the correct (standard) video timings. Possible selections:
  - *CVT*: Coordinated Video Timings
  - *CVT RB*: Coordinated Video Timings Reduced Blanking
  - *CVT MB*: Coordinated Video Timings Minimum Blanking (not a standard)
  - *GTF*: Generalized Timing Formula

- Select the *Options*.  
If necessary, scroll down to see extra options.  
Select or clear the check boxes.

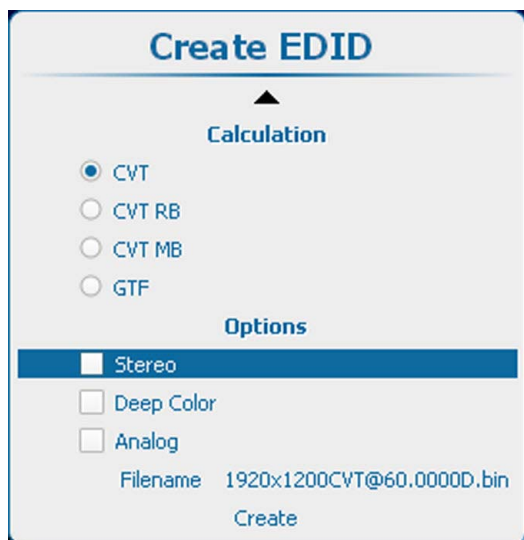


Image 8-48  
EDID file creation, options

The following options are possible:

- *Stereo*: this check box is currently not in use. You can leave it unchecked.
  - *Deep color*: select this box in case of a 12 bit color signal. In this case, the Single Link pins of the DVI connector convey the eight most significant bits, while the Dual Link pins convey the four least significant bits.
  - *Analog*: this check box makes the selection between DVI digital or DVI analog. When checked, DVI analog is active.
- A filename is proposed. This proposed name contains the resolution, calculation, frequency and a D or A for digital or analog. To change the file name, select *Filename* and press **ENTER** to open the edit box. Click inside the edit box and change the name to the desired name.
  - Select *Create* and press **ENTER** to create the new custom file.

### 8.8.3 Delete a custom EDID file



Standard EDID files cannot be deleted.

#### How to delete

- Press **Menu** to activate the menus and select *Input* → *EDID* → *Delete*.
- Press **ENTER** to open the EDID list with custom files.

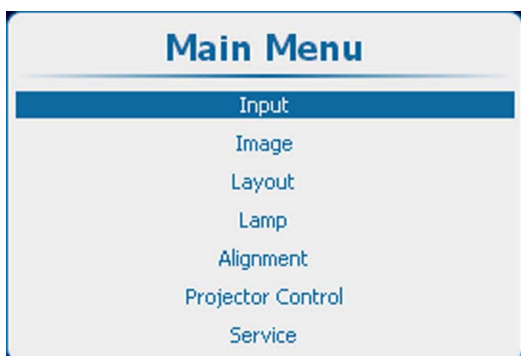


Image 8-49  
Main window

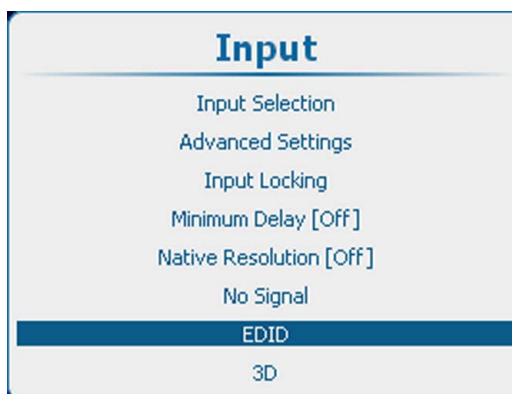


Image 8-50  
Input, EDID



Image 8-51  
EDID, delete

3. Use the ▲ or ▼ key to select the file which must be deleted.  
Press **ENTER** to delete.

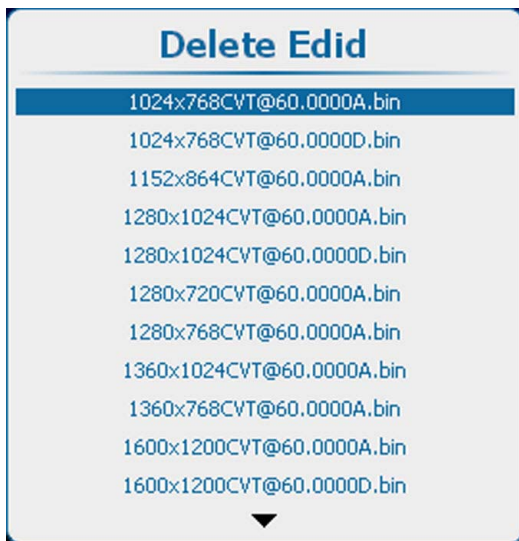


Image 8-52  
EDID, delete list



Image 8-53  
Confirmation

A confirmation window opens.

4. Select Yes to delete the file and press **ENTER**.

#### 8.8.4 Delete all custom EDID file



**Standard EDID files cannot be deleted.**

---

#### How to delete

1. Press **Menu** to activate the menus and select *Input* → *EDID* → *Delete All*.
2. Press **ENTER** to open the confirmation window.

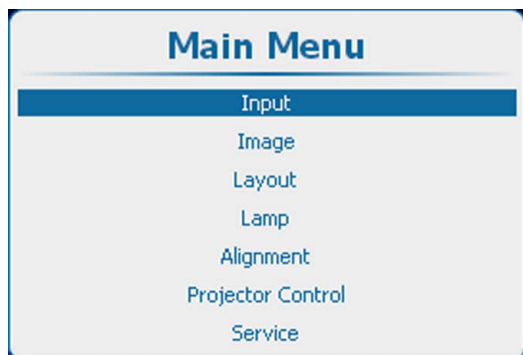
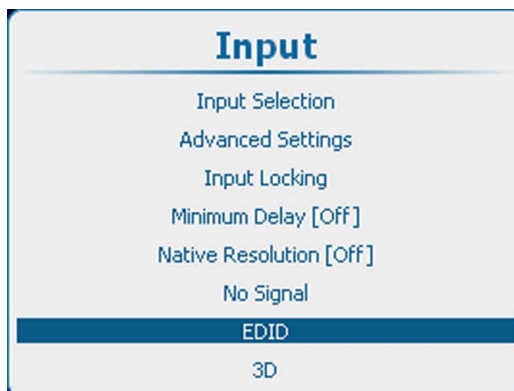
Image 8-54  
Main windowImage 8-55  
Input, EDID

Image 8-56

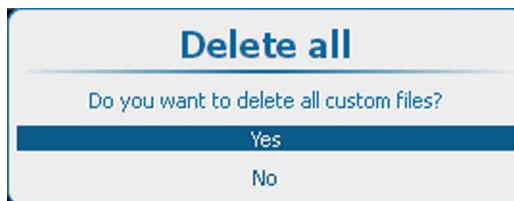


Image 8-57

3. Select Yes to delete all the custom file and press **ENTER**.

## 8.9 3D input

### Overview

- About 3D modes
- Activate 3D
- Auto detection
- Input type selection
- 3D second input
- L-R Synchronisation, field dominance
- L-R Synchronisation, Invert 3D sync out

### 8.9.1 About 3D modes



The mentioned menu items in the mode explanation will be explained in detail in the next topics.

Settings in the 3D menu are stored per input.

#### Single 3D channel - Full resolution - sequential mode

Content is displayed by one 3D source. The frames for the left eye and right eye are displayed alternately (sequential mode). Optional an external 3D sync can be used. The external 3D sync has to be applied to the "3D SYNC IN" port (BNC socket at the left) of the 3D Input Module.

If two 3D Input Modules are used:

- In case a 3D Input Module is selected: use the SYNC IN of this 3D Input Module.
- In case another (DVI, SDI, 5-cable, ...) input module is selected: use the SYNC IN of the first (lowest input number) 3D Input Module.

If the external 3D sync is not available an internal 3D sync is generated by the projector. With the setting "**Field dominance**" the Sync In signal can be inverted to match the left and right eye fields.

**MENU** > *Input* > *3D* > *L/R Synchronisation* > *Field Dominance [L/R] or [R/L]*

Example: A DisplayPort source with a frequency of 120 Hz consisting of content for the left and right eye results in a 60 Hz video per eye.

To activate the single channel 3D mode select:

**MENU > Input > 3D > Frame Sequential – Single Channel**

Possible sources: DisplayPort, HDMI, dual-link DVI, 5-cable analog (up to 210 MHz), DVI analog (up to 170 MHz), SDI (up to 150 MHz).



**With the “Invert 3D sync out” setting the content can be switched between the left and right eye of the user.**

**The “Field dominance” setting has only effect in the 3D mode: Frame sequential → Single channel (in all other modes this setting is grayed out). Furthermore, the input frequency must be equal or lower than 100 Hz (50 Hz per eye). In case the input frequency is higher than 100 Hz (50 Hz per eye, 59.94 & 60 Hz in practice), the “Field dominance” setting has no effect.**

### Single 3D channel - Full resolution - other formats

Contains Frame packing and Line Alternating (3G-B).

To activate the single channel 3D mode select:

**MENU > Input > 3D > Frame packing (FHD3D)**

or

**MENU > Input > 3D > Line Alternating (3G-B)** (only for SDI input)

### Single 3D channel - Half resolution

3D content is distributed by one 3D source by means of “Side By Side”, “Top Bottom” or “SENSIO® Hi-Fi 3D”..

To activate this single channel 3D mode select one of the three options:

**MENU > Input > 3D > Side-By-Side (Half)**

**MENU > Input > 3D > Top-and-Bottom (Half)**

**MENU > Input > 3D > SENSIO® 3D Decoder - FFC** (only on 3D input)

Example: A 3D HDMI source with a Side by Side video of 60 Hz results in a 60 Hz video per eye.

In this mode the 3D Input Module also generates the 3D sync.

Possible sources: Display Port, HDMI, DVI , SDI input.

### Dual 3D channel - Two parallel 3D content streams

3D content is applied to the projector via two input ports. One port is used for content of the left eye, the other port for the right eye.

Example: Two parallel DVI streams of 60 Hz: DVI cable 1 is connected with the DVI port of the projector. DVI cable 2 is connected via a HDMI converter cable with the HDMI port of the 3D Input Module. To switch the HDMI/DP input to HDMI, select

**MENU > Input > Advanced Settings > HDMI/DP > HDMI.**

For the second source the correct type has to be selected as follows with the first source already selected :

**MENU > Input > 3D > Second Input > “select corresponding slot number”**

The 3D Input Module is activated for Dual 3D channel:

**MENU > Input > 3D > Frame Sequential – Dual channel**

Possible sources: 2 x DVI , 2 x SDI. If two 3D Input Modules are installed: 2 x HDMI or 2 x DisplayPort.

### SENSIO® Hi-Fi 3D

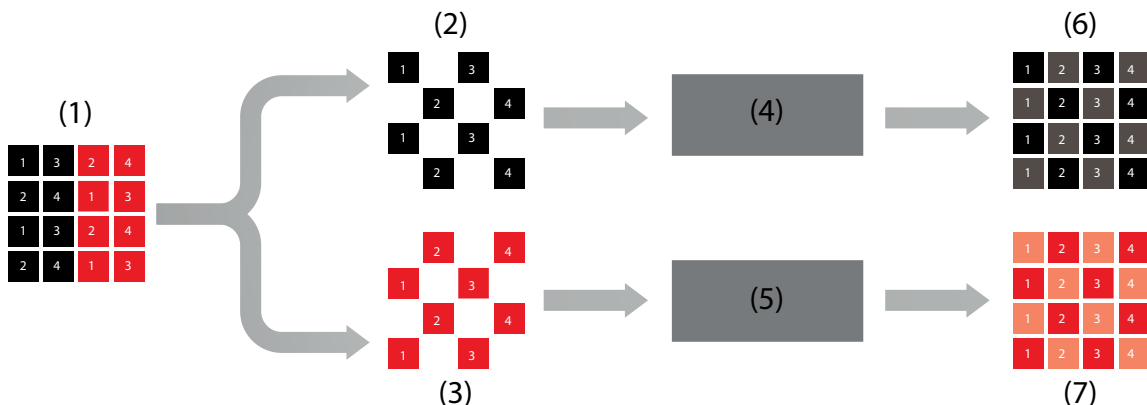


Image 8-58  
SENSIO® Hi-Fi 3D decoding

- 1 SENSIO® Hi-Fi 3D stream
- 2 Left expansion
- 3 Right expansion
- 4 SENSIO® Hi-Fi 3D interpolation
- 5 SENSIO® Hi-Fi 3D interpolation
- 6 Right stream
- 7 Left stream

SENSIO® 3D Decoder - FFC is using both the SENSIO® 3D Decoder as well as the SENSIO® Autodetect functionality. This mode enables an automatic detection of 2D, Top-and-Bottom, Side-by-Side and the SENSIO® Hi-Fi 3D format, with a clean transition and fast detection time between these formats. Only progressive formats are supported. Interlaced formats will be displayed in 2D (one eye only). The SENSIO® Autodetect feature requires a minimum of 1120x540 active pixels per field/frame to operate.

The acronym FFC stands for 'Full Frame Compatible', in other words, the decoder handles all full frame based 3D formats.

### Double or triple flash

Double or triple flash is used for 3D sources to avoid flickering images.

Input frequency < 40Hz/eye → triple flash will be used and results in:

- 144Hz for 24Hz/eye input
- 150Hz for 25Hz/eye input
- 180Hz for 30Hz/eye input

Input frequency between 40Hz and 51Hz/eye → double flash will be used and results in:

- 192Hz for 48Hz/eye input
- 200Hz for 50Hz/eye input

### Supported formats

	DVI/HDMI/DP	5-cable analog	DVI analog	SDI
	Fpix ≤ 210 MHz	Fpix ≤ 210 MHz	Fpix ≤ 170 MHz	Fpix ≤ 150 MHz
Frame sequential Single channel	Max. resolution: 1920x1200@60Hz or 2048x1080@60Hz.  1400x1050@120Hz or 1600x900@120Hz.	Max. resolution: 1920x1200@60Hz or 2048x1080@60Hz.  1400x1050@120Hz or 1600x900@120Hz.	Max. resolution: 1920x1200@60Hz or 2048x1080@60Hz.  1280x720@120Hz or 1280x800@120Hz.	Max. resolution: 1920x1200@60Hz, 2048x1080@60Hz or 1280x720@120Hz.
	Interlaced/progressive	Interlaced/progressive	Interlaced/progressive	Interlaced/progressive
Frame Packing (FHD3D)	HD formats only.  Max. resolution: 1920x1080@30Hz or 1280x720@60Hz.	HD formats only.  Max. resolution: 1920x1080@30Hz or 1280x720@60Hz.	HD formats only.  Max. resolution: 1920x1080@30Hz or 1280x720@60Hz.	HD formats only.  Max. resolution: 1920x1080@30Hz or 1280x720@60Hz.
	Progressive only	Progressive only	Progressive only	Progressive only
Side-by-Side	Max. resolution: 1920x1200@60Hz or 2048x1080@60Hz.	Max. resolution: 1920x1200@60Hz or 2048x1080@60Hz.	Max. resolution: 1920x1200@60Hz or 2048x1080@60Hz.	Max. resolution: 1920x1200@60Hz or 2048x1080@60Hz.
	Interlaced/progressive	Interlaced/progressive	Interlaced/progressive	Interlaced/progressive
Top-and-Bottom	Max. resolution: 1920x1200@60Hz or 2048x1080@60Hz.	Max. resolution: 1920x1200@60Hz or 2048x1080@60Hz.	Max. resolution: 1920x1200@60Hz or 2048x1080@60Hz.	Max. resolution: 1920x1200@60Hz or 2048x1080@60Hz.
	Progressive only	Progressive only	Progressive only	Progressive only

## 8. Input

	2xDVI/2xHDMI/2xDP <sup>1</sup>	2xSDI <sup>2</sup>
Frame Sequential	Fpix ≤ 210MHz.	Fpix ≤ 150MHz.
Dual Channel	Max. resolution: 1920x1200@60Hz or 2048x1080@60Hz.	Max. resolution: 1920x1200@30Hz, 2048x1080@30Hz or 1280x720@60Hz.
	Progressive only	Progressive only
SDI (3G - Level B) <sup>3</sup>		
Line Alternating (3G-B)	Fpix ≤ 150MHz.	
	Max. resolution 1920x1200@30Hz, 2048x1080@30Hz or 1280x720@60Hz.	
HDMI/DP		
SENSIO® 3D Decoder - FFC	Fpix ≤ 162MHz & Vfreq ≤ 60Hz.	
	Max. resolution: 1920x1200@60Hz or 2048x1080@60Hz.	
	Progressive only	

### Other settings to use the 3D glasses

Adjust the following setting:

- Dark time
- L/R output reference delay
- 3D Sync Loop Through

These settings can be found as follows:

**MENU** > *Alignment* > *3D Glasses*

### 8.9.2 Activate 3D

#### What can be done ?

The status of the 3D function can be enabled or disabled.

This function is input dependent.

#### How to enable/disable

1. Press **Menu** to activate the menus and select *Input* → *3D* → *Status*.

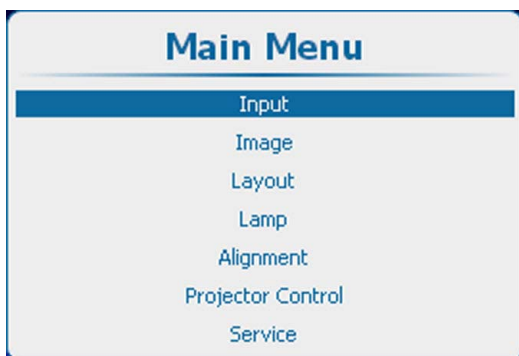


Image 8-59  
Main window

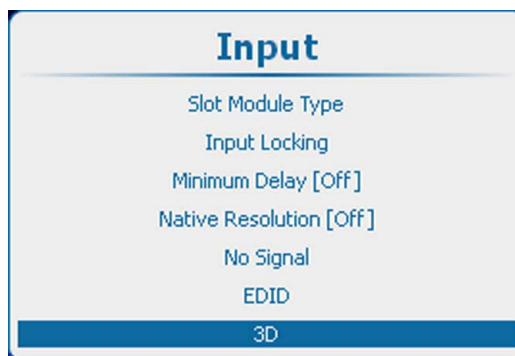


Image 8-60  
Input, 3D

1. 2x HDMI and 2x DP requires 2 3D input modules. 2xDVI can be done with a DVI input and a 3D input with DVI to HDMI convertor  
 2. For 2xSDI, IN1 and IN2 of the SDI input can be used. The input settings under MENU -> Input -> Advanced Settings -> SDI/HDSDI/3G must be set to 'DUAL SDI'  
 3. For SDI (3G- Level B), IN1 or IN2 of the SDI input can be used. The input settings under MENU -> Input -> Advanced Settings -> SDI/HDSDI/3G must be set to 'Input 1' or 'Input 2', with or without Priority



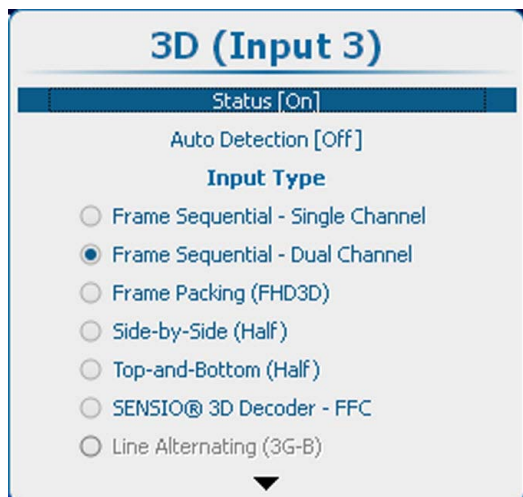


Image 8-61  
3D status

2. Press **ENTER** to toggle between *[On]* and *[Off]*.

[On] : 3D activated

[Off] : 3D deactivated

### 8.9.3 Auto detection

#### About auto detection

- Automatically detects the 3D format (Frame Packing, Side-by-Side, Top-and-Bottom) on HDMI sources, based on the content of the HDMI Vendor Specific InfoFrame (if present). For a detailed explanation of the HDMI vendor specific InfoFrame, refer to the HDMI 1.4a specification.
- Will select SENSIO® 3D Decoder – FFC in case Side-by-Side or Top-and-Bottom mode is detected or if no InfoFrame data is present.
- Does not support Frame Sequential modes (Single and Dual Channel).
- Is not available on other inputs (only on the inputs of the 3D input module) and will be grayed out.

Based on data in the InfoFrame and received feedback from the SENSIO® Autodetect core, the following formats (Input Type) will be selected:

3D format in InfoFrame	SENSIO® Autodetect feedback	Input type selected
Frame Packing	NA <sup>4</sup>	Frame Packing (FHD3D)
Side-by-Side	Side-by-Side or SENSIO® Hi-Fi 3D	SENSIO® 3D Decoder – FFC
	Other	Side-by-Side (Half)
Top-and-Bottom	Top-and-Bottom	SENSIO® 3D Decoder – FFC
	Other	Top-and-Bottom (Half)
No InfoFrame data present	NA <sup>4</sup>	SENSIO® 3D Decoder – FFC

#### How to activate/deactivate

1. Press **Menu** to activate the menus and select *Input* → *3D* → *Auto detection*.

4. NA:feedback from SENSIO® Autodetect is not applicable in these cases

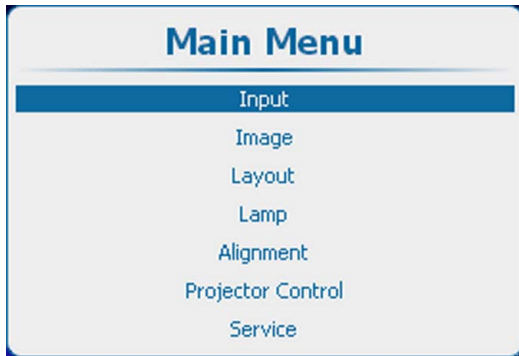


Image 8-62  
Main window

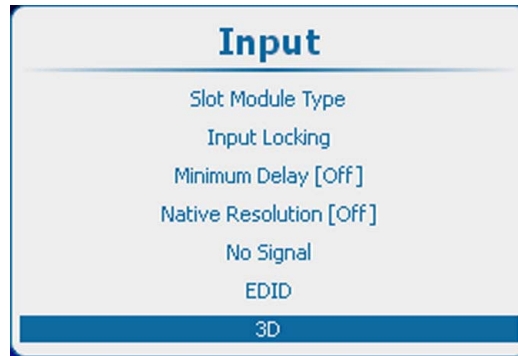


Image 8-63  
Input, 3D

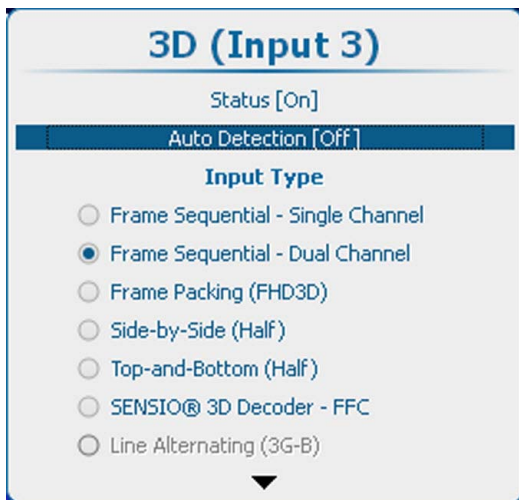


Image 8-64  
3D, auto detection

### 8.9.4 Input type selection

#### About input types

- Frame sequential - Single channel : One input contains 3D information, alternating the left and the right information.
- Frame sequential - Dual channel : Two inputs, one contains the left eye information and the other contains the right eye information
- Frame packing (FHD 3D) : One input contains 3D information, packed in one frame.
- Side-by-Side (Half) : One input contains 3D information with half of the resolution.
- Top-and-Bottom (Half): One input contains 3D information with half of the resolution.
- SENSIO® 3D Decoder - FFC: HDMI/DisplayPort (only on 3D input module).
- Line Alternating (3G-B): SDI only

#### How to select

1. Press **Menu** to activate the menus and select *Input* → *3D*

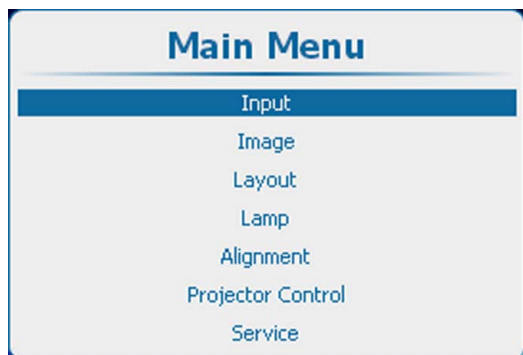


Image 8-65  
Main window

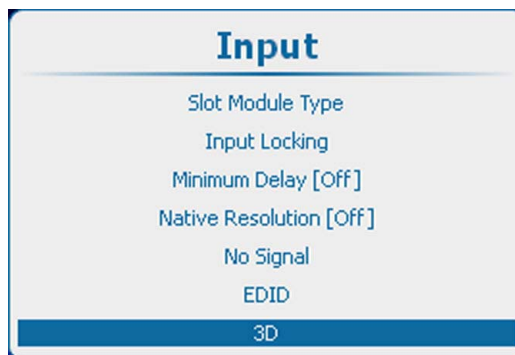


Image 8-66  
Input, 3D

2. Press **ENTER** to open the 3D menu
3. Use the **▲** or **▼** key to select the desired input type.

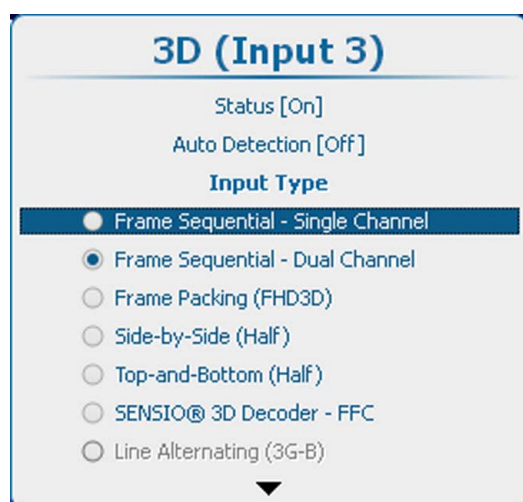


Image 8-67  
3D, input type

4. Press **ENTER** to activate.

### 8.9.5 3D second input

#### What can be done?

3D content can be entered into the projector via a single channel (one input) or via 2 channels (2 inputs). When entering content via 2 channels, the second source must be indicated in the 3D menu.

This selection is only possible when a 2 channel 3D input is chosen.

#### How to make selection

1. Press **Menu** to activate the menus and select *Input* → *3D* → *Second input*.



Image 8-68  
Main window

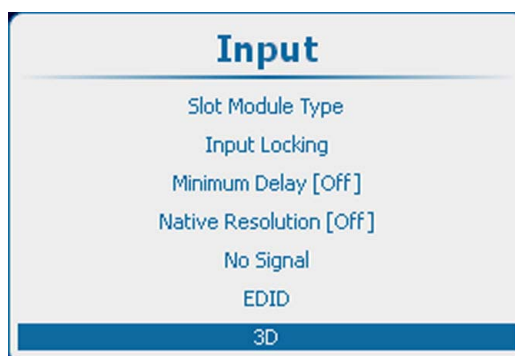


Image 8-69  
Input, 3D

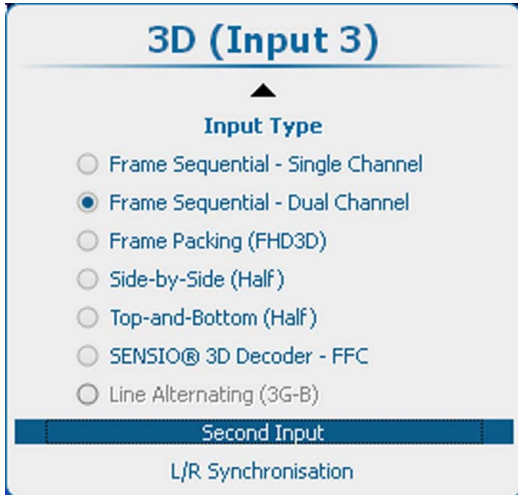


Image 8-70  
3D second source

2. Press **ENTER** to select.  
The *Source selection* window opens.
3. Use the **▲** or **▼** key to select the desired input and press **ENTER**.

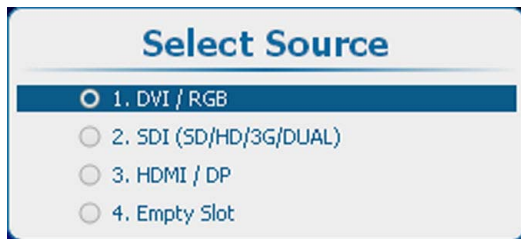


Image 8-71  
Second source, select input

### 8.9.6 L-R Synchronisation, field dominance

#### About field dominance

The *Field dominance* setting has only effect in the 3D mode: Frame sequential - Single channel (in all other modes this setting is grayed out). Furthermore, the input frequency must be equal or lower than 100 Hz (50 Hz per eye). In case the input frequency is higher than 100 Hz (50 Hz per eye, 59.94 & 60 Hz in practice), the “Field dominance” setting has no effect.

For the lower input frequencies (40 Hz or lower/eye), triple flash is used and for frequencies between 40 and 51 Hz/eye double flashing is introduced and the coupling between the video input signal and the 3D SYNC IN signal must be determined.

This setting is stored per input.

#### How to activate

1. Press **Menu** to activate the menus and select *Alignment* → *3D Glasses* → *L/R Synchronisation*.

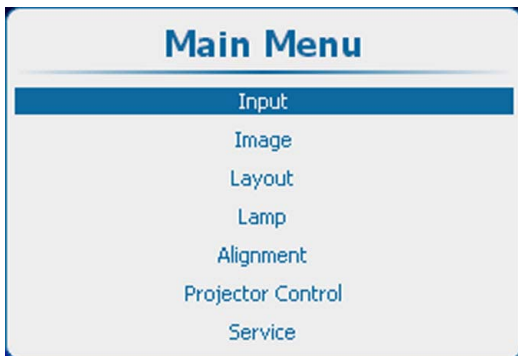


Image 8-72  
Main window

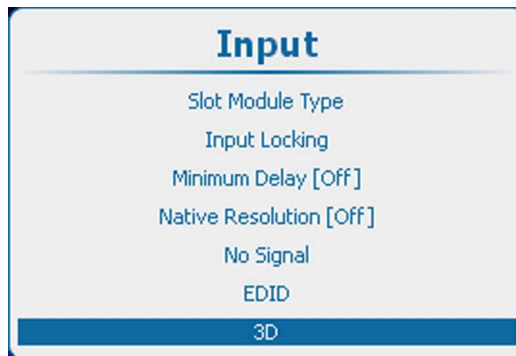


Image 8-73  
Input, 3D

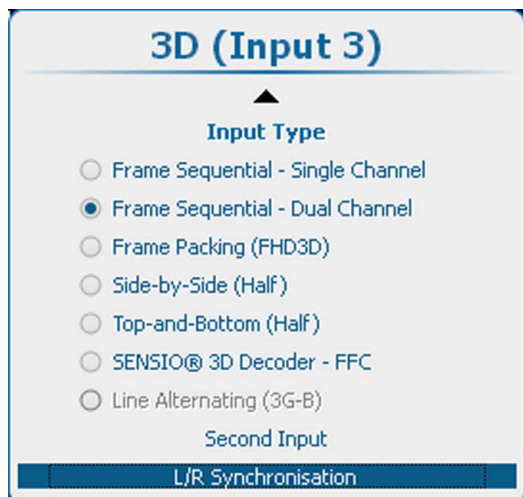


Image 8-74

2. Press **ENTER**.
3. Use the ▲ or ▼ key to select *Field Dominance*.

Image 8-75  
Field dominance

4. Press **ENTER** to toggle between *[L/R]* and *[R/L]*
  - [L/R] : The 3D SYNC IN signal is used to indicate the left and right field sequence.
  - [R/L] : The inverted 3D SYNC IN signal is used to indicate the left and right field sequence.

### 8.9.7 L-R Synchronisation, Invert 3D sync out

#### What can be done?

This menu allows to set the 3D emitter output signal.

With *Invert 3D sync out* we can swap the left and right 3D sync to eliminate a 3D output mismatch with the 3D emitters.

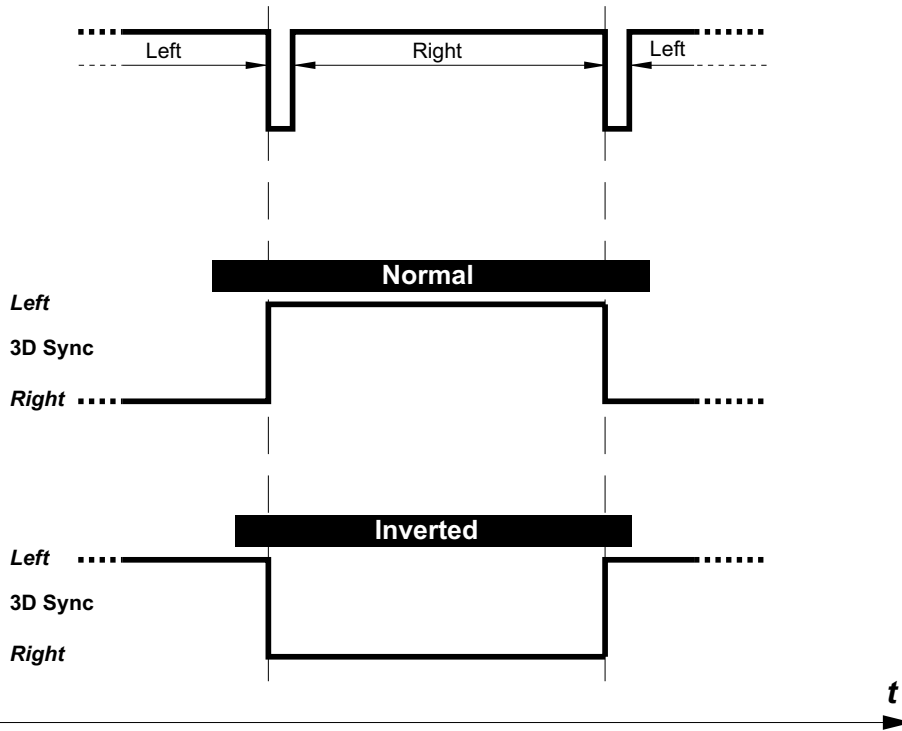


Image 8-76  
3D sync out

### How to toggle 3D SYNC OUT

1. Press **Menu** to activate the menus and select *Alignment* → *3D Glasses* → *L/R Synchronisation*.

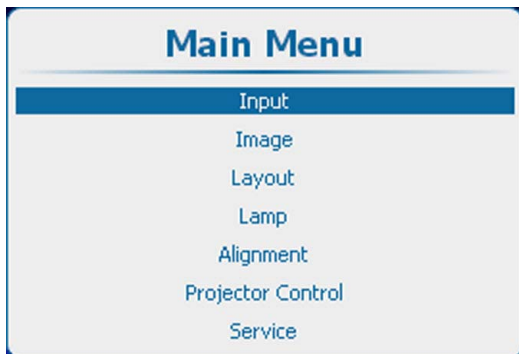


Image 8-77  
Main window

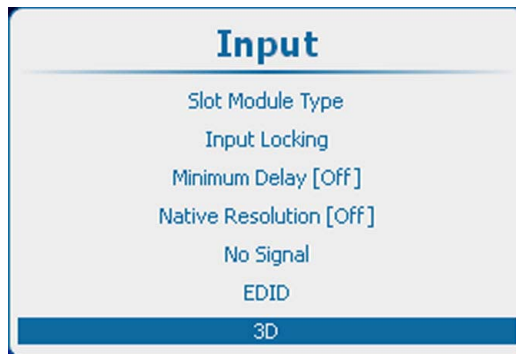


Image 8-78  
Input, 3D

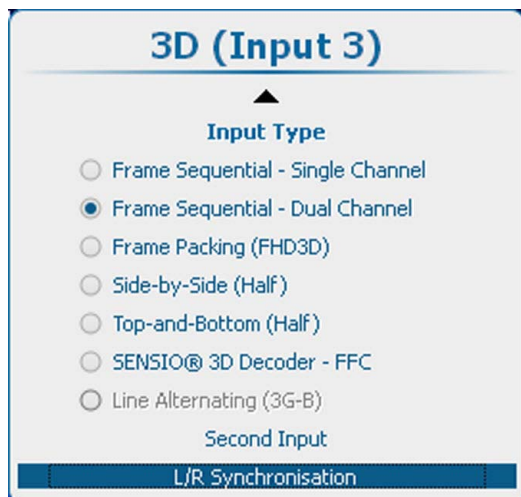


Image 8-79  
3D, L/R Synchronisation

2. Press **ENTER**.
3. Use the ▲ or ▼ key to select *Invert 3D Sync Out*.



Image 8-80  
Invert 3D Sync Out

4. Press **ENTER** to toggle between *[On]* and *[Off]*

[On] : 3D SYNC OUT is the inverted version of the 3D sync signal generated by the processing, allowing to swap left and right eye on the active glasses.

[Off] : 3D SYNC OUT is a copy from the 3D sync signal generated by the processing.





## 9. IMAGE

### Overview

- Image menu overview
- Start up the Image adjustments
- Image settings
- Aspect Ratio
- Timings
- Image File Services
- Save custom settings
- Splash image

### 9.1 Image menu overview

#### Overview table

Level 1	Level 2	Level 3	Level 4
Image			
	Image settings	Contrast	
		Brightness	
		Saturation	
		Tint	
		Phase	
		Sharpness	
		Color Temperature	Projector white
			Computer 9300K
			Video 6500K
			Film 5400K
			Broadcast 3200K
			Custom Balance
		Input Balance	Black Balance
			White Balance
		Defaults	
	Aspect ratio	4:3	
		16:9	
		5:4	
		2.35	
		1.88	
		1.85	
		1.78	
		1.67	
		16:10	
		Custom	
	Timings	Horizontal Total Pixels	
		Active pixels	
		Horizontal start	
		Period	

	Total vertical lines	
	Active lines	
	Vertical start	
	Advanced settings	Clamp delay
		Clamp width
	Press Auto Image for new measurement	
Image file service	Manual load	
	File load filter	
	Delete	
	Delete all	
	Rename	
	Copy	
	Options	
Save custom settings		
Splash image	On or Off	
	Timeout(sec)	

## 9.2 Start up the Image adjustments

### Start up

1. Press **Menu** to activate the menus and select *Image*

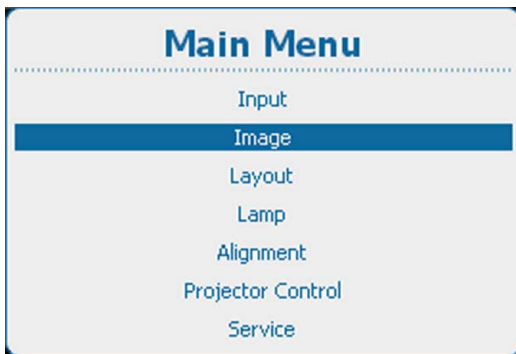


Image 9-1  
Main menu, Image

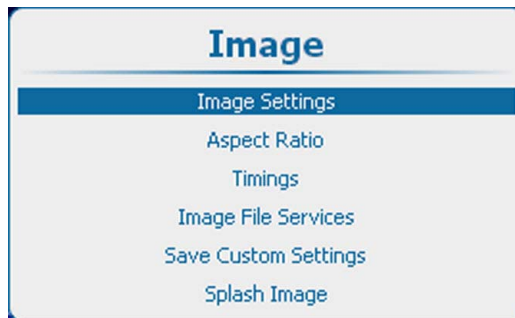


Image 9-2  
Image adjustments

## 9.3 Image settings

### About image settings

Depending on the type of the connected source, some settings are grayed out

Image settings are stored per input.

#### 9.3.1 Contrast

##### About Contrast

The contrast function is used to adjust the contrast between the light and the dark areas of the displayed image. It applies a gain to the red, green and blue signals.

Contrast adjustment can be done with the **Contrast** key on the RCU or via the menu structure.

## How to adjust

1. Press **Menu** to activate the menus and select *Image* → *Image Settings* → *Contrast*.

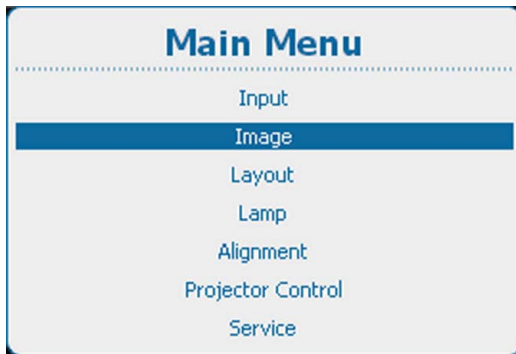


Image 9-3  
Main menu, Image

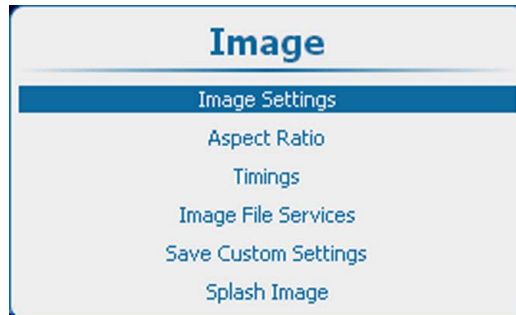


Image 9-4  
Image adjustments

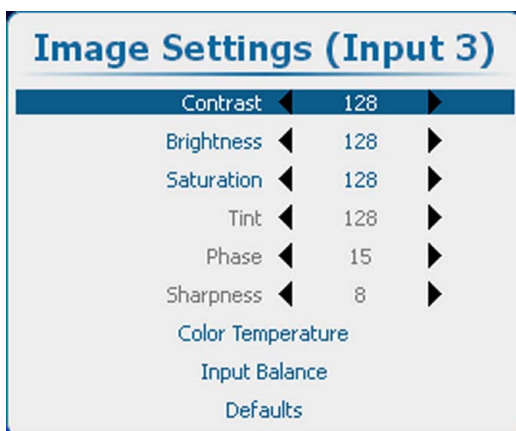


Image 9-5  
Image settings, contrast

2. Press **ENTER** to select.
3. To change the value directly in the Image Settings window, use the ◀ or ▶ key or a numeric key 0-9 to adjust as a % of the full range.  
To adjust via the bar scale menu, press **ENTER** to display the *Contrast* menu and adjust with the ◀ or ▶ key. Press **ENTER** again to enter the value directly with the numeric keys. Press **EXIT** to return to *Image Settings* menu.

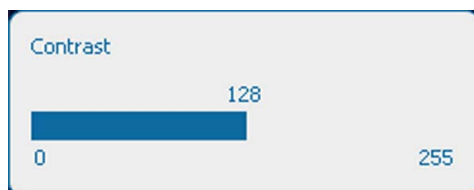


Image 9-6  
Contrast adjustment

### 9.3.2 Brightness

#### About brightness

The brightness function is used to adjust the black level in the input picture. It adds or subtracts an offset, or bias in to the red, green and blue signals.

Brightness adjustment can be done with the **Brightness** key on the RCU or via the menu structure.

#### How to adjust

1. Press **Menu** to activate the menus and select *Image* → *Image Settings* → *Brightness*.

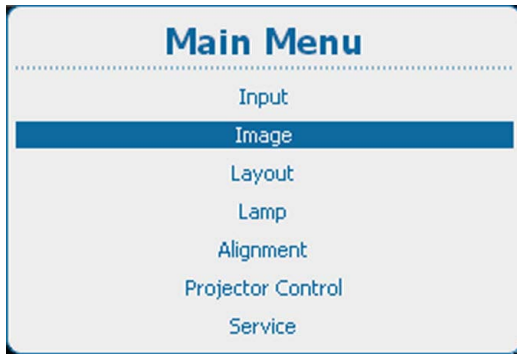


Image 9-7  
Main menu, Image

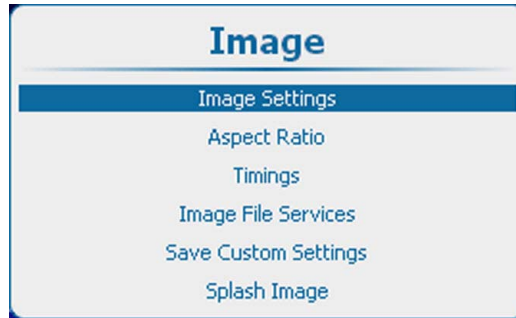


Image 9-8  
Image adjustments

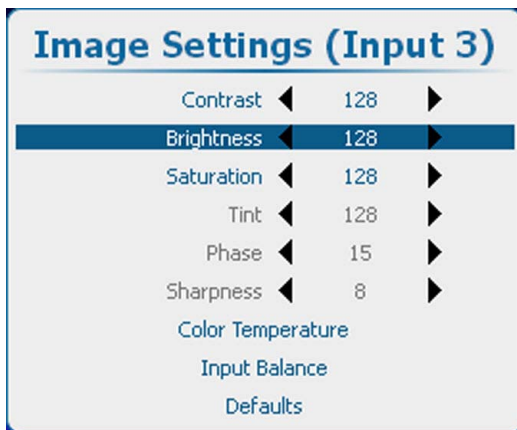


Image 9-9  
Image settings, brightness

2. Press **ENTER** to select.
3. To change the value directly in the Image Settings window, use the ◀ or ▶ key or a numeric key 0-9, to adjust as a % of the full range.  
To adjust via the bar scale menu, press **ENTER** to display the *Brightness* menu and adjust with the ◀ or ▶ key. Press **ENTER** again to enter the value directly with the numeric keys. Press **EXIT** to return to *Image Settings* menu.

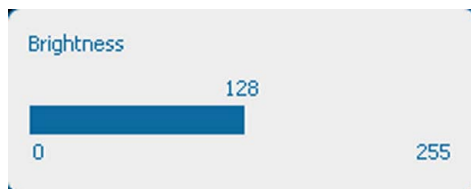


Image 9-10  
Brightness adjustment

### 9.3.3 Saturation

#### About (color) saturation

The saturation function is used to adjust the color saturation levels.

Saturation adjustment can be done with the **Saturation** key on the RCU or via the menu structure.

#### How to adjust

1. Press **Menu** to activate the menus and select *Image* → *Image Settings* → *Saturation*.

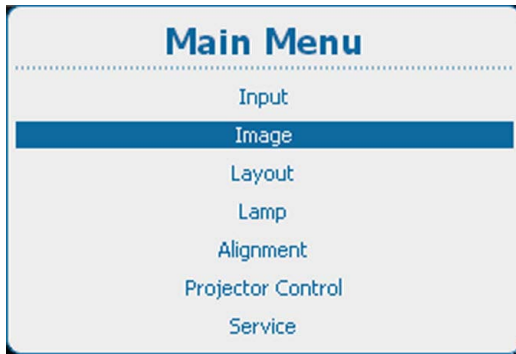


Image 9-11  
Main menu, Image

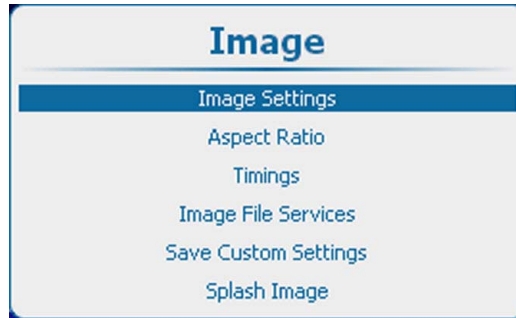


Image 9-12  
Image adjustments

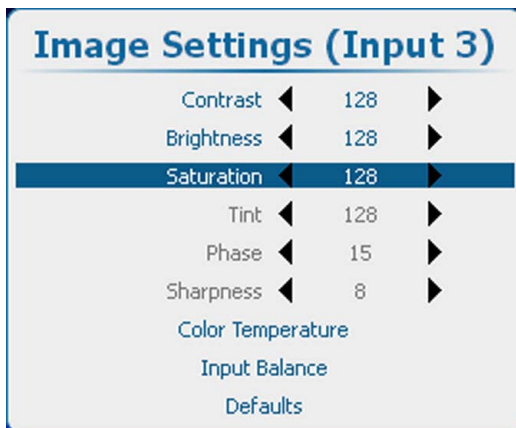


Image 9-13  
Image settings, saturation

2. Press **ENTER** to select.

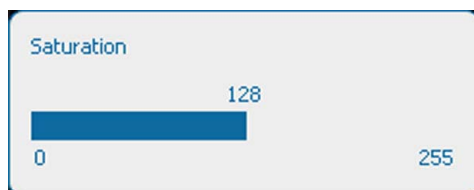


Image 9-14  
Saturation adjustment

3. To change the value directly in the Image Settings window, use the ◀ or ▶ key or a numeric key 0-9, to adjust as a % of the full range.  
To adjust via the bar scale menu, press **ENTER** to display the *Saturation* menu and adjust with the ◀ or ▶ key. Press **ENTER** again to enter the value directly with the numeric keys. Press **EXIT** to return to *Image Settings* menu.

### 9.3.4 Phase

#### About Phase adjustment

When displaying computer patterns or graphics (RGB or YUV signals) which are very detailed (tilting, vertical stripes, etc. ), jitter in picture (mis-sampling) may occur, causing horizontal stripes in portions of the screen. When this jitter occurs, adjust 'Phase' for optimum image.

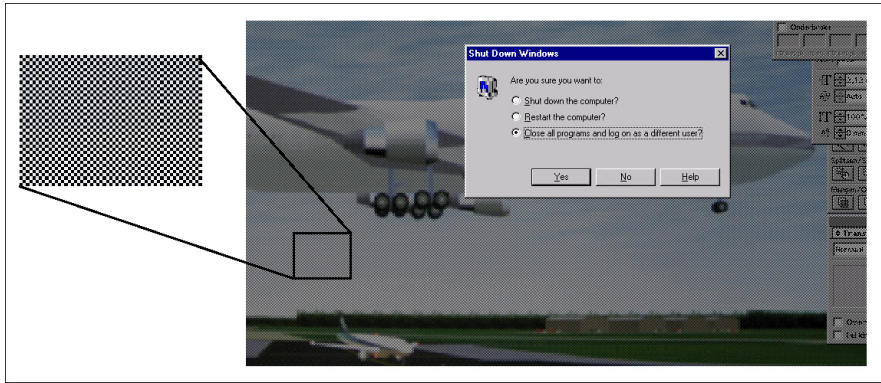


Image 9-15  
Jittering on image

Phase adjustment can be done with the **Phase** key on the RCU or via the menu structure.

### How to adjust

1. Press **Menu** to activate the menus and select *Image* → *Image Settings* → *Phase*.

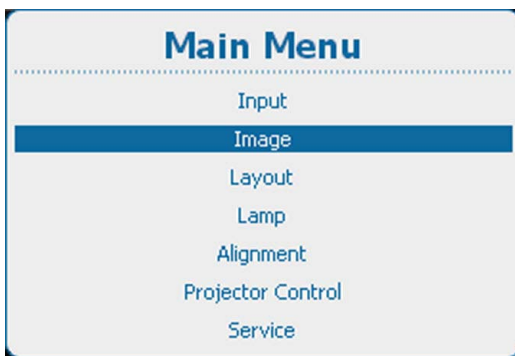


Image 9-16  
Main menu, Image

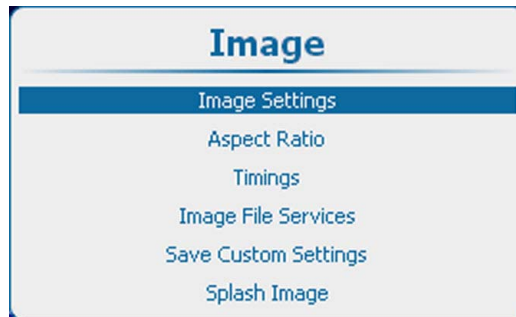


Image 9-17  
Image adjustments

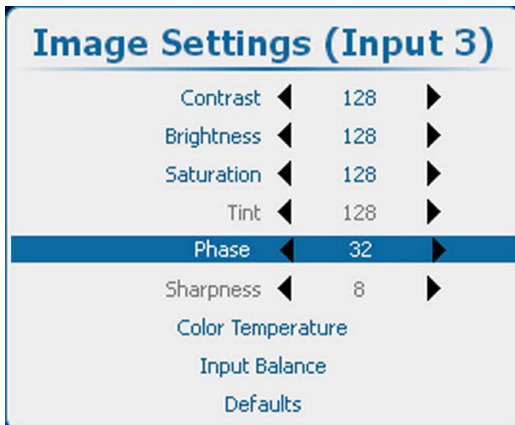


Image 9-18  
Image settings, phase

2. Press **ENTER** to select.



Image 9-19  
Phase adjustment

3. To change the value directly in the Image Settings window, use the **◀** or **▶** key or a numeric key 0-9, to adjust as a % of the full range.

To adjust via the bar scale menu, press **ENTER** to display the *Phase* menu and adjust with the ◀ or ▶ key. Press **ENTER** again to enter the value directly with the numeric keys. Press **EXIT** to return to *Image Settings* menu.

### 9.3.5 Color temperature (fixed values)



#### Color temperature

The coloration (reddish, white, bluish, greenish, etc.) of white in an image, measured using the Kelvin (degrees K) temperature scale. Higher temperatures output more light.



**Projector white will provide maximum projector light output. The calibrated 'Broadcast', 'Film', 'Video' and 'Computer' presets will provide optimum color tracking.**

#### How to select

1. Press **Menu** to activate the menus and select *Image* → *Image Settings* → *Color Temperature*.

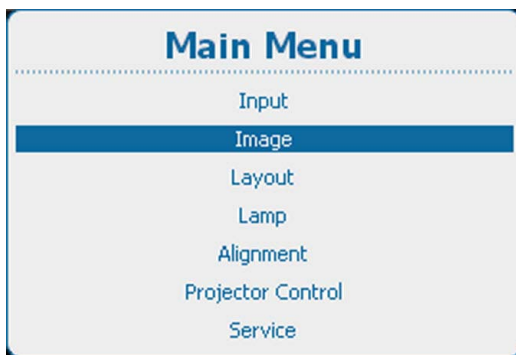


Image 9-20  
Main menu, Image

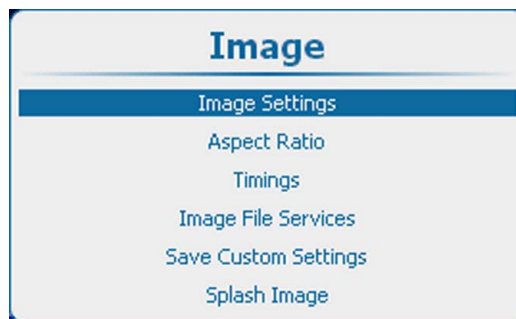


Image 9-21  
Image adjustments

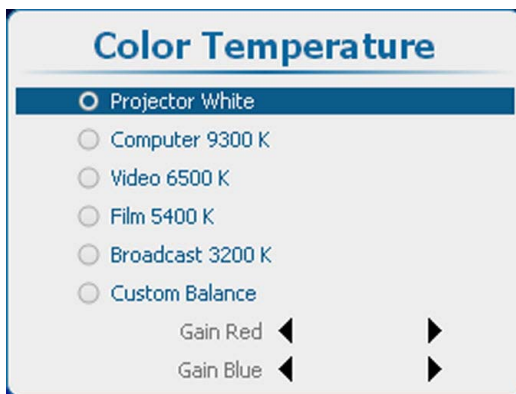


Image 9-22  
Image settings, color temperature

2. Press **ENTER** to select.

The color temperature selection menu is displayed.

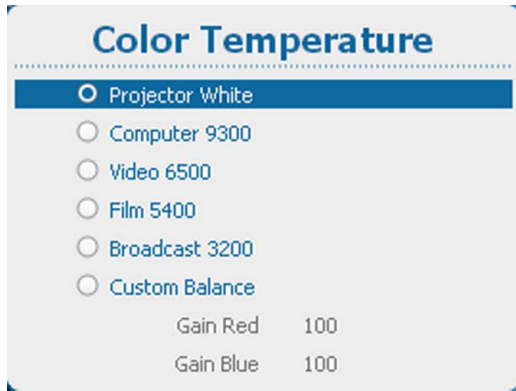


Image 9-23

Depending on the color space setting, a request window is displayed to ask if the color space setting should be switched to Off. Color temperature selection can only be done when the color space settings is set on Off.



Image 9-24  
Color temperature question

Click **Yes** to continue.

- Use the ◀ or ▶ key to select the desired value. Press **ENTER** to accept. The following fixed choices are possible :

- Projector White
- Computer 9300
- Video 6500
- Film 5400
- Broadcast 3200

Next to these 5 fixed temperatures, a custom setup is also possible.

### 9.3.6 Color temperature (custom values)

#### How to set up

- Press **Menu** to activate the menus and select *Image* → *Image Settings* → *Color Temperature*.

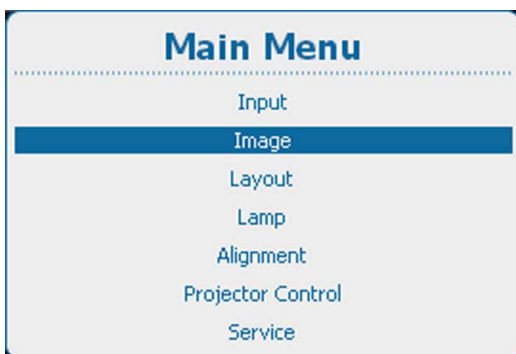


Image 9-25  
Main menu, Image

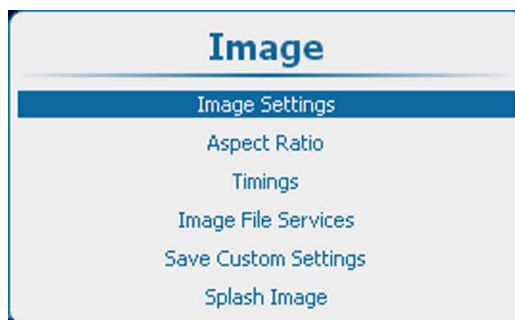


Image 9-26  
Image adjustments



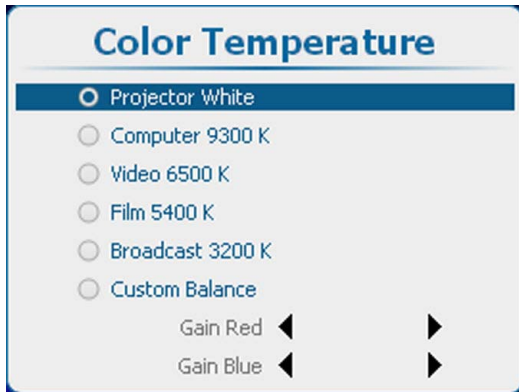


Image 9-27  
Image settings, color temperature

2. Press **ENTER** to select.
3. Use the **▲** or **▼** key to select *Custom Balance*. Press **ENTER** to accept.

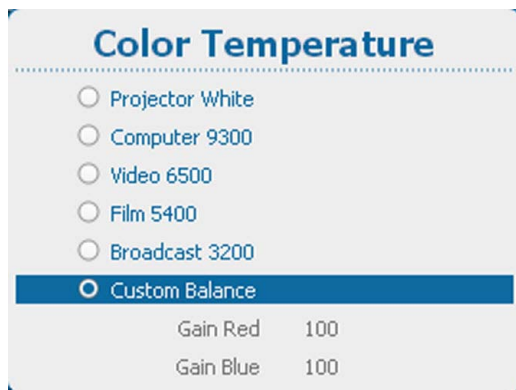


Image 9-28  
Custom color temperature

4. Select Gain Red and press **ENTER**. Use the **◀** or **▶** key to adjust the red gain.  
Select Gain Blue and press **ENTER**. Adjust the blue gain in the same way as the red gain using the **◀** or **▶** key.
5. When finished, press **EXIT** to return.

### 9.3.7 Input Balance

#### 9.3.7.1 Introduction to Input Balance

##### Introduction: Unbalanced color signals

When transporting signals, there is always a risk of deterioration of the information contained in the signals.

In case of information contained in the amplitude of the signals which is the case of data color signals (R, G, B), image 9-29, we are quite sure that the amplitude of these color signals is subject to alterations.

An example of alteration may be a DC component added to the signal, in the form of a DC offset repositioning the black level, since this **black level** (“**brightness**”) will become crucial later on (clamping circuit) it will result in “black not being black”.

Another value that is subject to alteration is the amplitude of the signal, resulting in an altered “Gain” of the signal (“**white level**” or **contrast**).

The alterations of the three color signals will happen independently i.e. the colors will end to be unbalanced, image 9-30

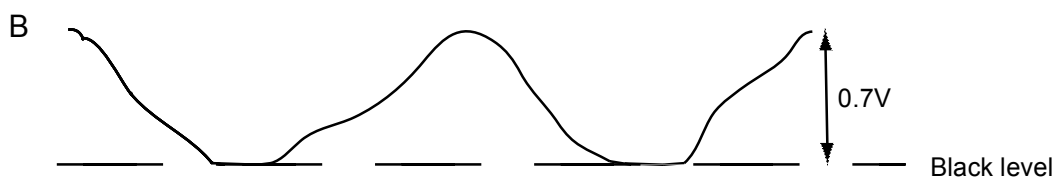


Image 9-29

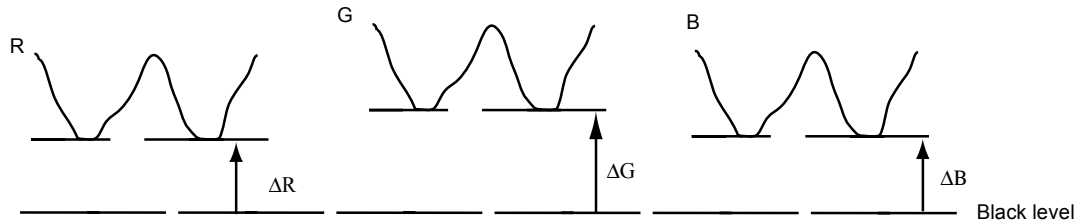


Image 9-30



One can conclude here that a good color tracking can only be met by using three previously (input) balanced color signals

### Analog Digital Conversion

The analog color signals must pass through an Analog/Digital conversion circuit prior to any digital processing in the PMP.

A typical ADC transforms the analog value into an 8 bit coded digital signal.

The graphic shows that when converting a signal containing a DC offset component the range of the converter is not optimally used.

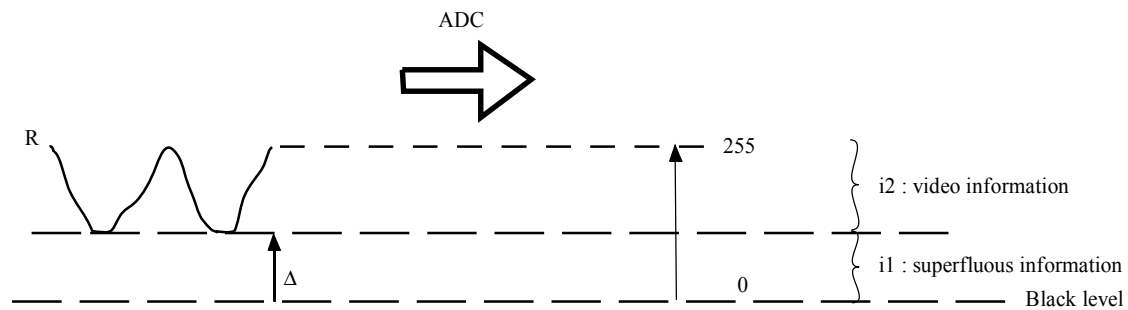


Image 9-31



One can conclude here that a good data conversion can only be met by using three previously (input) balanced color signals

### The objective of input balancing

The objective in input balancing is to "set" the same black level and the same white level for the three colors of a particular input source.



**Black level setting : brightness**

**White level setting : contrast**

The same absolute black and white level for the three colors allows the same reference for Brightness and Contrast control of the picture !

These two references also set the range in which the ADC will work for that particular source (this explains also why each input balance setting is linked to a particular source and thus saved in the image file).

#### 9.3.7.2 Adjusting the input balance

##### How can it be done ?

To balance the three color signals of a particular source there are conditions; in fact we must know the black and the white level of the source i.e. :

1. The source in question must be able to generate a white signal, ideally a 100% white (background) full screen pattern
2. The source in question must be able to generate a black signal, ideally a 100% black (background) full screen pattern

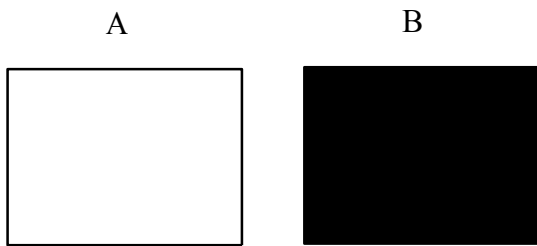


Image 9-32

White balance : In the projector, we will set the contrast for each color until we get a 100% light output picture when projecting a 100% white image (image A)

Black balance : In the projector, we will set the brightness for each color until we get a 0% light output picture when projecting a 100% black image (image B).



The changeover from min to max is indicated by the apparition of bright spots also called “digital noise”



An alternative to a full screen White/black pattern is the standard gray scale pattern, the white bar will be used for white balance and the black bar for black balance.

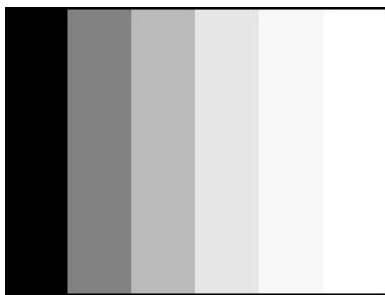


Image 9-33

### How to adjust

1. Press **Menu** to activate the menus and select *Image* → *Image Settings* → *Input Balance*.

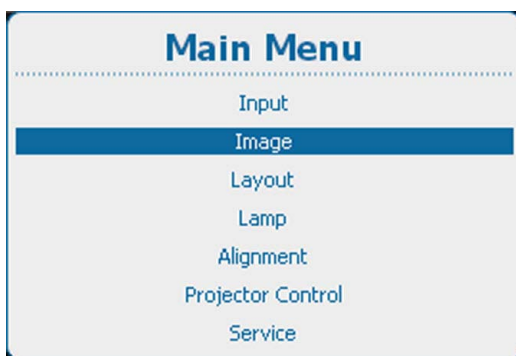


Image 9-34  
Main menu, Image

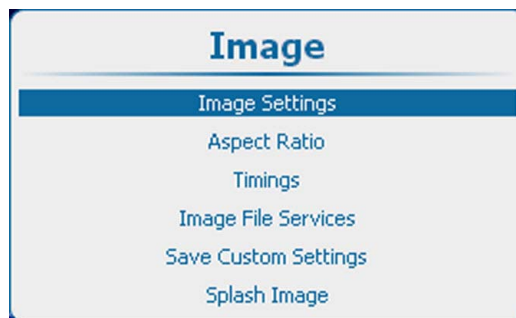


Image 9-35  
Image adjustments

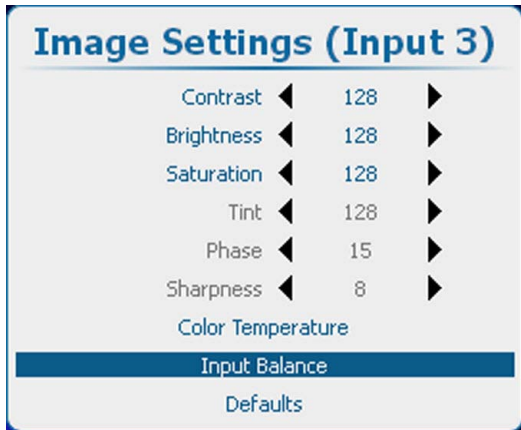


Image 9-36  
Image settings, input balance

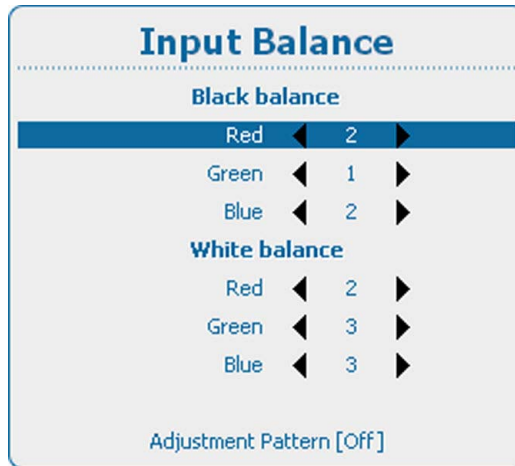


Image 9-37

2. Press **ENTER** to select.
  3. Do you want to use an internally generated test pattern ?  
If yes, use the **▲** or **▼** key to select *Adjustment Pattern* and press **ENTER** to toggle between [on] and [off]  
If no, adjust on the selected source.
  4. Use the **▲** or **▼** key to select *Red* below *Black balance* and press **ENTER**.
  5. Adjust the red black level on a minimal value
  6. Use the **▲** or **▼** key to select *Black balance blue* and adjust the blue black level on a minimal value.  
**Note:** *This minimal value is not necessary, provided that the 2 other colors are not influencing too much the color to be adjusted, in fact the aim is to minimize the effect of the two other colors since there is a risk of reaching too soon the 50% transition due to the contribution of these two other colors signals.*
  7. Use the **▲** or **▼** key to select *Black balance green* and adjust the Green black level until bright spots appear on the screen.
  8. Use the **▲** or **▼** key to select *Black balance blue* and adjust the Blue black level until bright spots appear on the screen.
  9. Use the **▲** or **▼** key to select *Black balance red* and adjust the Red black level until bright spots appear on the screen.
- The projected image should now be noisy full black



**If one uses a gray scale pattern, the bright spots should appear in the black bar.**

### Performing White input balance

1. Connect the source you want to project.
2. Press **Menu** to activate the menus and select *Image* → *Image Settings* → *Input Balance*.

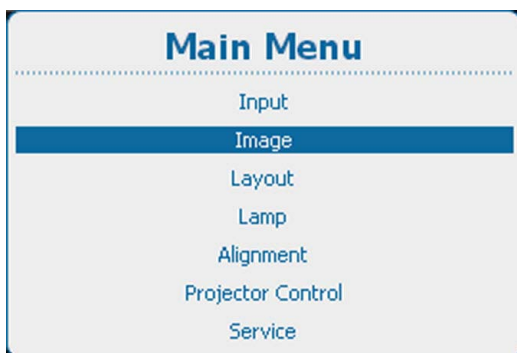


Image 9-38  
Main menu, Image

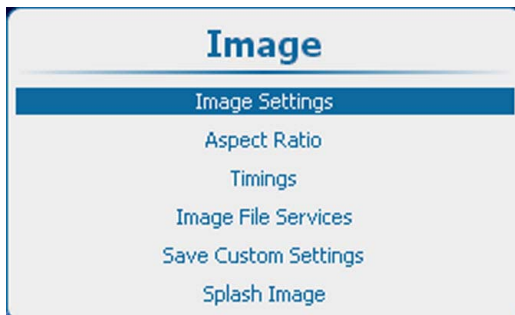


Image 9-39  
Image adjustments

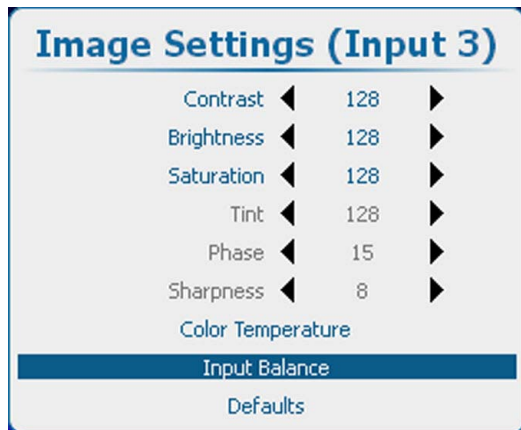


Image 9-40  
Image settings, input balance

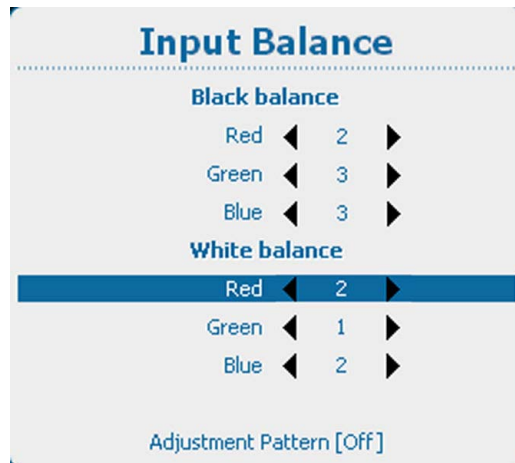


Image 9-41  
Input balance, white balance

3. Press **ENTER** to select.
4. Do you want to use an internally generated test pattern ?  
If yes, use the **▲** or **▼** key to select *Adjustment Pattern* and press **ENTER** to toggle between [on] and [off]  
If no, select a white pattern (or gray scale as alternative).
5. Use the **▲** or **▼** key to select *White balance red*.
6. Adjust the red white level (gain) on a minimal value
7. Use the **▲** or **▼** key to select *White balance blue* and adjust the blue white level (gain) on a minimal value.  
**Note:** *This minimal value is not necessary, provided that the 2 other colors are not influencing too much the color to be adjusted, in fact the aim is to minimize the effect of the two other colors since there is a risk of reaching too soon the transition (bright spots) due to the contribution of these two other colors signals.*
8. Use the **▲** or **▼** key to select *White balance green* and adjust the Green white level (gain) until bright spots appear on the screen.
9. Use the **▲** or **▼** key to select *White balance blue* adjust the Blue white level (gain) until bright spots appear on the screen.
10. Use the **▲** or **▼** key to select *White balance red* adjust the Red white level (gain) until bright spots appear on the screen.

The projected image should now be noisy neutral gray.

### How to adjust for an YUV signal

Use a gray bar test pattern

1. Turn the green black balance back to - 20.
2. Adjust the Red black balance until red dots are visible in the black bar.
3. Adjust the Blue black balance until blue dots are visible in the black bar.
4. Adjust the Green black balance until first gray dots in the black bar (only in the black bar, the rest must be mid gray, except the white bar).
5. If you see multiple or no white bars in stead of one, change white balance for green (higher or lower) until only one bar is visible.

### 9.3.8 Image settings, defaults

#### About the defaults

With the defaults button, all image settings for a specific source are returned to the default values.

#### How to return to the defaults

1. Press **Menu** to activate the menus and select *Image* → *Image Settings* → *Defaults*.

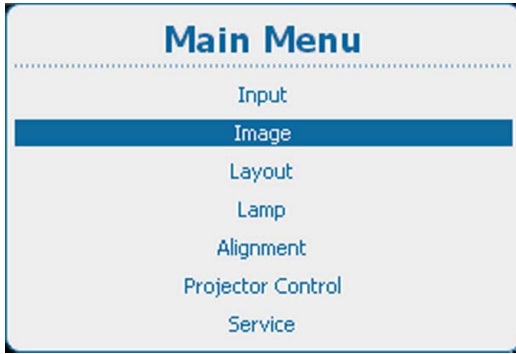


Image 9-42  
Main menu, Image

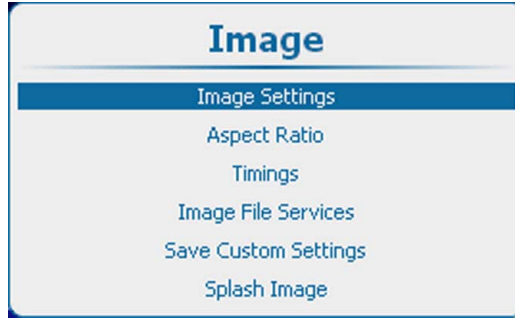


Image 9-43  
Image adjustments

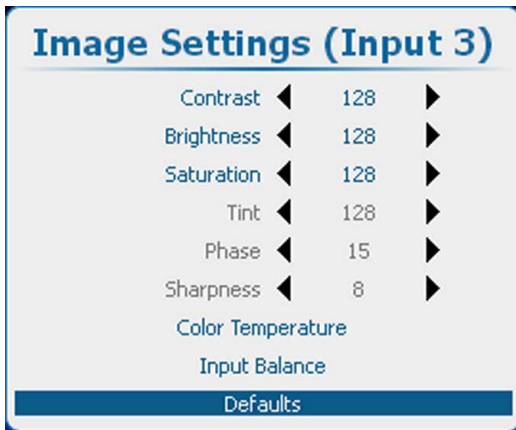


Image 9-44  
Image settings, defaults

2. Press **ENTER** to select.  
A confirmation menu is displayed



Image 9-45  
Defaults confirmation

3. Use the **▲** or **▼** key to select Yes and press **Enter** to confirm.  
The default settings will be applied for the selected source.

## 9.4 Aspect Ratio



### Aspect ratio

Relation between the horizontal & vertical dimension in which the window will be displayed, e.g. 4 by 3 or 16 by 9. Can also be expressed as a decimal number, such as 1.77. The larger the ratio or decimal, the wider the image (or the less the image is squared).

### What can be done?

The aspect ratio setting forces the projector to project an image using a defined aspect ratio.

Aspect ratio	Description
4:3	Standard television format

Aspect ratio	Description
16:9	Wide screen television format / anamorphic format
5:4	Workstation format
2.35	Film format
1.88	Digital cinema 2K aspect ratio
1.85	35 mm US and UK wide screen standard film format
1.78	Wide screen television format / anamorphic format
1.67	European film ratio (also 1280x768)
16:10	Wide screen cinema format (WUXGA format)
Custom	Any custom format can be set up

Some example images:

4/3 signal



Image 9-46  
Example images aspect ratio

16/9 RGB signal



## How to set

1. Press **Menu** to activate the menus and select *Image* → *Aspect Ratio*.

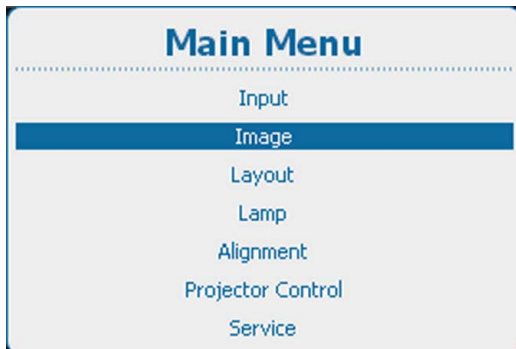


Image 9-47  
Main menu, Image

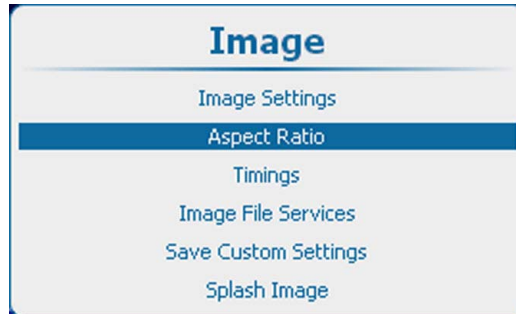


Image 9-48  
Image, aspect ratio

2. Press **ENTER** to select.
3. Use the **▲** or **▼** key to select the desired aspect ratio.

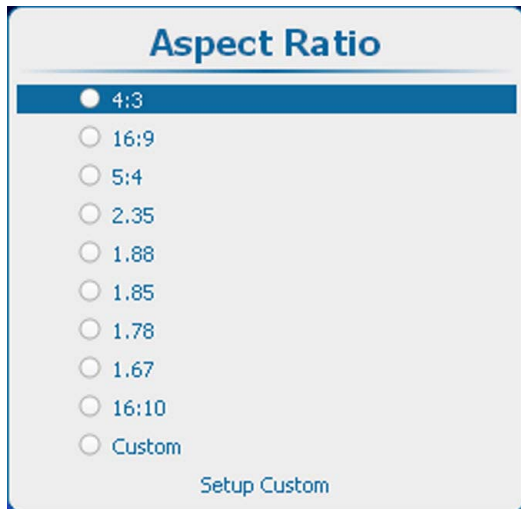


Image 9-49  
Aspect ratio

4. Press **ENTER** to activate.

### How to set up the custom aspect ratio

1. While Custom is selected, use the **▲** or **▼** key to select *Setup Custom* and press **ENTER**.

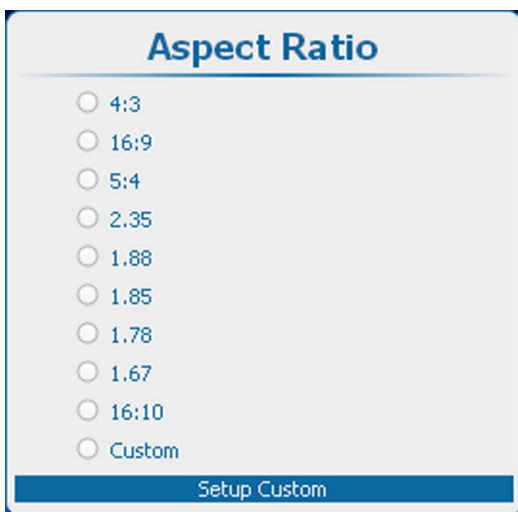


Image 9-50  
Custom aspect ratio

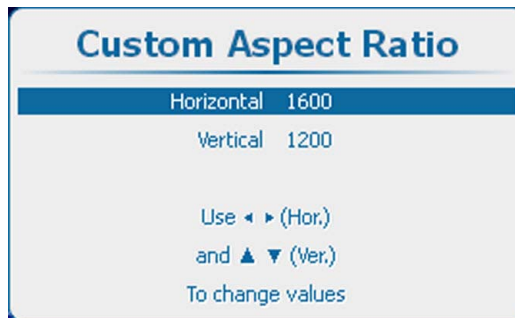


Image 9-51  
Custom aspect ratio adjustment

The custom aspect ratio setup menu opens.

2. Use the **▲** or **▼** key to adjust the vertical size (height) of the image.  
Use the **◀** or **▶** key to adjust the horizontal size (width) of the image.

## 9.5 Timings

### 9.5.1 Source timings

#### Adjustable items

- Horizontal start in pixels : number of pixels between the horizontal sync and active video information in the input signal.
- Horizontal Active = Active horizontal pixels (width) : number of active pixels in the input signal. This value is normally given in the source specifications. If not, adjust until full image is displayed (no missing pixels).
- Vertical start in lines : number of lines between the vertical sync signal and active video information in the input signal.
- Vertical Active = Active vertical lines : number of active lines in the input signal. This value is normally given in the specification of the source. If not, adjust until full image height is displayed (no missing lines).
- Total pixels: Total horizontal pixels in the source. If the value is wrong, sampling mistakes (small vertical bars in the projected image) will be seen in the image.



- Total lines: Total lines in the source.

### How to set up

1. Press **Menu** to activate the menus and select *Image* → *Timings*.

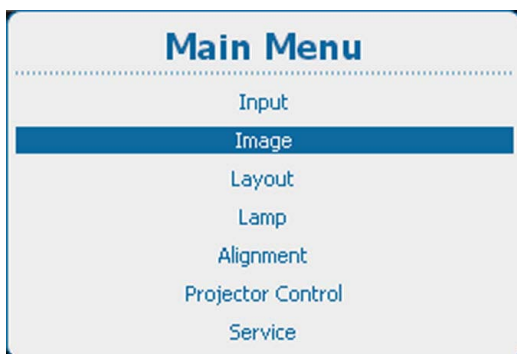


Image 9-52  
Main menu, Image

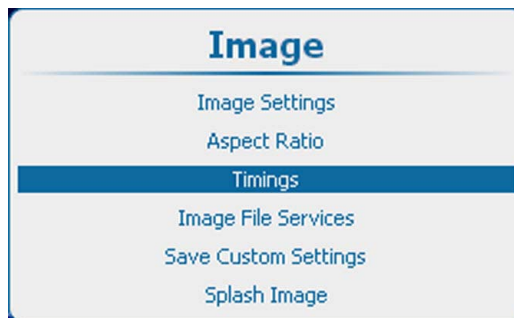


Image 9-53  
Image, timings

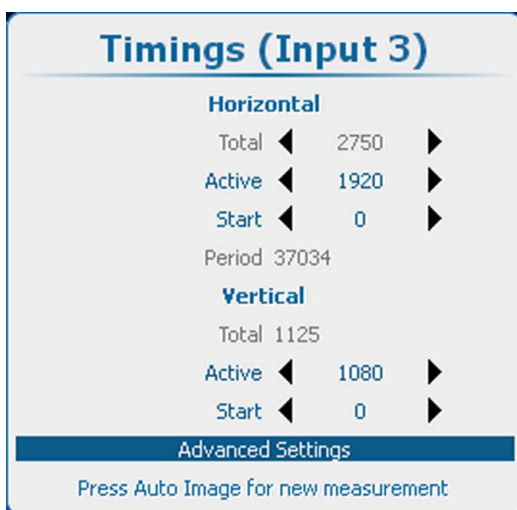


Image 9-54  
Timings window

2. Press **ENTER** to select.
3. Use the **▲** or **▼** key to select a setting.
4. Use the **◀** or **▶** key to change the value  
Or,  
press **ENTER** to open the specific adjustment menu. Follow the adjustment method as described in "Navigation and adjustments", page 68.
5. Continue with the other settings in the same way until all timings are set.



For a new measurement, press the Auto Image button on the RCU or local keypad.

## 9.5.2 Advanced timings, clamp delay - clamp width

### About the advanced settings

- |             |  |
|-------------|--|
| Clamp delay | The time between the trailing edge of the sync pulse and the leading edge of the clamp pulse, in pixels. Can be any value between 0 and 255. |
| Clamp width | The width of the clamp pulse can be any value between 0 and 255.   |

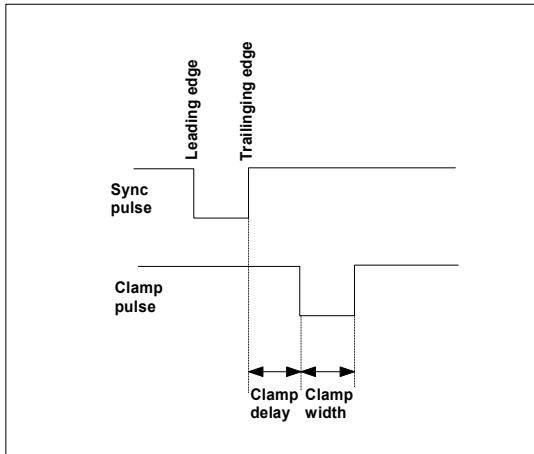


Image 9-55

### How to change the clamp delay - clamp width

1. Press **Menu** to activate the menus and select *Image* → *Timings* → *Advanced settings*.

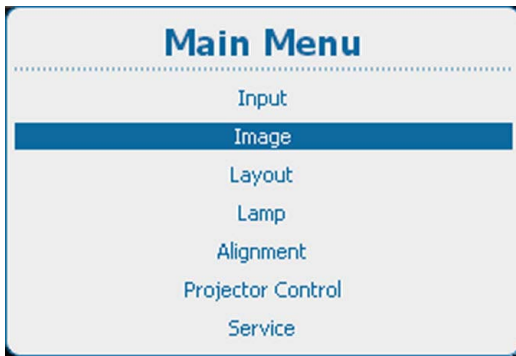


Image 9-56  
Main menu, Image

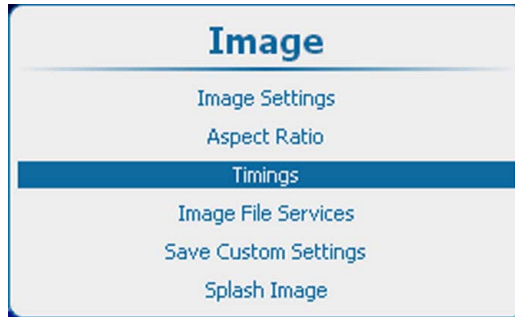


Image 9-57  
Image, timings

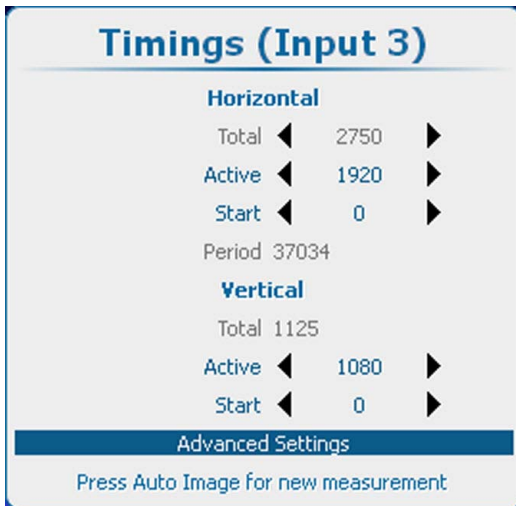


Image 9-58  
Timings, advanced settings

2. Press **ENTER** to select.

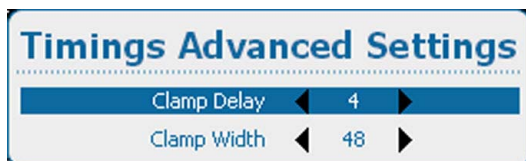


Image 9-59  
Clamp delay

- Use the ▲ or ▼ key to select *Clamp Delay* or *Clamp Width* and use the ◀ or ▶ key to change the value.  
Or,  
press **ENTER** to open the specific adjustment menu. Follow the adjustment method as described in "Navigation and adjustments", page 68.

## 9.6 Image File Services

### 9.6.1 Files and file manipulations

#### Connecting a new source.

Source dependent adjustments like image settings, aspect ratio and timings are stored in a dedicated image file.

Before using a new source, a correct image file has to be installed. The projector's memory contains a list of files corresponding to the most used sources. When the new source corresponds with one of these files, the file can be loaded and saved for future use. When there is a little difference, the file can also be loaded and then edited until the source specs are reached.

VESA standards and video standards are pre-programmed.

#### Possible file Manipulations

The following file manipulations are possible :

- Load : load the settings of a selected file for the current selected source of the active window (main or PiP)
- Rename : renaming a file.
- Delete : deleting a file (only custom files)
- Delete all : delete all custom files
- Options : way of loading a file when a source is selected.

### 9.6.2 Manual Load file

#### How to load

- Press **Menu** to activate the menus and select *Image* → *Image File Services* → *Manual Load*.

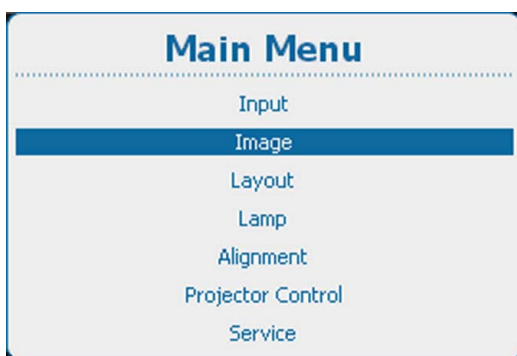


Image 9-60  
Main menu, Image

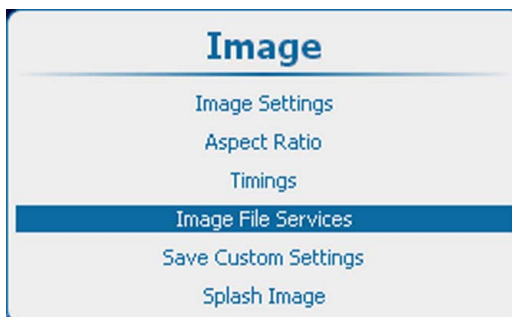


Image 9-61  
Image, image file services



Image 9-62  
Image file services

- Press **ENTER** to select.

## 9. Image

Depending on the *File Load Filter* setting a full list or a list fitting the selected source is displayed.

When staying for at least 3 seconds on the same file selection after scrolling through the list of image files a pre-load is started.



Image 9-63  
Load file

3. Use the ▲ or ▼ key to select the desired file and press **ENTER** to load this file.

### The image is not perfect

If the displayed image is not correct after selecting the best fitting file, go to the *Timings* menu and change the file settings.

### 9.6.3 File Load Filter

#### About the filter setting

Depending on the load file filter, the load list can be reduced to the fitted files or can be expanded to show all files.

[Fit] : reduced list corresponding with the input source.

[All] : full list with all available files in the projector.

#### How to set up

1. Press **Menu** to activate the menus and select *Image* → *Image File Services* → *File Load Filter*.

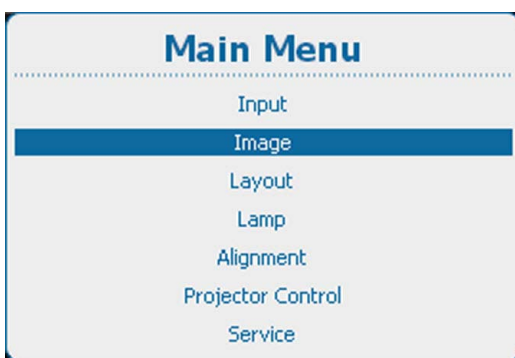


Image 9-64  
Main menu, Image

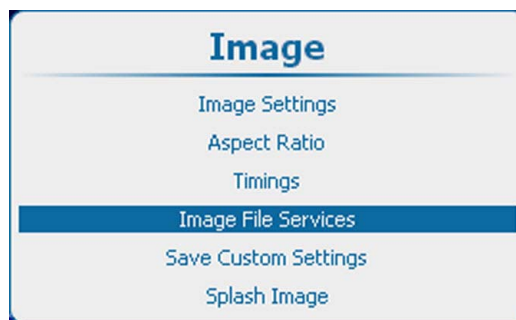


Image 9-65  
Image, image file services

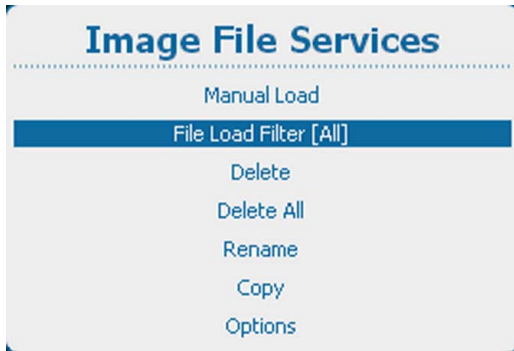


Image 9-66  
File load filter

2. Press **ENTER** to toggle between *[All]* and *[Fit]*.

### 9.6.4 Delete a file

#### What can be done ?

A custom image file can be deleted. Be aware that an active file can't be deleted.

#### How to delete

1. Press **Menu** to activate the menus and select *Image* → *Image File Services* → *Delete*.

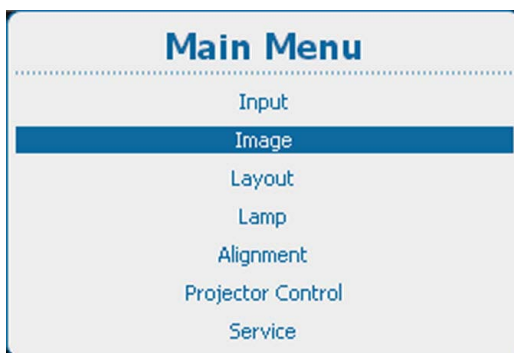


Image 9-67  
Main menu, Image

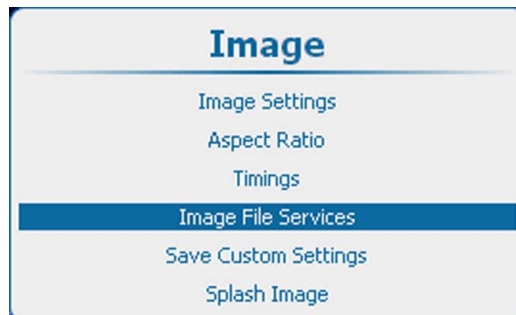


Image 9-68  
Image, image file services

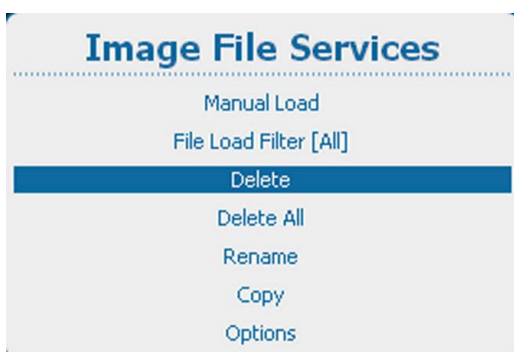


Image 9-69  
Image file services, delete

2. Press **ENTER** to select.

The available custom files are displayed.

If no custom files are available, a message that no custom files are available is displayed.

3. Use the **▲** or **▼** key to select the file to delete.

## 9. Image



Image 9-70  
Delete custom file

4. Press **ENTER** to delete the selected file.



**No recovery possible !**

### 9.6.5 Delete all custom files

#### What can be done ?

All custom image files can be deleted by executing a single command. Be aware that an active file can't be deleted.



**Image files of active sources on input 1 to 4 cannot be deleted.**

#### How to delete

1. Press **Menu** to activate the menus and select *Image* → *Image File Services* → *Delete*.

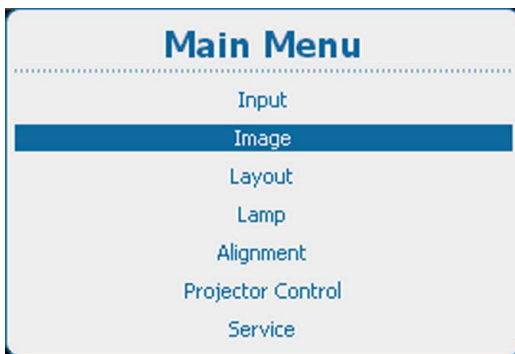


Image 9-71  
Main menu, Image

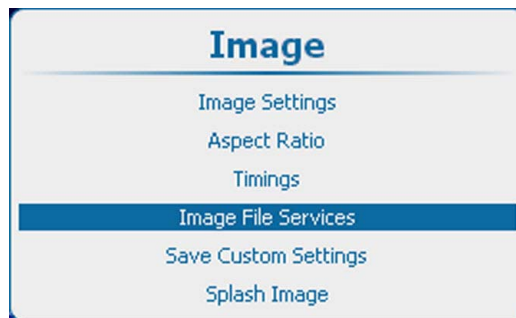


Image 9-72  
Image, image file services

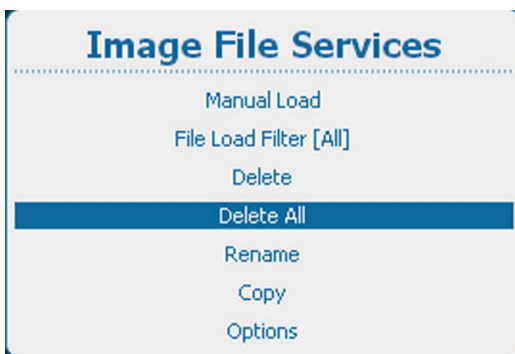


Image 9-73  
Delete all custom files

If no custom files are available, a message that no custom files are available is displayed.

2. Use the **▲** or **▼** key to select *Yes* or *No*.

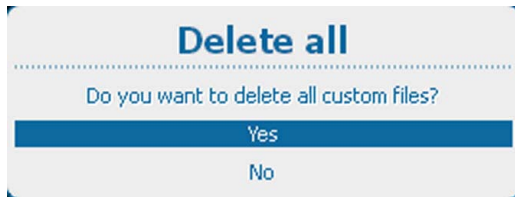


Image 9-74  
Delete all

- If **Yes** is selected, press **ENTER** to delete all custom files.  
If **No** is selected, press **ENTER** to return to the *Image File Services* menu without deleting any custom file.



**No recovery possible !**

### 9.6.6 Rename custom files



**A rename operation is only applicable for custom image files.**

#### How to rename

- Press **Menu** to activate the menus and select *Image* → *Image File Services* → *Rename*.

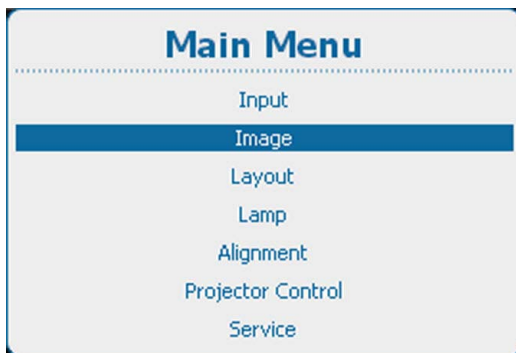


Image 9-75  
Main menu, Image

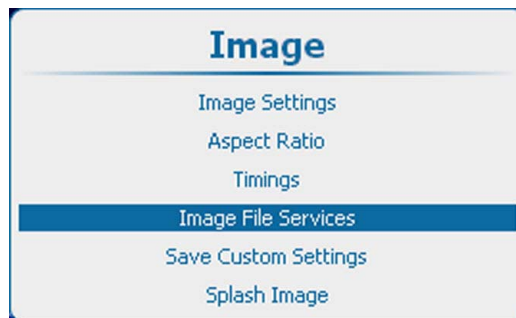


Image 9-76  
Image, image file services

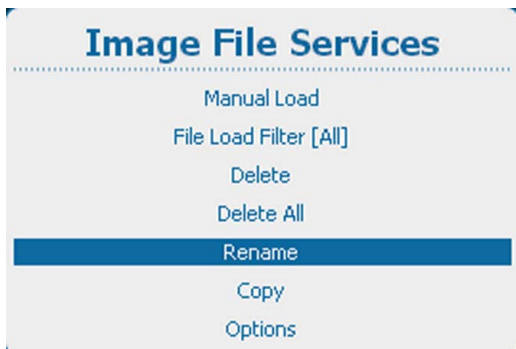


Image 9-77  
Image file services, rename

- Press **ENTER** to select.

The available custom files are displayed.

If no custom files are available, a message that no custom files are available is displayed.

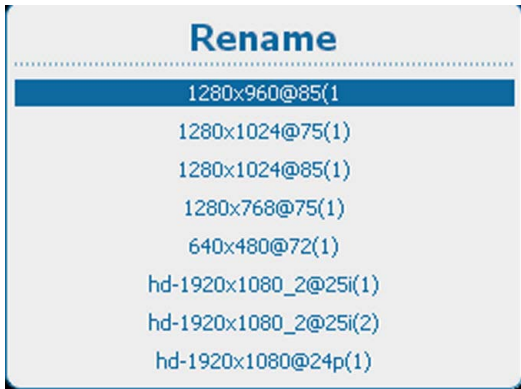


Image 9-78  
Rename, list of files

3. Use the ▲ or ▼ key to select the file to rename and press **ENTER**.

The rename window opens.



Image 9-79  
Rename file

4. Use the ▲ or ▼ key to change the selected character.  
Use the ◀ or ▶ key to select another character.

**Note:** Digits can be entered with the digit keys on the remote control or the local keypad. When a digit is entered in that way, the next character will be selected automatically. Arrow key left (◀) has the backspace functionality.

5. Press **ENTER** to finalize the rename action.

### 9.6.7 Copy custom file

#### How to copy

1. Press **Menu** to activate the menus and select *Image* → *Image File Services* → *Copy*.

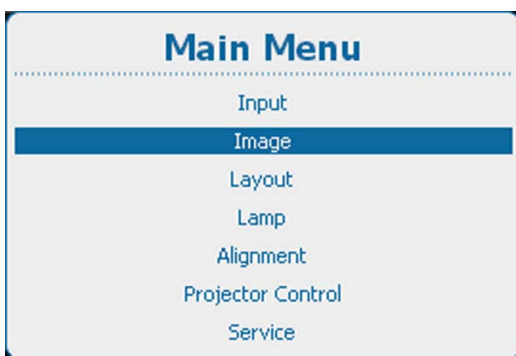


Image 9-80  
Main menu, Image

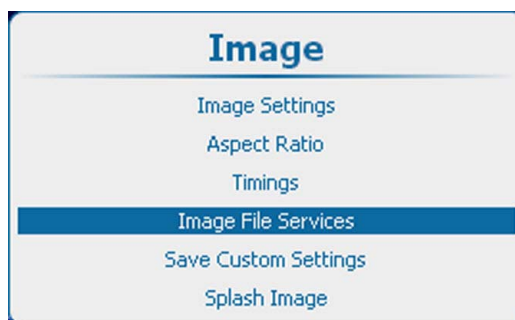


Image 9-81  
Image, image file services



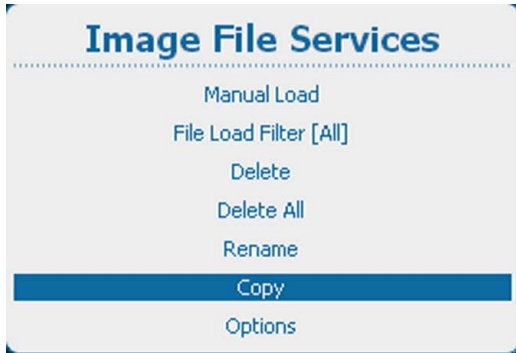


Image 9-82  
Image file services, copy

2. Press **ENTER** to select.

The available custom files are displayed.

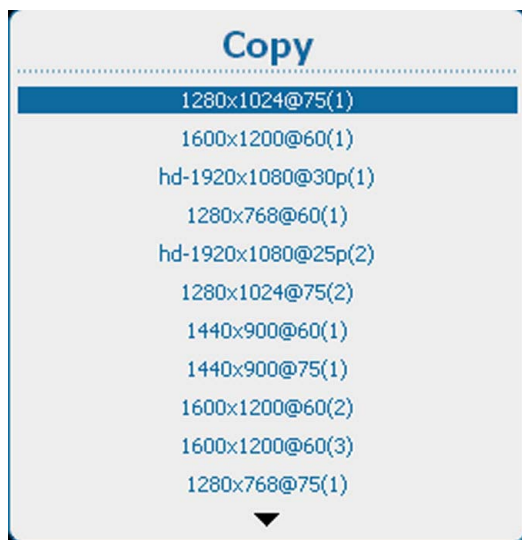


Image 9-83  
Copy files, list

If no custom files are available, a message that no custom files are available is displayed.

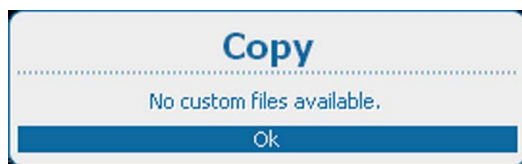


Image 9-84  
No custom files

3. Use the **▲** or **▼** key to select the file to copy and press **ENTER**.

The copy window opens.



Image 9-85  
Copy custom files

4. Use the **▲** or **▼** key to change the selected character.  
Use the **◀** or **▶** key to select another character.

**Note:** Digits can be entered with the digit keys on the remote control or the local keypad. When a digit is entered in that way, the next character will be selected automatically. Arrow key left (**◀**) has the backspace functionality.

### 9.6.8 Image file service options, Load file

#### How to set

1. Press **Menu** to activate the menus and select *Image* → *Image File Services* → *Options* → *Load File*.

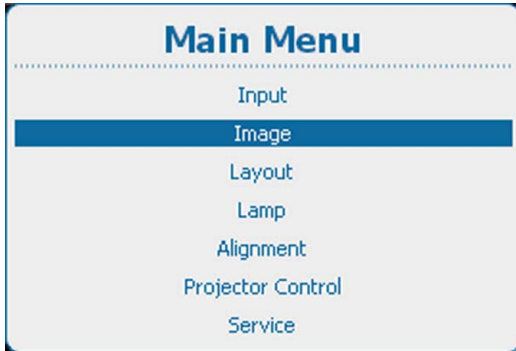


Image 9-86  
Main menu, Image

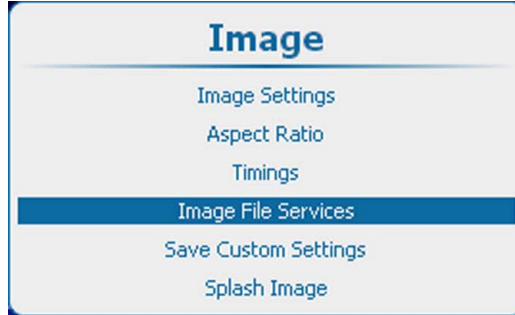


Image 9-87  
Image, image file services



Image 9-88  
Image file services, Options



Image 9-89  
File options, Load file

2. Press **ENTER** to toggle between *[Automatic]*, *[Manual]* or *[Custom only]*.
  - Automatic : correct file will be loaded automatically.
  - Manual : correct file should be loaded manually.
  - Custom only : correct file will be loaded automatically out of the available custom files.

### 9.6.9 Image file service options, Auto Picture Alignment

#### How to set

1. Press **Menu** to activate the menus and select *Image* → *Image File Services* → *Options* → *Auto Picture Alignment*.

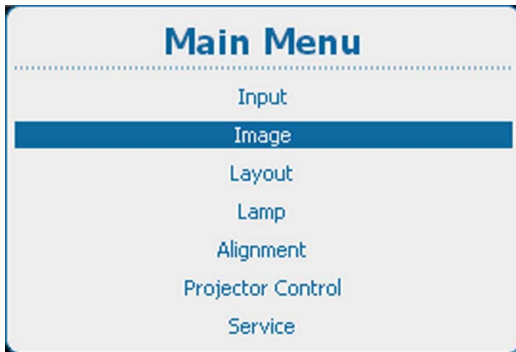


Image 9-90  
Main menu, Image

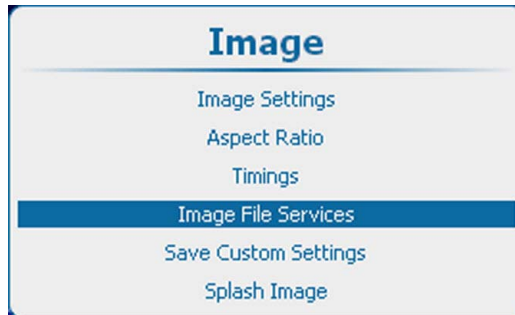


Image 9-91  
Image, image file services



Image 9-92  
Image file services, Options



Image 9-93  
File options, Auto Picture Alignment

2. Press **ENTER** to toggle between *[Off]*, *[Always]* or *[Load File]*.
  - Off : auto picture alignment deactivated.
  - Always : auto picture alignment is always activated.
  - Load file: when new file is loaded for the selected source.

## 9.7 Save custom settings

### What can be done ?

The current custom settings can be saved to internal backup device in the same way as it would be done when the projector lamp was switched off.

When settings are changed when the lamp is off, a manual Save custom settings must be executed to save the changes.

When the message Save changes is displayed, newer switch off the projector.

### How to save

1. Press **Menu** to activate the menus and select *Image* → *Save Custom Settings*

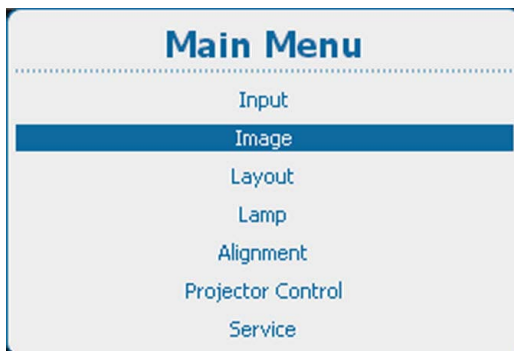


Image 9-94  
Main menu, Image

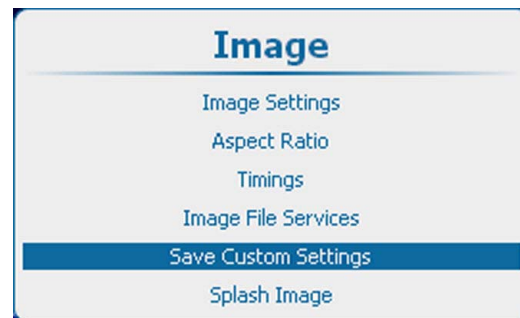


Image 9-95  
Image, save custom settings

2. Use the **▲** or **▼** key to select Yes and press **ENTER**.



Image 9-96  
Save custom settings, question

## 9.8 Splash image

### About a splash image

When splash image is on, a dedicated image is displayed after start up and before the normal image is displayed and that for a certain time.

A splash image can be uploaded via Projector Toolset. For more information about uploading a splash image, consult Projector Toolset's user guide.

### Enable or disable the splash image

1. Press **Menu** to activate the menus and select *Image* → *Splash image*

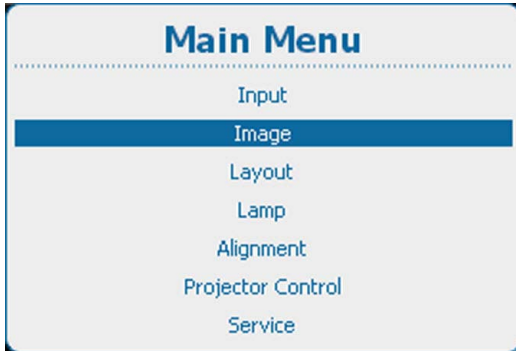


Image 9-97  
Main menu, Image

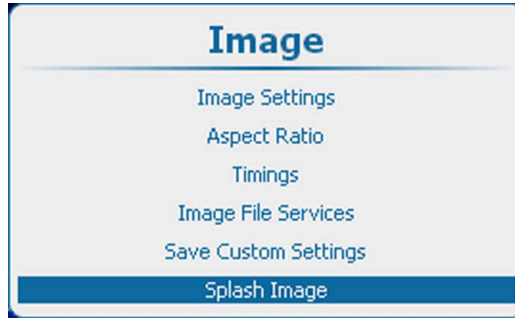


Image 9-98  
Image, splash image

2. Select *Splash image*.



Image 9-99  
Splash image, enabling

3. Press **ENTER** to toggle between *[On]* or *[Off]*.

On A splash screen will be displayed at each startup for a certain time (time out)

Off No splash screen is displayed at startup

### Time-out setup

1. Press **Menu** to activate the menus and select *Image* → *Splash image*

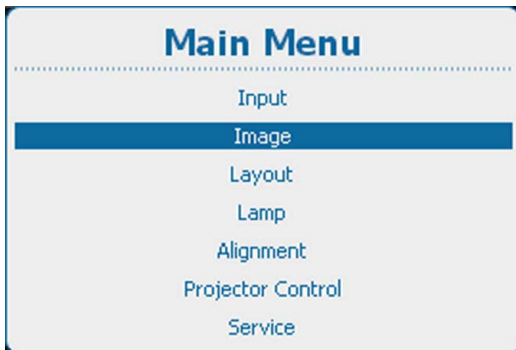


Image 9-100  
Main menu, Image

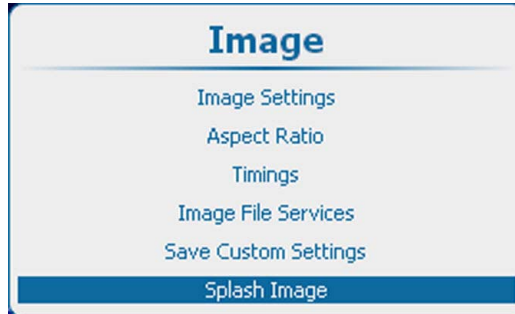


Image 9-101  
Image, splash image

2. Select *Timeout(sec)*



Image 9-102  
Splash screen, time-out

3. Press **ENTER** to open the edit mode.  
Enter the time with 2 digits, e.g. 05 or 15.  
**Note:** *Maximum timeout = 15 seconds.*



Image 9-103  
Time-out, input



# 10. LAYOUT

## Overview

- Layout menu overview
- Introduction
- Main window
- PiP window
- Layout File Services
- Lens behavior

## 10.1 Layout menu overview

### Overview table

Level 1	Level 2	Level 3	Level 4
Layout			
	Main Window	Source Size Position	
	Pip Window	Pip Window [On], [Off] Source Size Position	
	Layout File Services	Load	Main Full Screen Native Resolution Pip Up Right Split Left Right Split Top Bottom Custom x
		Rename Delete Delete all Copy/Save as	
	Lens behavior	Same zoom/focus/shift [yes], [no]	

## 10.2 Introduction

### Overview

Layout files determine the size and the position of the main and PiP window on the screen. Some pre-defined layouts are available in the projector but custom layouts can be created and saved for future use. A source number and lens settings can be associated with the layout settings.

## 10.3 Main window

### Overview

- Main window source selection
- Main window size
- Main window position



When starting the Main window settings, the system will ask to create a custom layout

### 10.3.1 Main window source selection

#### How to select

1. Press **Menu** to activate the menus and select *Layout* → *Main window* → *Source*.

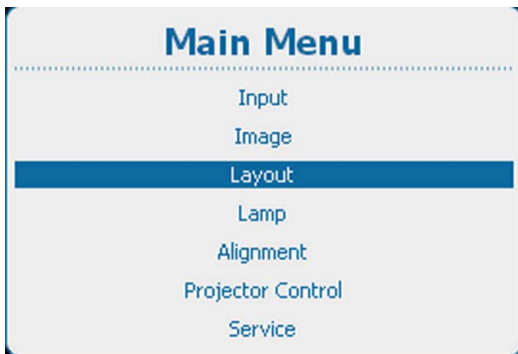


Image 10-1  
Main menu, layout



Image 10-2  
Layout, main window



Image 10-3  
Main window, source

2. Press **ENTER** to select.

The *Select Source* window opens.

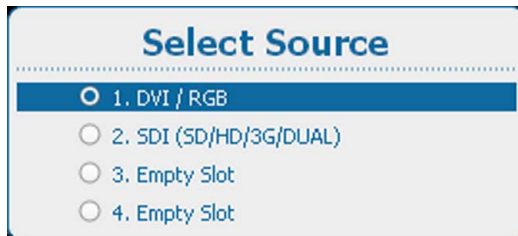


Image 10-4  
Select source

3. Use the **▲** or **▼** key to select the desired source and press **ENTER**.

The radio button of the selected source is checked and the source is linked with the main window.

### 10.3.2 Main window size

#### What can be done?

The size of the main window can be adjusted until the desired window dimensions are reached.



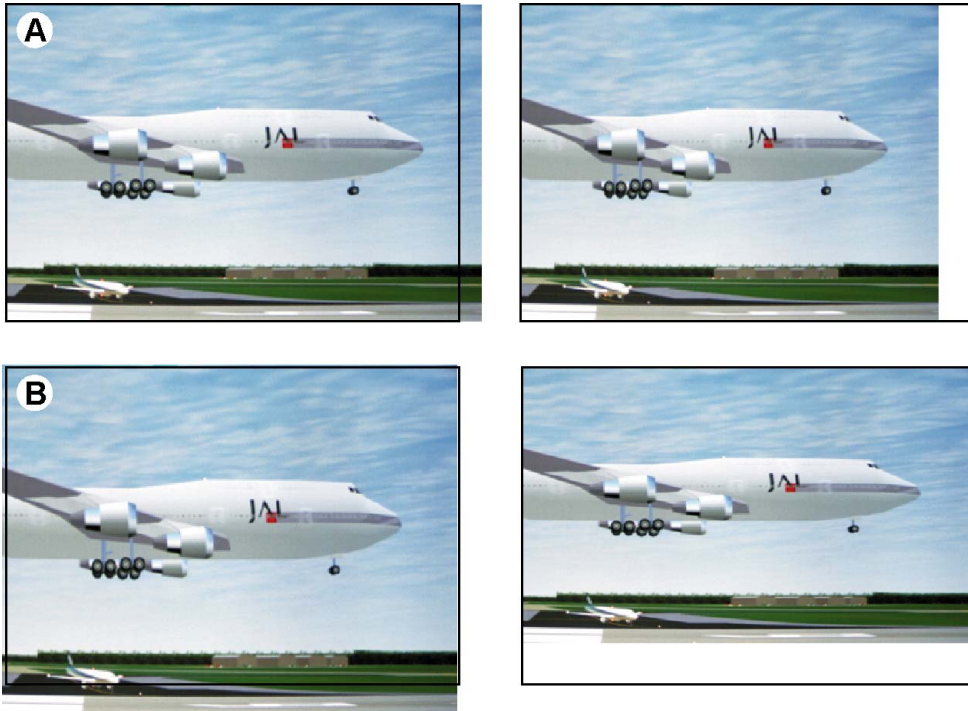


Image 10-5  
Size adjustment main window

- A width adjustment
- B height adjustment

The size can be changed with respect to the original aspect ratio by checking the check box in front of *Lock*.

### How to change the size

1. Press **Menu** to activate the menus and select *Layout* → *Main window* → *Size*.

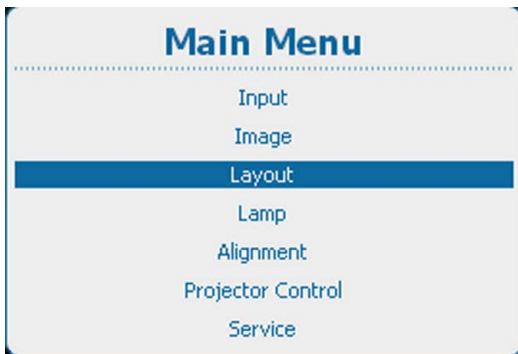


Image 10-6  
Main menu, layout



Image 10-7  
Layout, main window



Image 10-8  
Main window, size

2. Press **ENTER** to select.

The *Size* window opens.



Image 10-9  
Size window

3. To keep the current aspect ratio, press **ENTER** to check *Lock*.

Once *Lock* is checked, the width and the height will follow each other when changing one of the dimensions.

4. Use the ▲ or ▼ key to change the height and the ◀ or ▶ key to change the width.
5. When the desired size is reached, press **EXIT**.

A *Save Layout* window opens.



Image 10-10  
Save layout

6. Use the ▲ or ▼ key to select *Yes* and press **ENTER** to save.  
Select *No* if you want to quit without saving the current position.

### 10.3.3 Main window position

#### What can be done?

The main window can be repositioned on the screen. The upper left corner is the reference.

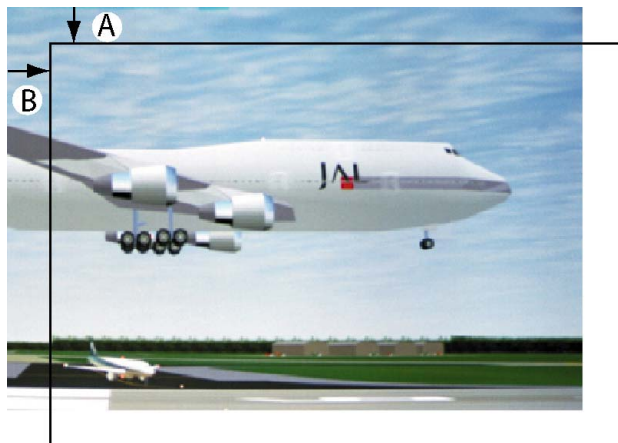


Image 10-11  
Positioning the window

#### How to position

1. Press **Menu** to activate the menus and select *Layout* → *Main window* → *Position*.

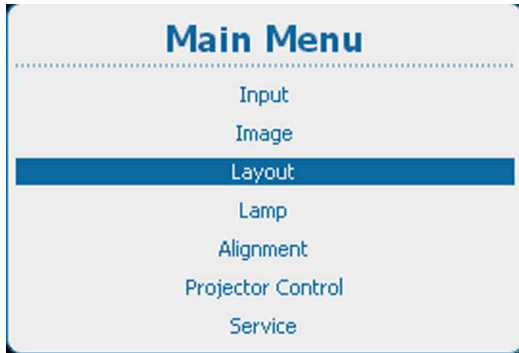


Image 10-12  
Main menu, layout



Image 10-13  
Layout, main window



Image 10-14  
Main window, Position

2. Press **ENTER** to select.

The *Position* window opens.



Image 10-15  
Position window

3. Use the **▲** or **▼** key to change the *Top* position and the **◀** or **▶** key to change the *Left* position.
4. When desired position is reached, press **EXIT**.

A *Save Layout* window opens.

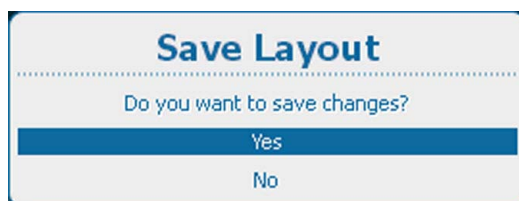


Image 10-16  
Save layout

5. Use the **▲** or **▼** key to select *Yes* and press **ENTER** to save.  
Select *No* if you want to quit without saving the current position.

## 10.4 PiP window

### Overview

- Introduction to PiP
- Picture in Picture activation
- PiP window, source selection
- PiP window, Size
- PiP window, position



When starting the PiP window settings, the system will ask to create a custom layout

### 10.4.1 Introduction to PiP



#### PiP

PiP stands for "Picture in Picture" and allows to display multiple windows containing each of them an image. The windows may be of the video or data type.

#### What are the different possibilities within the PiP mode ?

The input section of the projector allows a combination of different input signals which may be projected in the 2 windows, main and PiP. The PiP window can be placed anywhere, with any dimensions, on the screen by changing its position and its size.

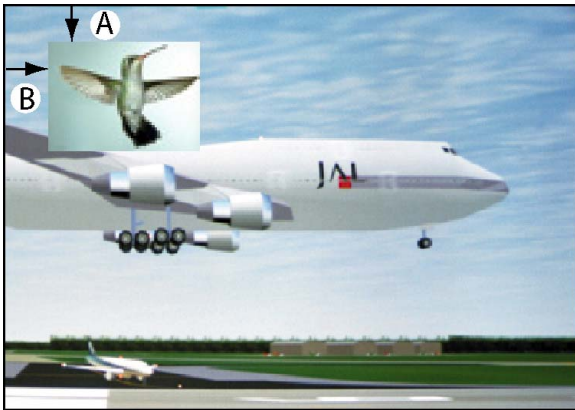


Image 10-17  
Position of PiP

- A Top position
- B Left position

### 10.4.2 Picture in Picture activation

#### How to activate

1. Press **Menu** to activate the menus and select *Layout* → *PiP window* → *PiP window [On] / [Off]*.

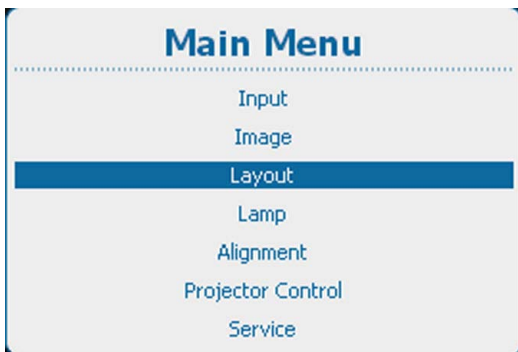


Image 10-18  
Main menu, layout



Image 10-19  
Layout, PiP Window

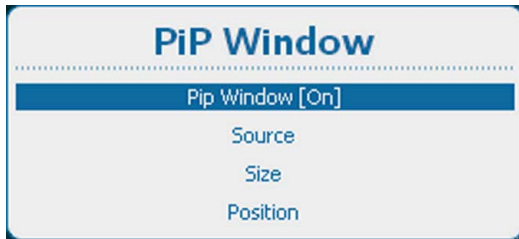


Image 10-20  
PiP window, activation

2. Press **ENTER** to toggle between *[On]* or *[Off]*.

### 10.4.3 PiP window, source selection

#### How to select

1. Press **Menu** to activate the menus and select *Layout* → *PiP window* → *Source*.

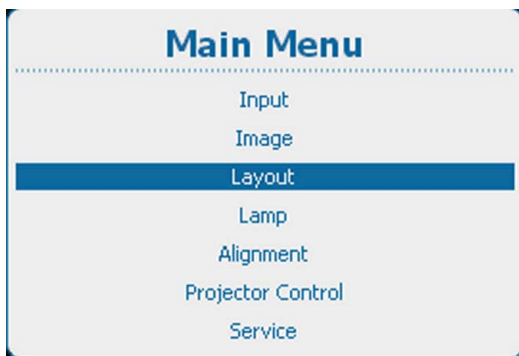


Image 10-21  
Main menu, layout



Image 10-22  
Layout, PiP Window



Image 10-23  
PiP window, source selection

2. Press **ENTER** to select.

The *Select Source* window opens.

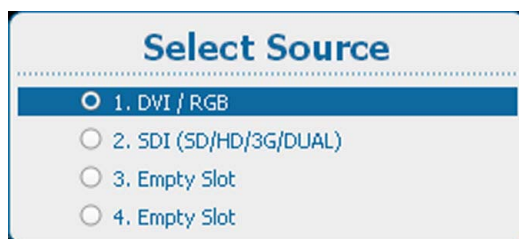


Image 10-24  
Select source

3. Use the **▲** or **▼** key to select the desired source and press **ENTER**.

The radio button of the selected source is checked and the source is linked with the PiP window.



**PiP source and main source can be the same input.**

### 10.4.4 PiP window, Size

#### What can be done?

The width and height of the picture in picture window can be changed till the desired dimensions are obtained.

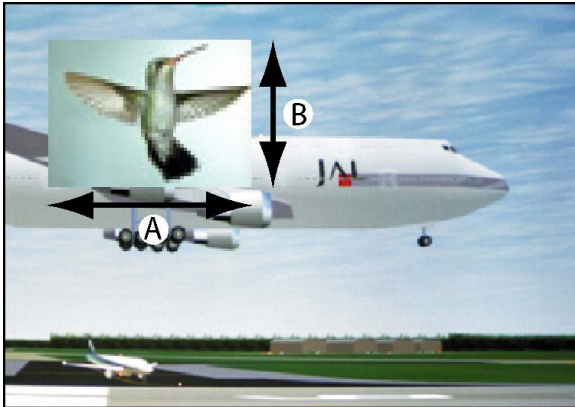


Image 10-25  
Size PiP window

- A Width PiP window
- B Height PiP window

The size of the picture in picture window can be changed with respect to the original aspect ratio of the PiP image.

Remark: During adjustment of the window size, scaling artifacts can be visible.



Image 10-26  
Size PiP window remark

#### How to resize

1. Press **Menu** to activate the menus and select *Layout* → *PiP window* → *Size*.

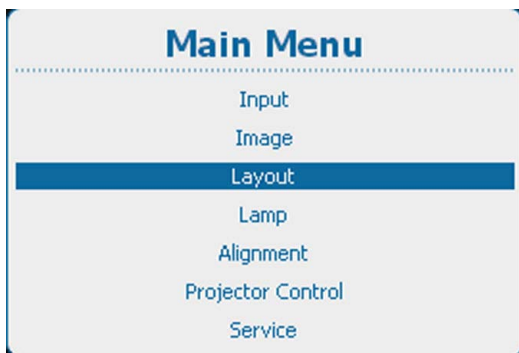


Image 10-27  
Main menu, layout



Image 10-28  
Layout, PiP Window



Image 10-29  
PiP window, size

2. Press **ENTER** to select.

The *Size* window opens.



Image 10-30  
PiP window, resize

3. To keep the current aspect ratio, press **ENTER** to check *Lock*.

Once *Lock* is checked, the width and the height will follow each other when changing one of the dimensions.

4. Use the ▲ or ▼ key to change the height and the ◀ or ▶ key to change the width.
5. When the desired size is reached, press **EXIT**.

A *Save Layout* window opens.

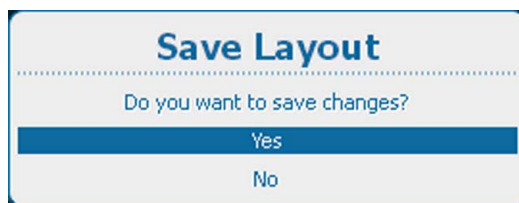


Image 10-31  
Save layout

6. Use the ▲ or ▼ key to select *Yes* and press **ENTER** to save.  
Select *No* if you want to quit without saving the current position.

### 10.4.5 PiP window, position

#### What can be done?

The picture in picture window can be positioned on any place on the display just by changing its start coordinates. The reference is the upper left corner of the window.

#### How to position

1. Press **Menu** to activate the menus and select *Layout* → *PiP window* → *Position*.

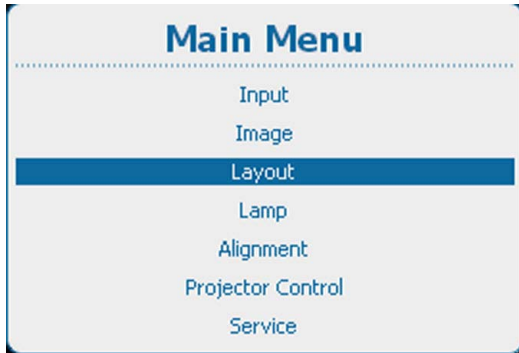


Image 10-32  
Main menu, layout



Image 10-33  
Layout, PIP window



Image 10-34  
PiP window, position

2. Press **ENTER** to select.

The *Position* window opens.



Image 10-35  
Position window

3. Use the **▲** or **▼** key to change the *Top* position and the **◀** or **▶** key to change the *Left* position.
4. When desired position is reached, press **EXIT**.

A *Save Layout* window opens.

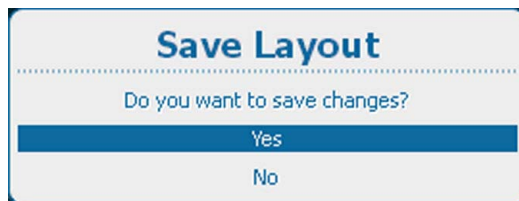


Image 10-36  
Save layout

5. Use the **▲** or **▼** key to select **Yes** and press **ENTER** to save.  
Select **No** if you want to quit without saving the current position.



## 10.5 Layout File Services

### Overview

- Load layout file
- Rename layout file
- Delete layout file
- Delete all layout files
- Copy or Save as layout file

### 10.5.1 Load layout file



When loading a layout that requires two sources, the PiP window On/Off setting will be switched to On.

### How to load file

1. Press **Menu** to activate the menus and select *Layout* → *Layout File Services* → *Load*.

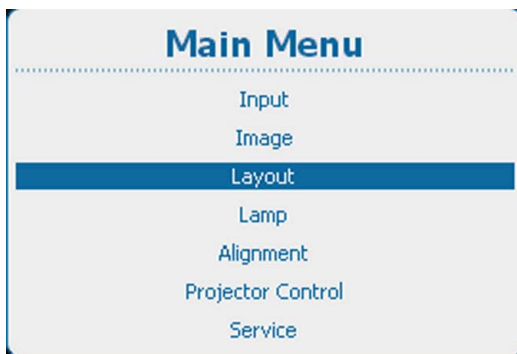


Image 10-37  
Main menu, layout



Image 10-38  
Layout, layout file services

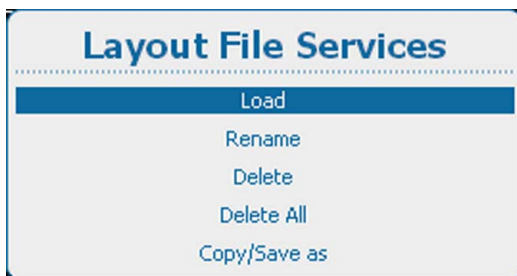


Image 10-39  
Layout file services, load

2. Press **ENTER** to select.

The *Load layout* overview window opens.

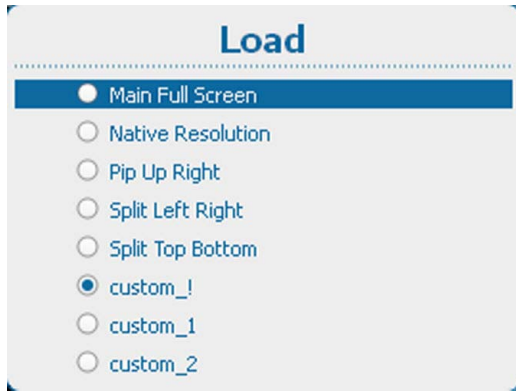


Image 10-40  
Load layout file list

3. Use the ▲ or ▼ key to select the desired file and press **ENTER** to activate.  
The radio button in front of the selected file is checked.

### 10.5.2 Rename layout file



Only custom created layouts can be renamed.

#### How to rename

1. Press **Menu** to activate the menus and select *Layout* → *Layout File Services* → *Rename*.

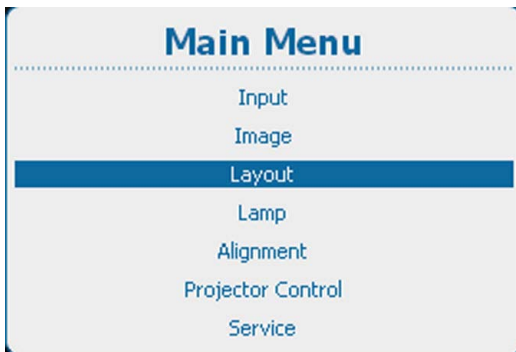


Image 10-41  
Main menu, layout



Image 10-42  
Layout, layout file services

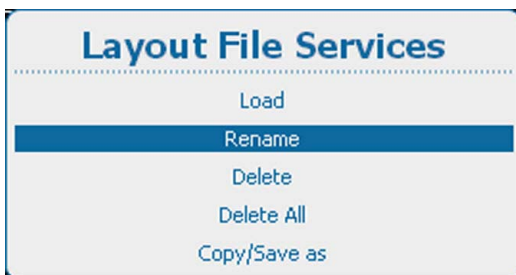


Image 10-43  
Layout file services, rename

2. Press **ENTER** to select.

The *Rename layout* window opens with all available custom layouts.



Image 10-44

- Use the ▲ or ▼ key to select the desired custom file and press **ENTER** to start the renaming.

The Rename window opens.

Image 10-45  
Rename layout

- Use the ▲ or ▼ key to change the selected character.  
Use the ◀ or ▶ key to select another character.

**Note:** Digits can be entered with the digit keys on the remote control or the local keypad. When a digit is entered in that way, the next character will be selected automatically. Arrow key left (◀) has the backspace functionality.

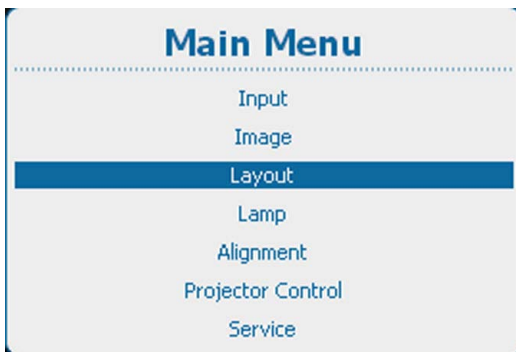
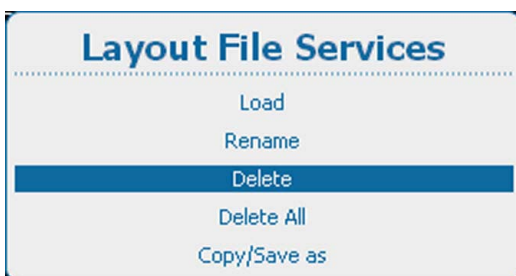
### 10.5.3 Delete layout file



Only custom created layouts can be deleted. The current selected custom layout cannot be deleted.

#### How to delete

- Press **Menu** to activate the menus and select *Layout* → *Layout File Services* → *Delete*.

Image 10-46  
Main menu, layoutImage 10-47  
Layout, layout file servicesImage 10-48  
Layout file services, delete

- Press **ENTER** to select.

The *Delete layout* window opens with all available custom layouts.

If no custom layout files are available, a message that no custom layout files are available is displayed.

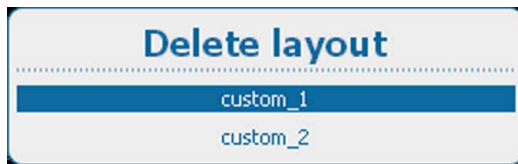


Image 10-49

3. Use the ▲ or ▼ key to select the desired custom file and press **ENTER** to delete.

A confirmation window is displayed.

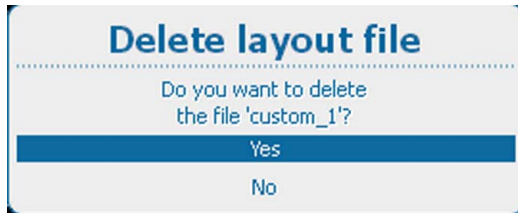


Image 10-50

4. Use the ▲ or ▼ key to select Yes and press **ENTER** to delete the custom layout. Select *No* if you want to quit without deleting the custom file.

### 10.5.4 Delete all layout files



Only custom layout files can be deleted. The current selected custom layout cannot be deleted.

#### How to delete

1. Press **Menu** to activate the menus and select *Layout* → *Layout File Services* → *Delete All*.

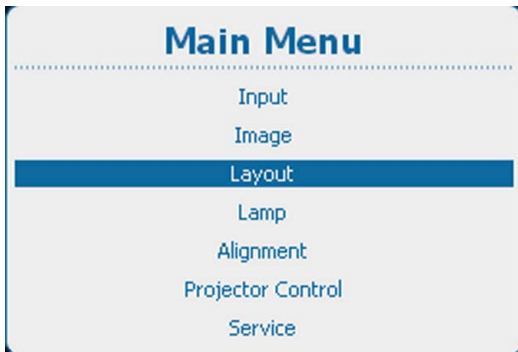


Image 10-51  
Main menu, layout



Image 10-52  
Layout, layout file services

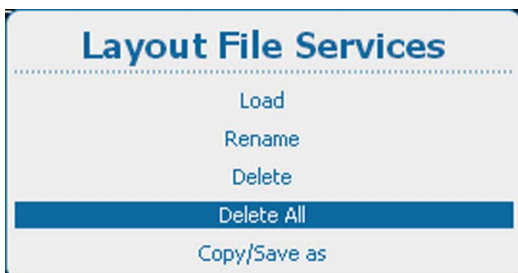


Image 10-53  
Layout file services, delete all

2. Press **ENTER** to select.

The *Delete all* confirm window opens.

If no custom files are available, a message that no custom files are available is displayed.

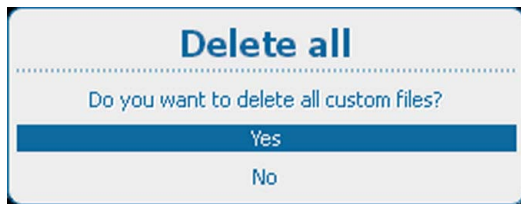


Image 10-54  
Layout files, delete all confirmation

- Use the ▲ or ▼ key to select Yes. Press **ENTER** to delete all layout files.

### 10.5.5 Copy or Save as layout file

#### What can be done?

The current loaded layout, custom layout or custom created layout, can be copied into a new file.

#### How to copy / save as

- Press **Menu** to activate the menus and select *Layout* → *Layout File Services* → *Copy/Save as*.

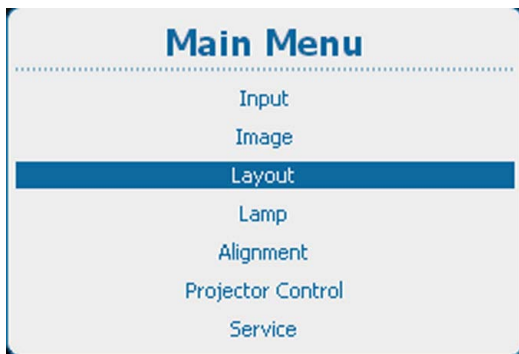


Image 10-55  
Main menu, layout



Image 10-56  
Layout, layout file services

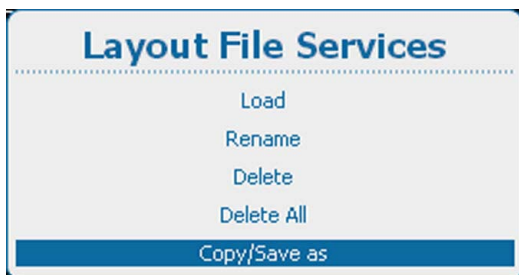


Image 10-57  
Layout file services, copy/save as

- Press **ENTER** to select.

The *Copy layout file* window opens.

If no custom layout files are available, a message that no custom layout files are available is displayed.



Image 10-58  
Copy layout

- Use the ▲ or ▼ key to change the selected character.

Use the ◀ or ▶ key to select another character.

**Note:** Digits can be entered with the digit keys on the remote control or the local keypad. When a digit is entered in that way, the next character will be selected automatically. Arrow key left (◀) has the backspace functionality.

## 10.6 Lens behavior

### What can be done ?

Different custom layouts can have different zoom/focus/shift (lens) settings, e.g. when using the projector on 2 different projector distances or two different screen sizes (same image but 2 custom layouts needed due to different zoom/focus/shift settings).

Adjust the lens settings for the different situations and save these settings each in a different custom layout.

When using only one screen to project the different layouts, the same lens settings can be used for all custom layouts.

When using different screens, different lens settings can be used (settings saved in the custom file will be used). To use different lens settings, it is important that the lens is calibrated so that the lens always returns to the saved position when opening a custom layout.

Switching from a custom file (layout) to a standard file (layout) will not change the current lens settings.

### How to set the lens behavior

1. Press **Menu** to activate the menus and select *Layout* → *Lens behavior*.

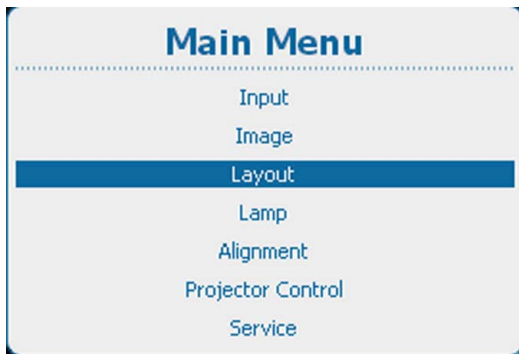


Image 10-59  
Main menu, layout



Image 10-60  
Layout, Lens behavior

2. Press **ENTER** to select.

The *Lens behavior* window opens.



Image 10-61  
Lens behavior setting

3. Press **ENTER** to toggle lens behavior between *[Yes]* or *[No]*.

[Yes] = each layout will use the same zoom/focus/shift settings. The zoom/focus/shift settings of the previous selected layout will be applied to the next selected layouts.

[No] = each layout will use its own zoom/focus/shift settings. Lens should be calibrated, when using this setting.

4. If *[No]* is selected, the calibrate lens menu opens.

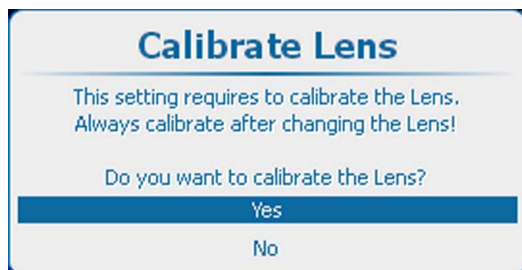


Image 10-62  
Lens calibration

---

Before different zoom/focus/shift setting can be used, the lens should be calibrated. When a lens change has taken place, always calibrate the lens before using this setting.

5. If you have to calibrate the lens, select Yes and press **ENTER** to start the calibration.

During the calibration, a message is displayed. This message disappears when the calibration is finished.

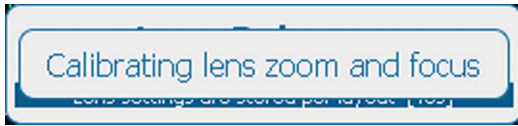


Image 10-63  
Lens calibration message





# 11. LAMP

## Overview

- Lamp menu overview
- Lamp power mode
- Lamp power
- Auto dimming when on Pause
- Auto dimming when No Signal
- Auto dimming when Over-temperature
- CLO mode (Constant light output mode)
- CLO targets
- LPS power
- Lamp identification
- Z-axis adjustment

## 11.1 Lamp menu overview

### Overview table

Level 1	Level 2	Level 3
Lamp		
	Power	Power mode Power Auto dimming when pause Auto dimming when No Signal Auto dimming when Overtemperature CLO mode CLO targets LPS Power
	Identification	
	Z-axis	Light output

## 11.2 Lamp power mode

### What can be done?

The lamp power mode can be switched between **Normal**, **Economic** and **Long Life**. When playing in Economic and Long Life mode, the lamp life time will be higher than in normal mode.

The counter of the lamp life time counts equal for normal or economic mode but the customer will see that the ageing of the lamp is lower in economic and long life mode.

Normal : maximum allowed power is fed to the lamp. Maximum light output is reached in this way.

Economic : a reduced wattage is fed to the lamp. Reduced light output but a longer life time for the lamp.

Long Life : wattage fed to the lamp reduce to 75%. Reduced light output but a longer life time for the lamp.

The lamp power mode setting is linked with the CLO mode setting. When CLO mode settings is set to *On*, the lamp power mode setting is ignored and projector will play in CLO mode. Once the CLO mode setting is switched to *Off*, the installed lamp power mode setting will be used.

### How to switch

1. Press **Menu** to activate the menus and select *Lamp* → *Power* → *Mode*.

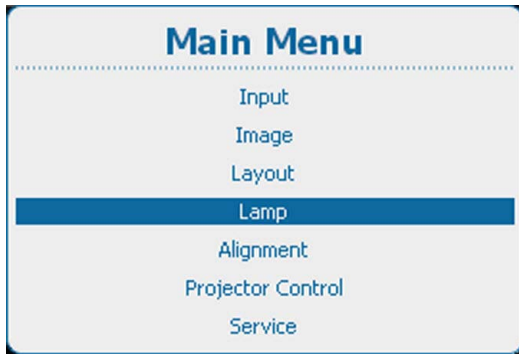


Image 11-1  
Main menu, lamp

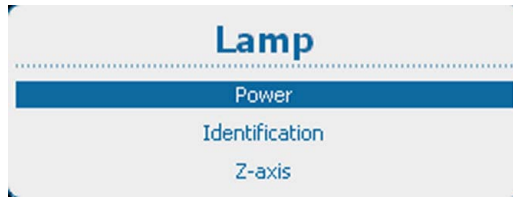


Image 11-2  
Lamp, power

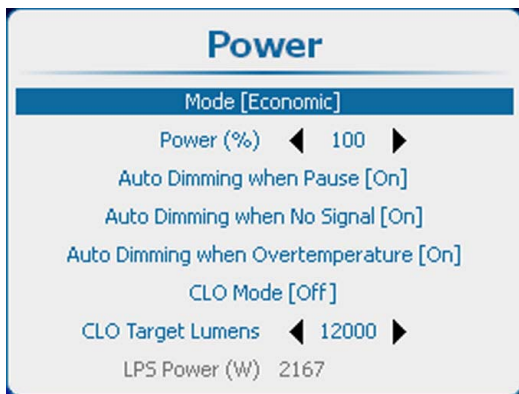


Image 11-3

2. Press **ENTER** to toggle between *[Normal]*, *[Economic]* and *[Long Life]*.

### 11.3 Lamp power

#### What can be done?

Within a certain power mode, the light output of the lamp can be reduced by reducing the lamp power

#### How to reduce the power

1. Press **Menu** to activate the menus and select *Lamp* → *Power* → *Power*.

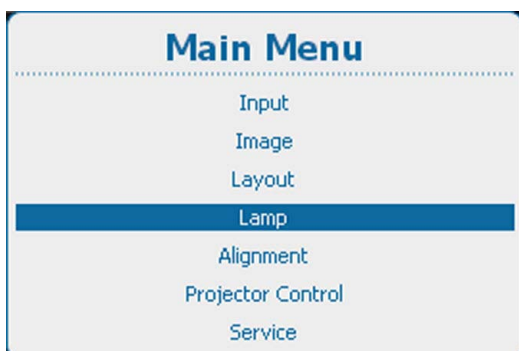


Image 11-4  
Main menu, lamp

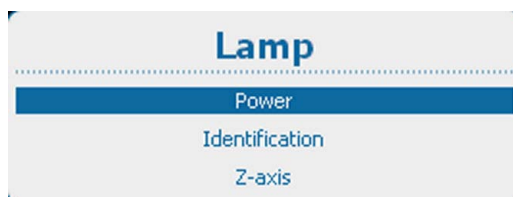


Image 11-5  
Lamp, power

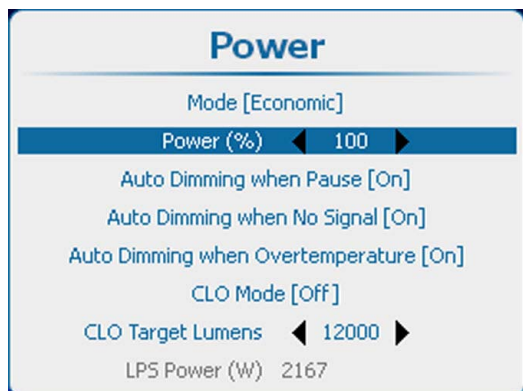


Image 11-6  
Lamp power adjustment

- Use the ◀ or ▶ key to change the power value.  
The value can be changed between 75 and 100%

## 11.4 Auto dimming when on Pause

### About auto dimming when on pause

When the projector is switched to pause, the shutter is closed but the lamp is still running on full power. When auto dimming on pause is activated, then the lamp power will be reduced from its current value to its minimum value. When returning out of pause the lamp power is restored to its previous value.

### How to set up

- Press **Menu** to activate the menus and select *Lamp* → *Power* → *Auto Dimming when Pause*.

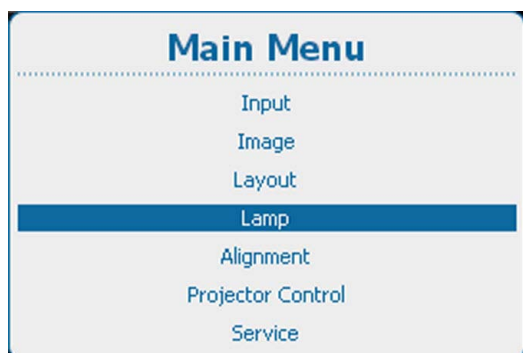


Image 11-7  
Main menu, lamp

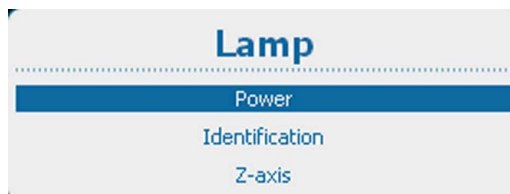


Image 11-8  
Lamp, power

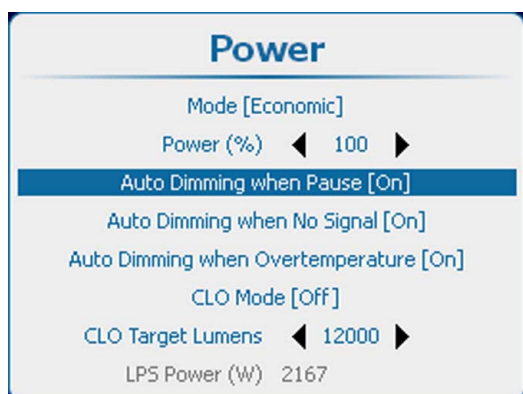


Image 11-9  
Auto dimming when Pause

- Press **ENTER** to toggle between *[On]* or *[Off]*.

## 11. Lamp

---

[On] : when switched to pause, lamp power will be reduced.

[Off] : when switched to pause, power remains on its original value.

### 11.5 Auto dimming when No Signal

---

#### About auto dimming

When no signal is detected on the selected input the lamp power will be reduced from the current value to its minimum value. When the input signal is re-detected, the lamp power is restored to its original value.

This function is a duplicate of the Auto dimming in the Input menu.

#### How to set up

1. Press **Menu** to activate the menus and select *Lamp* → *Power* → *Auto Dimming No Signal*.

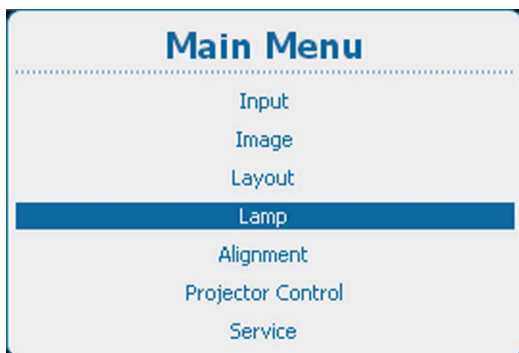


Image 11-10  
Main menu, lamp

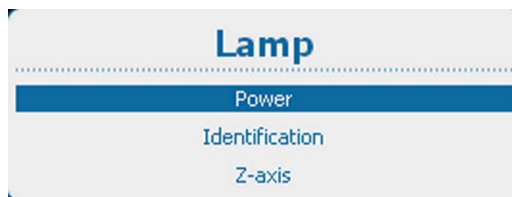


Image 11-11  
Lamp, power

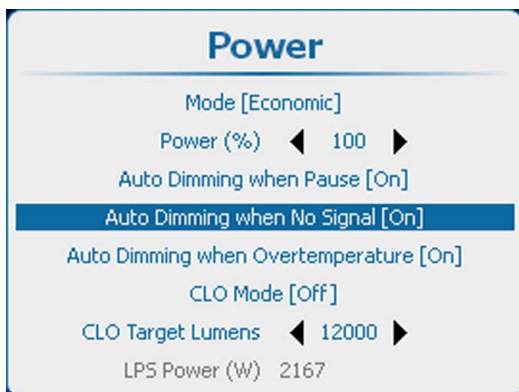


Image 11-12  
Auto dimming no signal

2. Press **ENTER** to toggle between [On] or [Off].

[On] : when no signal, auto dimming is started.

[Off] : when no signal, no auto dimming is started.

### 11.6 Auto dimming when Over-temperature

---

#### What can happen?

When an over-temperature is detected, the projector starts dimming the lamp so that the projector can cool down.

#### How to set up

1. Press **Menu** to activate the menus and select *Lamp* → *Power* → *Auto Dimming Overtemperature*.

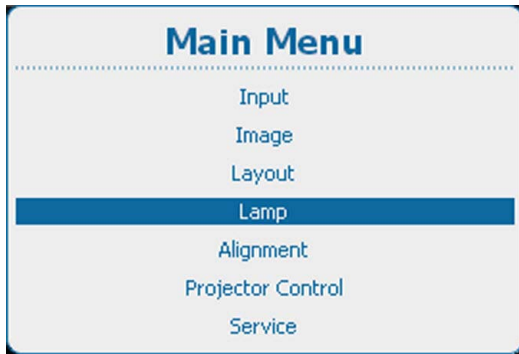


Image 11-13  
Main menu, lamp

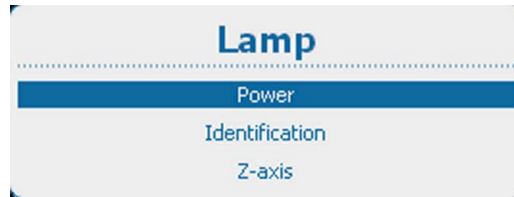


Image 11-14  
Lamp, power

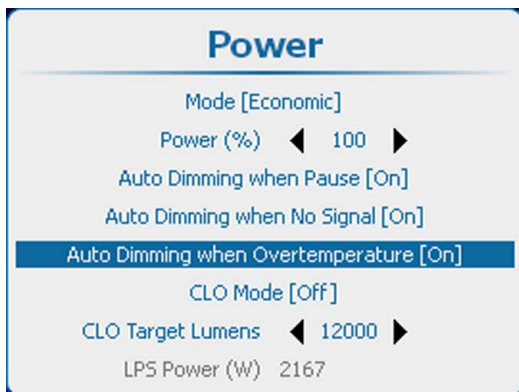


Image 11-15  
Auto dimming over-temperature

2. Press **ENTER** to toggle between *[On]* or *[Off]*.
  - [On] : when temperature is to high, auto dimming is started.
  - [Off] : when temperature is to high, no auto dimming is started.

## 11.7 CLO mode (Constant light output mode)

### What can be done?

Constant Light Output allows to force a constant light output (set in the *CLO Target lumens* item) of the projector over a certain period. This will eliminate uncontrolled light output drop caused by natural aging of the lamp. The light output is checked every 5 minutes, if the target is not met, the lamp power is adjusted.

Setting CLO off means that the lamp will operate at constant power (no power adaptation to meet constant light output).

In the illustration below, a normal light output curve is shown over the first 1000 hours, image 11-16. By using CLO and setting the target to 60% of the maximum light output, one will be able to operate during approximately 500 hours with a constant light output, image 11-17.

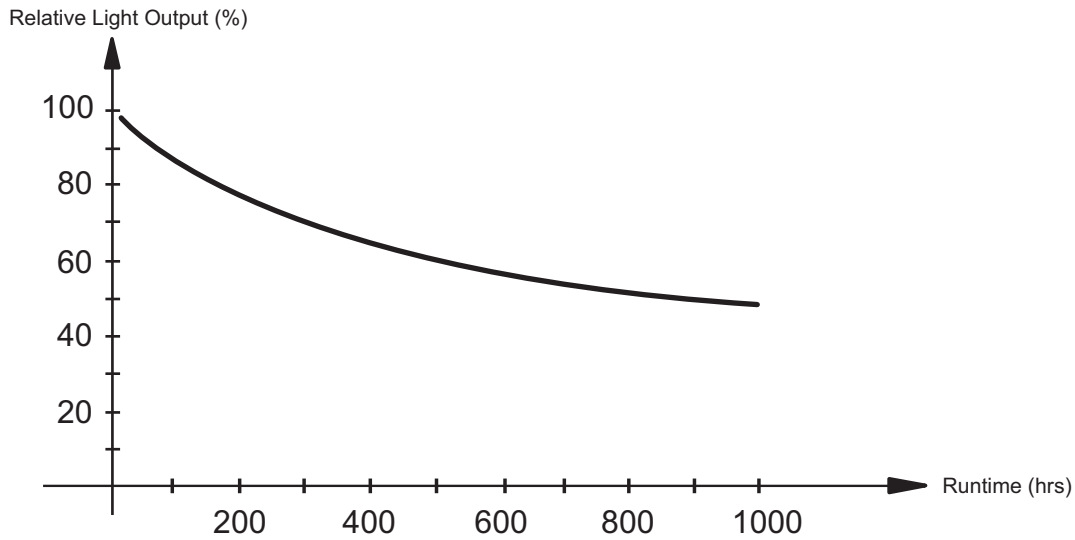


Image 11-16

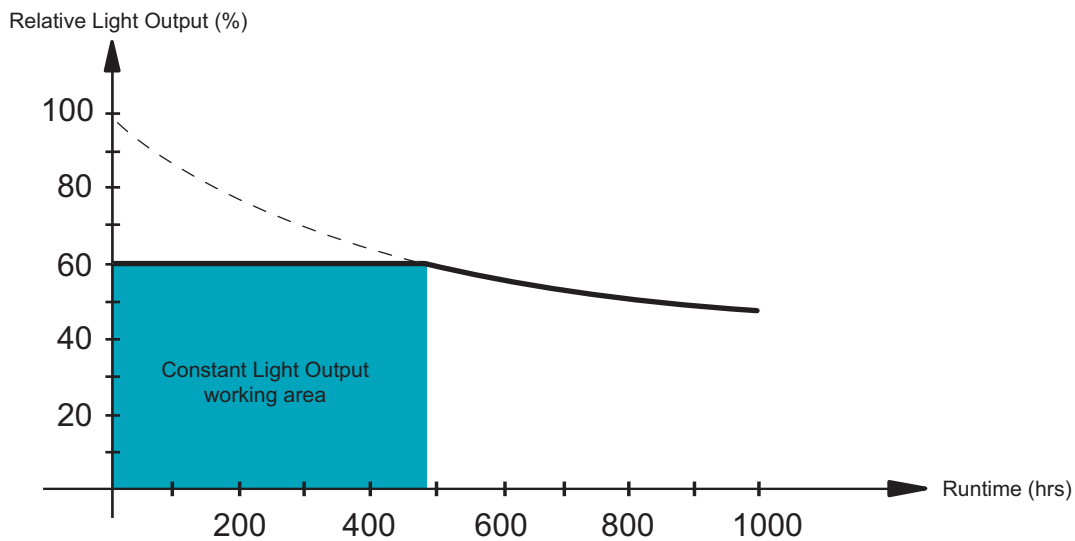


Image 11-17



**CLO mode setting On overrules the lamp power mode setting. Projector will always play in CLO mode using the CLO target.**

### How to switch CLO mode

1. Press **Menu** to activate the menus and select *Lamp* → *Power* → *CLO mode*.

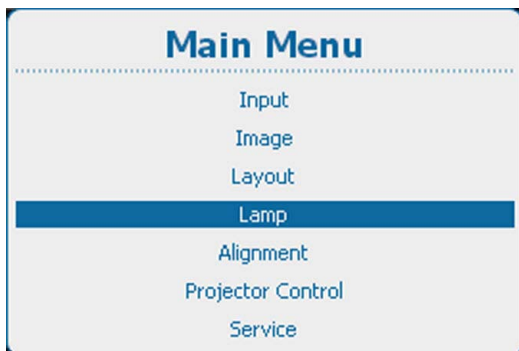


Image 11-18  
Main menu, lamp

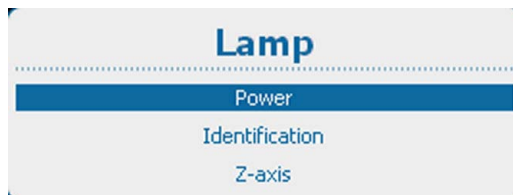


Image 11-19  
Lamp, power

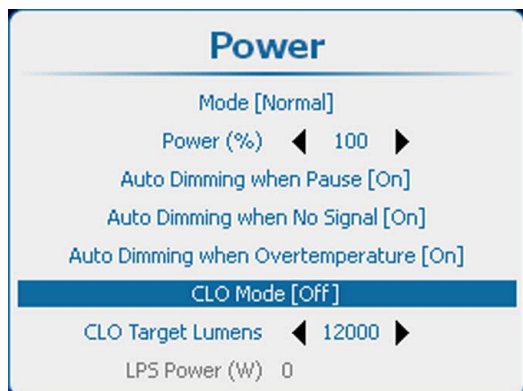


Image 11-20  
Power, CLO mode

2. Press **ENTER** to toggle between [On] or [Off].

## 11.8 CLO targets

### What must be done?

The light output target can be set. This value will force the projector to produce the target lumens when the CLO mode is set to *On*.

### How to set the target

1. Press **Menu** to activate the menus and select *Lamp* → *Power* → *CLO mode*.

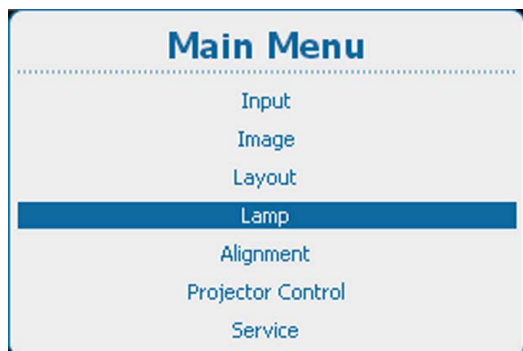


Image 11-21  
Main menu, lamp

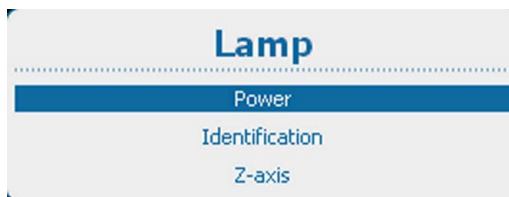


Image 11-22  
Lamp, power

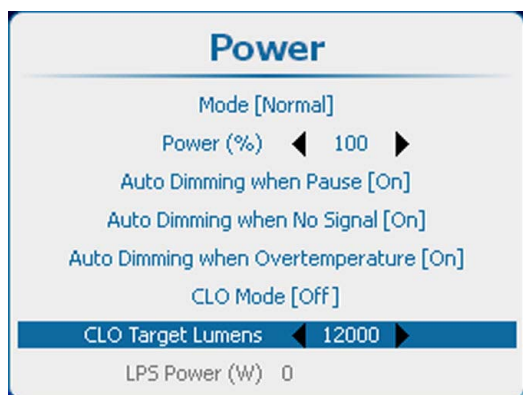


Image 11-23  
CLO Target lumens setup

2. Use the ◀ or ▶ key to change the CLO target lumens.

Depending on the projector model, the value range can be different. The screenshot is only given as information. For the exact values, see the specifications of the specific projector.

## 11.9 LPS power

### What is indicated ?

The current LPS power in watt is indicated as information.

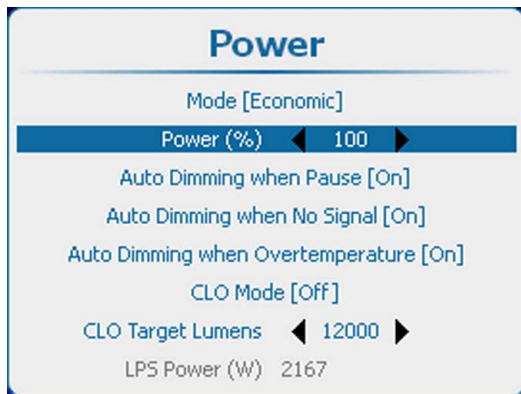


Image 11-24  
LPS power

## 11.10 Lamp identification

### About

The lamp identification menu gives an overview of the most important parameters of the used lamp.

These parameters are:

- Serial number of the lamp
- Article number of the lamp
- Run time since first start up of the lamp
- Remaining run time for a safe operation of the lamp
- Number of strikes since the first start up of the lamp
- Software version



These parameters are useful in case of a service request.

### How to display

1. Press **Menu** to activate the menus and select *Lamp* → *Identification*.

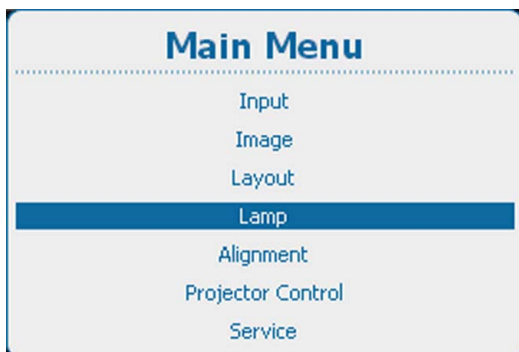


Image 11-25  
Main menu, lamp

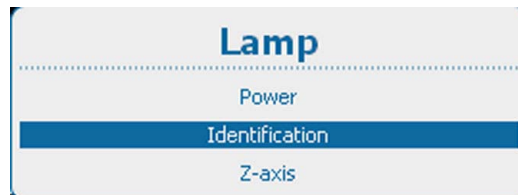


Image 11-26  
Lamp, identification

2. Press **ENTER** to select.





Image 11-27  
Lamp identification

## 11.11 Z-axis adjustment

### What can be done?

The *Z-Axis* menu item gives the current light output of the projector (in percentage). This light output indication can be used to readjust the lamp position in the lamp casing (also called *Z-axis* adjustment of the lamp). With higher run times, the light output of the lamp will decrease, which results in a lower light output on the screen. This light output decrease can be compensated by readjusting the position of the lamp. This realignment has to be done by a qualified service technician.

### How to display the light output

1. Press **Menu** to activate the menus and select *Lamp* → *Z-axis*.

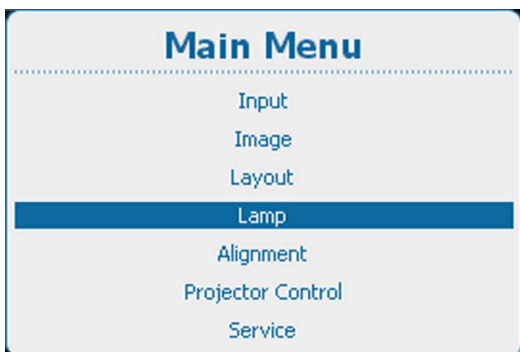


Image 11-28  
Main menu, lamp

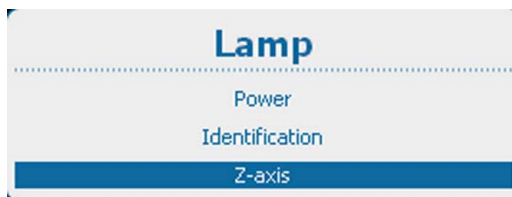


Image 11-29  
Lamp, Z-axis

2. Press **ENTER** to display the current light output.



Image 11-30  
Current light output



## 12. ALIGNMENT

### Overview

- Alignment menu overview
- Orientation
- Lens adjustment, zoom - focus
- Lens adjustment, shift
- Lens adjustment, mid position
- Calbrate lens at startup
- Calibrate lens
- Warping
- Blanking adjustment
- Contrast-Intensity
- Gamma
- Internal patterns
- Color space
- Scenergix
- 3D Glasses
- High End Systems Mirror

### 12.1 Alignment menu overview

#### Overview table

Level 1	Level 2	Level 3
Alignment		
	Orientation	Front / Table Front / Ceiling Rear / Table Rear / Ceiling Auto Front Auto Rear
	Lens	Zoom / Focus Shift Mid Position Calibrate lens at startup Calibrate
	Warping	Status Warp adjust Opacity Warp file service Alternative Side Keystone
	Blanking	Top Bottom Left Right
	Contrast/Intensity	Intensity
	Gamma	
	Internal Patterns	

Color Space	Status Projector EBU SMPTE Custom Custom2
ScenergiX	Status White level Black level ScenergiX pattern Adjust lines Reset
3D Glasses	Dark Time Adjustment Actual Dark Time L/R Output Reference Delay 3D Sync Loop Through
High End Systems Mirror	Projector Controlled Pan / Tilt Store setting per layout

---

## 12.2 Orientation

### What can be done?

The way of physical installation of the projector can be defined to the projector.

The following installation are possible:

- front/table
- front/ceiling
- rear/table
- rear/ceiling
- auto front : automatic front, projector detects itself if it is ceiling or table mounted and projects always a readable image.
- auto rear : automatic rear, projector detects itself if it is ceiling or table mounted and projects always a readable image.

### How to set the correct orientation

1. Press **Menu** to activate the menus and select *Alignment* → *Orientation*.

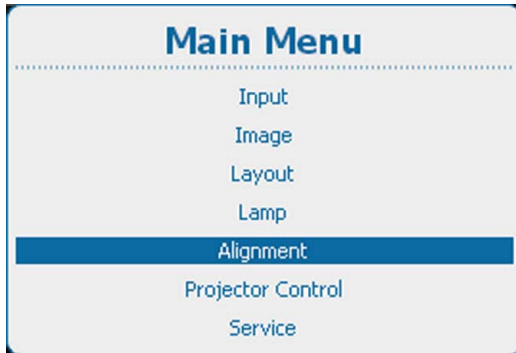


Image 12-1  
Main menu, alignment

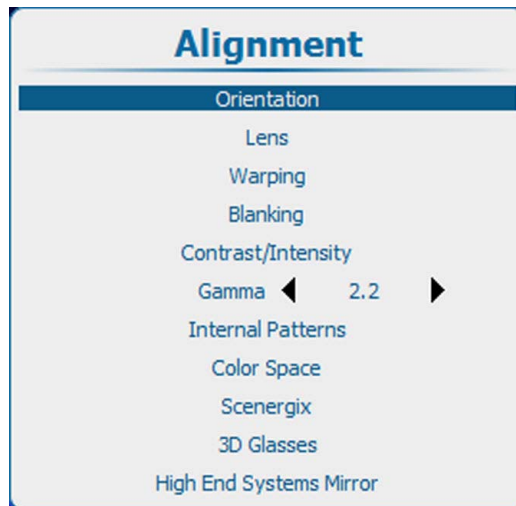


Image 12-2  
Alignment, orientation

- Use the ▲ or ▼ key to select the desired orientation and press **ENTER** to activate.

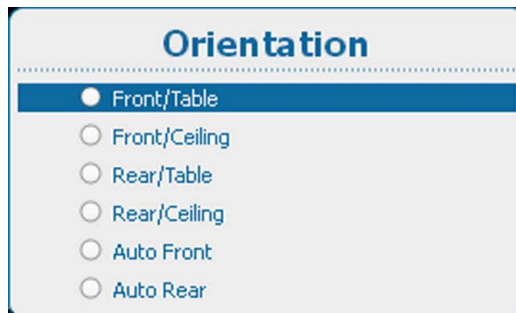


Image 12-3  
Orientation list

## 12.3 Lens adjustment, zoom - focus

### Zoom/Focus adjustment

- Press **Menu** to activate the menus and select *Alignment* → *Lens*.

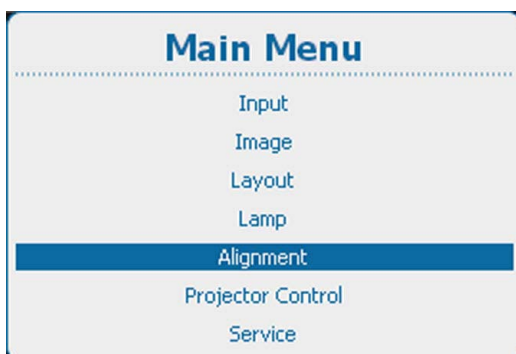


Image 12-4  
Main menu, alignment

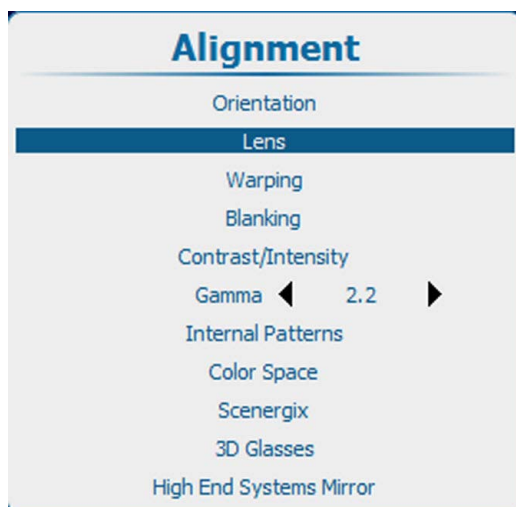


Image 12-5  
Alignment, lens

- Use the ▲ or ▼ key to select *zoom/focus* and press **ENTER** to activate.

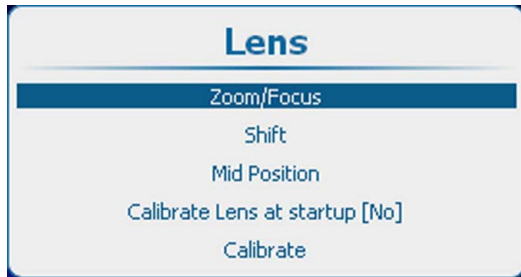


Image 12-6  
Lens, Zoom/Focus

- Use the ▲ or ▼ key to zoom the lens.  
Use the ◀ or ▶ key to focus the lens.  
Press **ENTER** to switch to Lens shift adjustment.

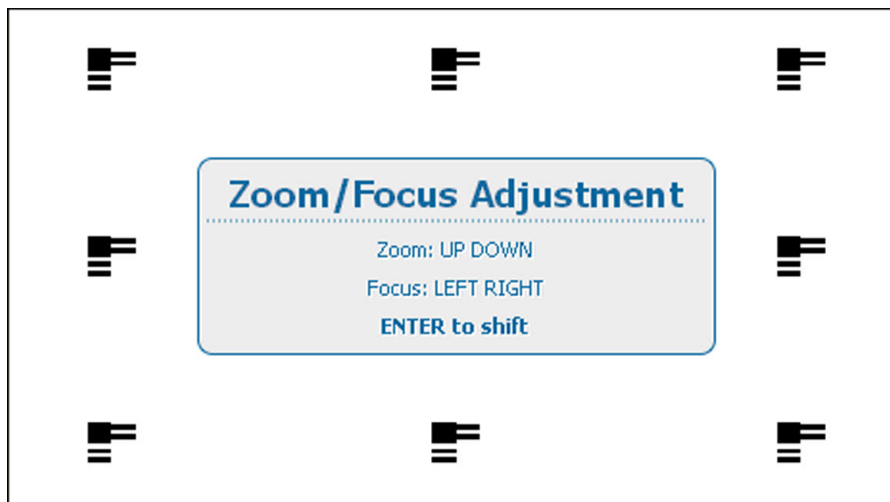


Image 12-7  
Zoom/Focus adjustment

## 12.4 Lens adjustment, shift

### How to shift lens

- Press **Menu** to activate the menus and select *Alignment* → *Lens*.

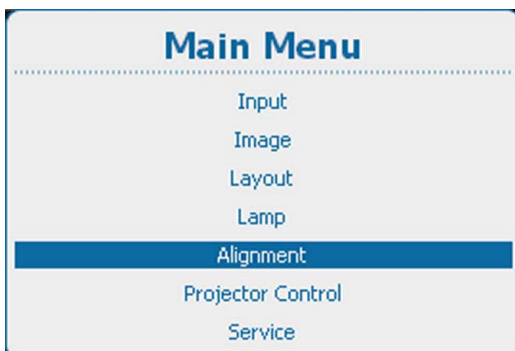


Image 12-8  
Main menu, alignment

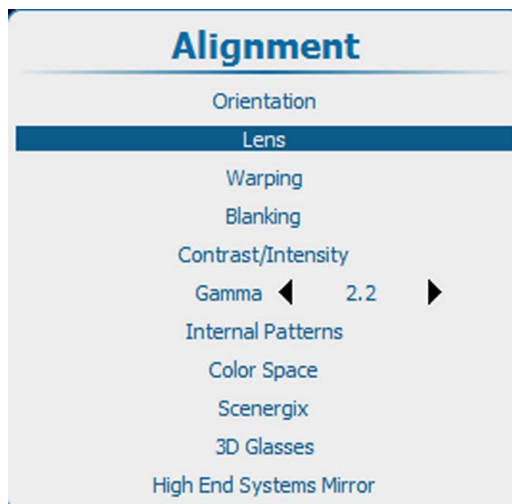


Image 12-9  
Alignment, lens

- Use the ▲ or ▼ key to select *Shift* and press **ENTER** to activate.

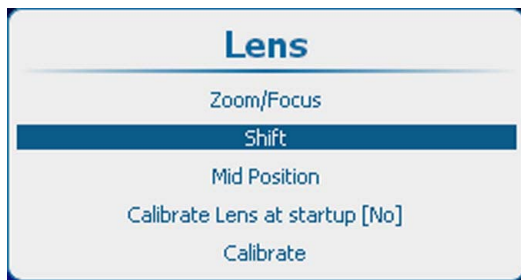


Image 12-10  
Lens, shift

- Use the ▲ or ▼ key to shift the lens in vertical direction.  
Use the ◀ or ▶ key to shift the lens in horizontal direction.  
Press **ENTER** to switch to Zoom/Focus adjustment.

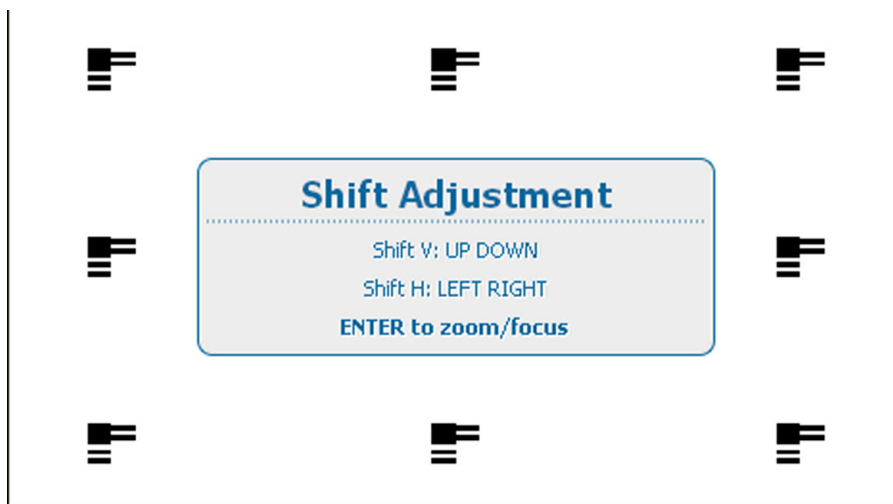


Image 12-11  
Shift adjustment

## 12.5 Lens adjustment, mid position

### How to return to mid position

- Press **Menu** to activate the menus and select *Alignment* → *Lens*.

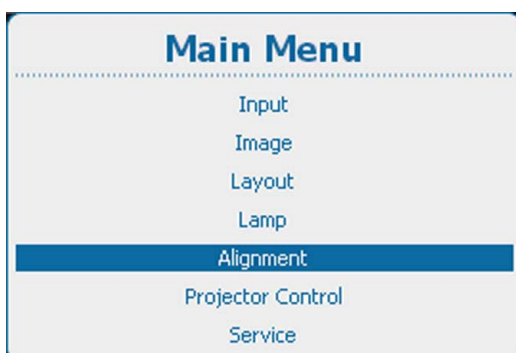


Image 12-12  
Main menu, alignment

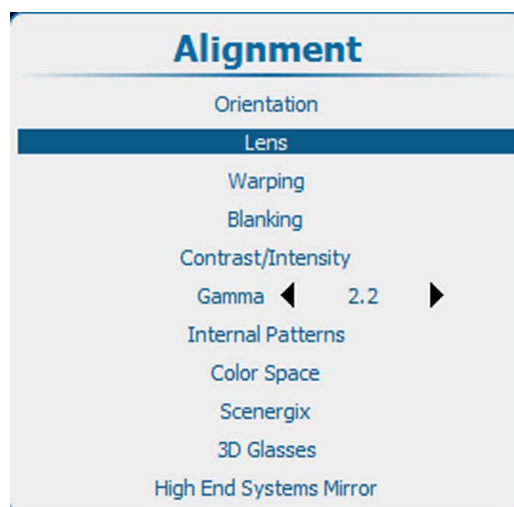


Image 12-13  
Alignment, lens

- Use the ▲ or ▼ key to select *Mid Position* and press **ENTER** to activate.

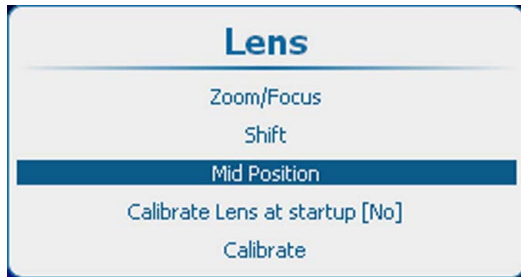


Image 12-14  
Lens, mid position

Lens will be shifted horizontally and vertically to its mid position.

## 12.6 Calbrate lens at startup

### About calibrating lens

Each time the projector is started, a homing procedure (calibration) can be executed so that the projector exactly knows the lens position.

### How to calibrate

1. Press **Menu** to activate the menus and select *Alignment* → *Lens*.

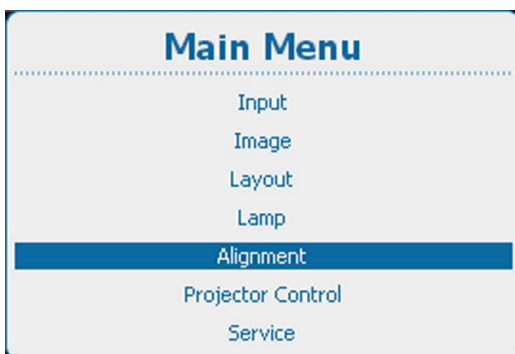


Image 12-15  
Main menu, alignment

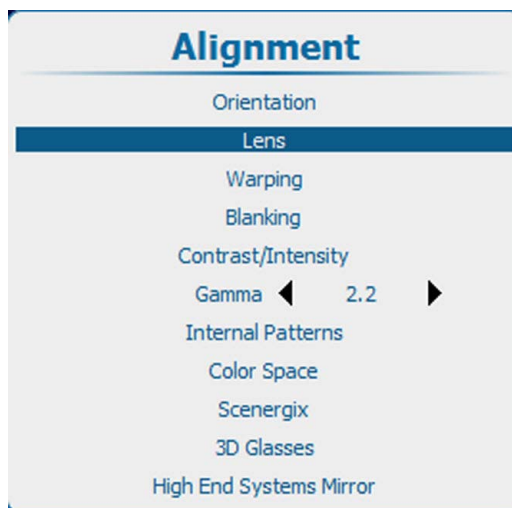


Image 12-16  
Alignment, lens

2. Use the ▲ or ▼ key to select *Calibrate lens at startup* and press **ENTER** to toggle between *[on]* and *[off]*.

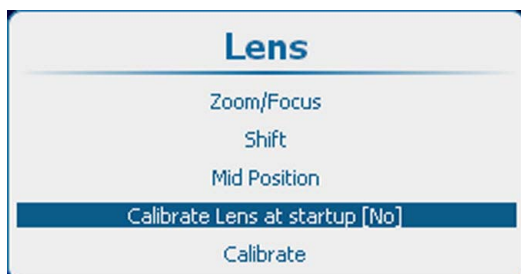


Image 12-17  
Calibrate lens at startup



## 12.7 Calibrate lens



Lens calibration is a time consuming operation.

### How to calibrate

1. Press **Menu** to activate the menus and select *Alignment* → *Lens*.

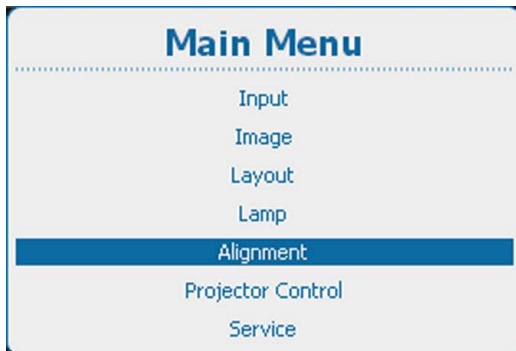


Image 12-18  
Main menu, alignment

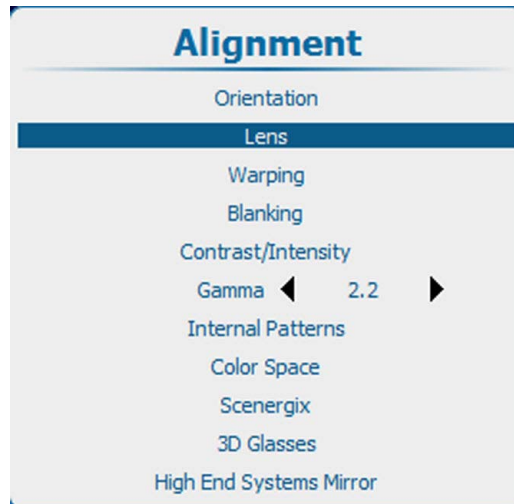


Image 12-19  
Alignment, lens

2. Use the ▲ or ▼ key to select *Calibrate lens* and press **ENTER** to activate.

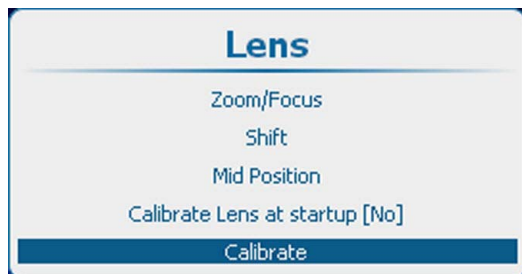


Image 12-20  
Calibrate lens

A Lens Calibration window opens. Select first the desired calibration options by checking the check box before the option and then select Yes to start the calibration procedure.

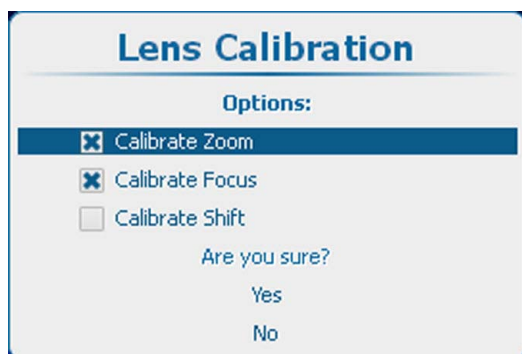


Image 12-21  
Calibrate lens confirmation

---

## 12.8 Warping

---



Not all models are equipped with a warping unit. For these models, the warping unit is optional.

---

### Overview

- About warping
- Warp activation - deactivation
- Start up manual adjustment
- Warp adjustment principle
- Setting the warping level
- Warp adaptation steps
- Making selections and adjustments
- Keystone correction workflow
- Linearity adjustment, workflow
- Selecting and changing the position of a specific point
- Scaling the image
- Shifting the image
- Rotating the image
- Hardware Reset
- OSD opacity
- Warp file service, load file
- Warp file service, save to file
- Warp file service, save as
- Warp file service, rename file
- Warp file service, delete file
- Warp file service, delete all files
- Warp board reset
- Warp board and values reset
- Alternative Side Keystone

### 12.8.1 About warping

#### Overview

Image warping is the process of digitally manipulating an image to compensate for the distortion of the screen. Consequently, it can also be used to generate an image with irregular shape.

While an image can be transformed in various ways, pure warping doesn't affect the colors.

Some examples of warped images, using the warp geometry settings:



Image 12-22  
Example 1 : distorted image

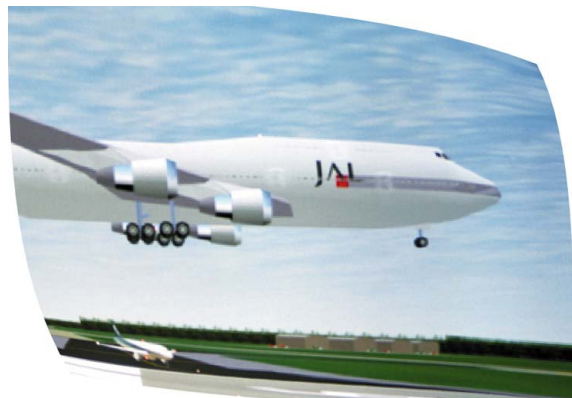


Image 12-23  
Example 2 : distorted image

## 12.8.2 Warp activation - deactivation

### What can be done ?

The Warp functionality can be activated or deactivated.



With 3D activated, warping can be enabled for sources up to 30 Hz per eye. Above this frequency, warping is disabled.

### How to activate - deactivate

1. Press **Menu** to activate the menus and select *Alignment* → *Warping* → *.Warp status*.

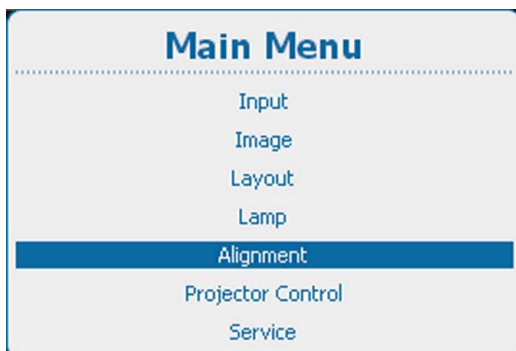


Image 12-24  
Main menu, alignment

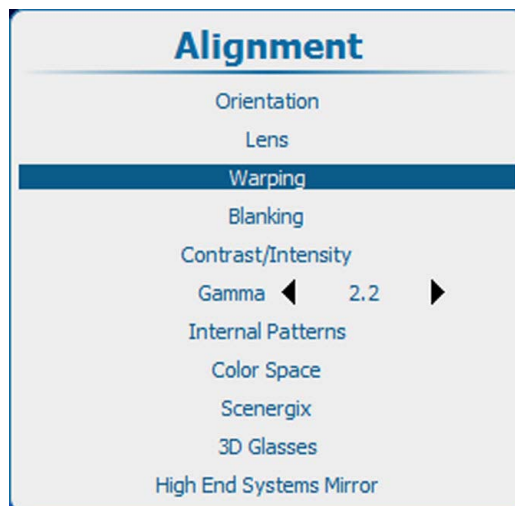


Image 12-25  
Alignment, Warping



Image 12-26  
Warping status

2. Press **ENTER** to toggle between [On] and [Off].

[On]: warp functionality is activated.

[Off]: warp functionality is disabled.

## 12.8.3 Start up manual adjustment

### How to start up

1. Press **Menu** to activate the menus and select *Alignment* → *Warping* → *.Warp adjust*.

## 12. Alignment

The *Warp adjust* menu opens.

The content of this warp adjust menu depends on the selection. When no warp was done before, the menu starts as a sort of wizard by opening only the warp area pane. It opens more and more panes depending on the selection. When manual warping was done before the menu opens with the same layout as it was last used.

A warp grid and adjustment points is displayed on the screen. The maximum grid is 32 points by 32 points.

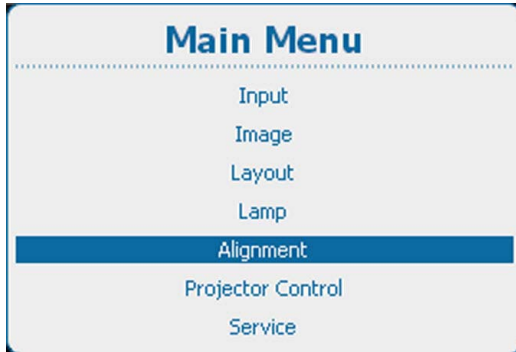


Image 12-27  
Main menu, alignment

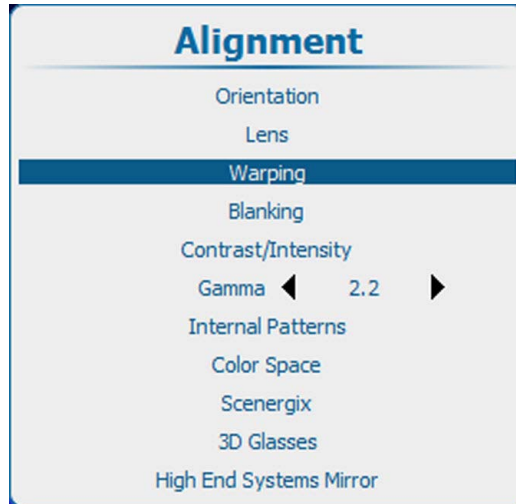


Image 12-28  
Alignment, Warping



Image 12-29  
Warping, Warp adjust



Image 12-30  
Warp area

### Warp adjust menu, general icons

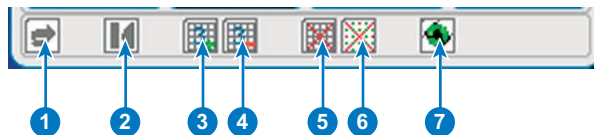


Image 12-31

- 1 Undo / redo icon
- 2 Grid initialization (reset grid to original)
- 3 Increase the number of points. The current number of points (mode) is indicated with a digit inside the icon. By default 3 points are shown.
- 4 Reduce the number of points. The current number of points (mode) is indicated with a digit inside the icon.
- 5 Remove / show grid
- 6 Remove / show points
- 7 Hardware reset of warp module

## 12.8.4 Warp adjustment principle

### Description

Warping adjustment enables the **relocation of pixel groups** in an image in order to introduce spacial distortion. To make the procedure comprehensible, there are some rules and features.



**The use of warping adjustment leads to image quality loss! The more geometry adjustment is applied, the more quality loss.**

Moving an anchor point causes pixels in the same region to be moved gradually with this one pixel, depending on their distance to it. The size of the region of impact depends on the anchor point: some anchor pixels have impact on the full image, while others have impact on a small area only. The full image is divided in **33 x 33 regions**. The smallest region of impact is one of these 1089 regions.

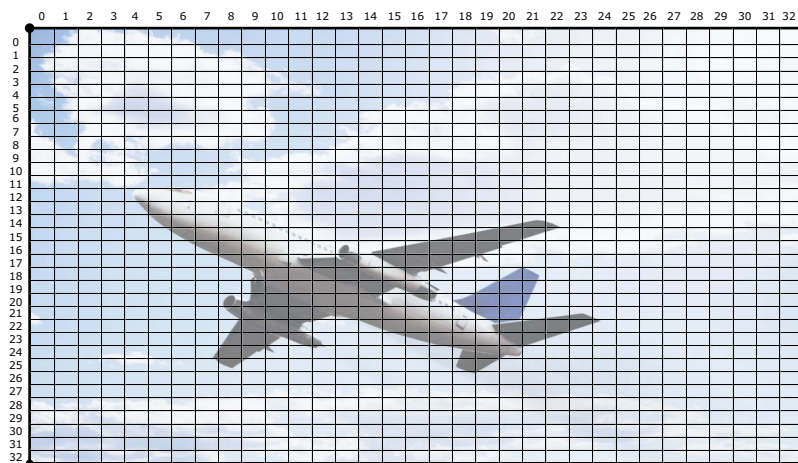


Image 12-32  
33 x 33 regions in an image

Warp adjustment is divided in **six modes**:

- 2 x 2 (highest mode);
- 3 x 3;
- 5 x 5;
- 9 x 9;
- 17 x 17;
- 33 x 33 (lowest mode).

The six modes represent **21 levels**, each level representing its own group of **anchor points**.

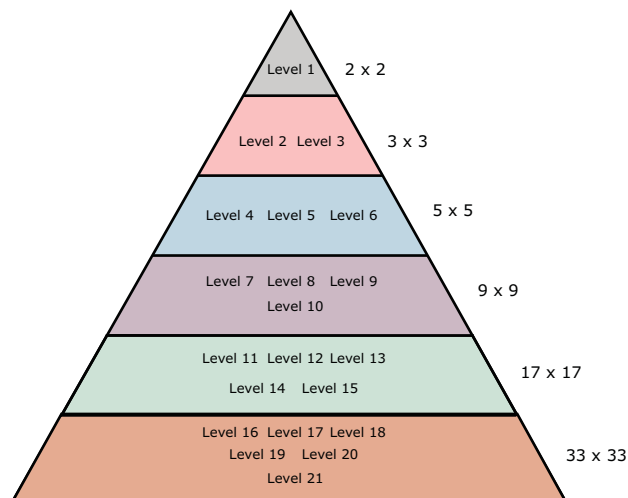


Image 12-33  
Level hierarchy

The **hierarchy** of these levels is very important: each level interacts with all lower levels. Adjusting a point on a certain level affects the points in all or some of the lower levels. The impact depends on the level itself. Therefore it is important to adjust the geometry starting from level one and going down to lower levels as required. In practice it will not be needed to adjust the anchor points of levels 7 and lower.

## 12. Alignment

In 2 x 2 mode, we only have one level, including all four (2 x 2) anchor points, being the image corners. This mode is especially used to correct horizontal and vertical keystone.

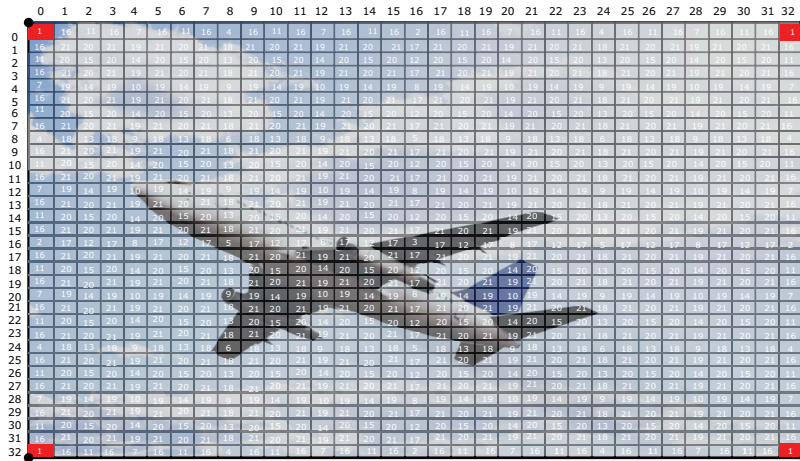


Image 12-34  
Warp adjustment: 2 x 2 mode

In 3 x 3 mode, the image side centers represent the level two anchor points, whereas the image center represents the level three anchor point. Together with the higher level anchor points (level 1, four anchor points), we come to a total of nine (3 x 3) anchor points in this geometry mode. This mode can be used to fine tune the overlap area in multiple channel display systems and to make corrections to meet curved and double curved screens.

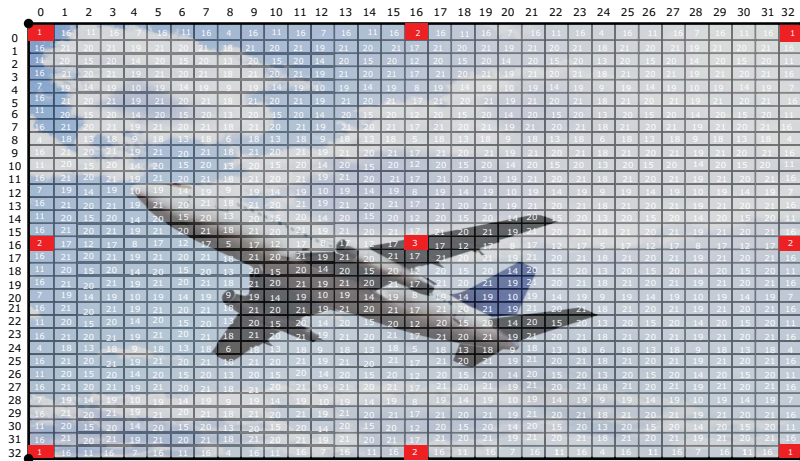


Image 12-35  
Warp adjustment: 3 x 3 mode

In 5 x 5 mode, we add three more levels, being level four (eight anchor points), level five (four anchor points) and level six (four anchor points). So this mode includes 25 (5 x 5) anchor points in total. See the image below.

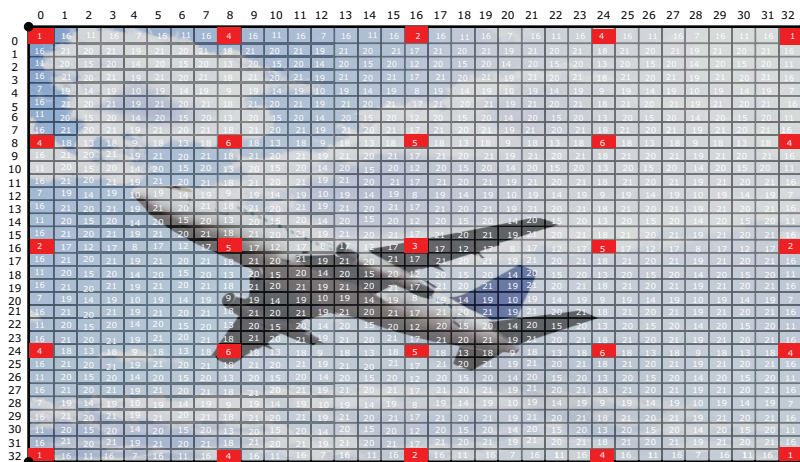


Image 12-36  
Geometry adjustment: 5 x 5 mode

This logic can be extrapolated for the lower modes and levels, being level seven to level 21, however in practice these modes and levels are rarely used.

## 12.8.5 Setting the warping level

### How to select

- With the Warping menu displayed, use the ▲ or ▼ key to select more or less pixels to adjust. Switching between the more or less pixels icon can be done with the ◀ or ▶ key.

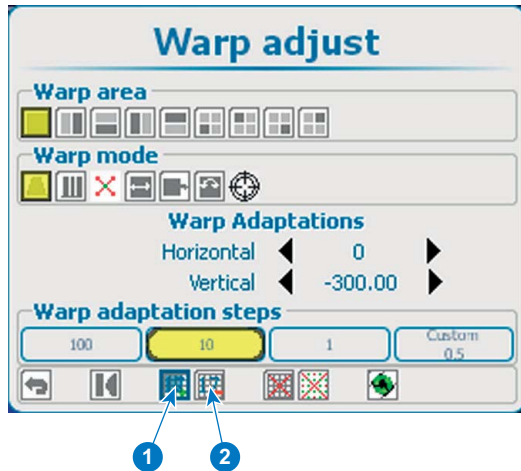


Image 12-37  
Warp level selection

- Increment pixels
- Decrement pixels

The current selected icon shows blue.

- Press **ENTER** to increment or decrement the number of pixels.

The value inside the icon changes accordingly.  
The following selections are possible:

- 2 x 2 (highest level);
- 3 x 3;
- 5 x 5;
- 9 x 9;
- 17 x 17;
- 33 x 33 (lowest level).

## 12.8.6 Warp adaptation steps

### About the steps

An anchor point can be moved with a fixed number of steps: 1, 10 or 100. It is also possible to move an anchor point with custom number of steps or a part of a step.

### How to select a predefined number of steps

- Use the ▲ or ▼ key to go to the Warp adaptation steps area.  
The current selection is indicated in yellow.
- Use the ◀ or ▶ key to select the desired steps.



Image 12-38  
Warp adaptation steps

The following selection is possible:

- 100 pixels
- 10 pixels
- 1 pixel
- Custom

3. Press **ENTER** to accept the selection.

When *Custom* is selected, the step value can be changed.

### How to change the custom step value

1. Use the ▲ or ▼ key to select *Custom steps*.
2. Use the ◀ or ▶ key to change the current value.

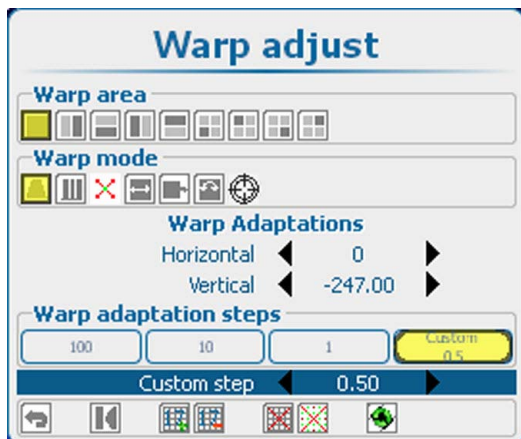


Image 12-39  
Warp adaptation steps, custom

## 12.8.7 Making selections and adjustments

### About a Selection of a function

The current selection is indicated in yellow.

The current position of the cursor is indicated in blue.

The arrow keys are use to move the cursor to a new selection.

### How to make a selection

1. Use the ▲ or ▼ key to select a pane .  
The following panes are available:
  - *Warp area*: full screen, left-right screen, top-bottom screen, one of the four quadrants.
  - *Warp mode*. keystone, horizontal linearity, points, scale, shift, rotation, rotation point.
  - *Warp adaptation*: this pane changes according to the warp mode selection.
2. Within a pane, use the ◀ or ▶ key to select the desired function.
3. Press **ENTER** to activate this function.



4. To adjust a value once selected, use the ◀ or ▶ key to change  
Or,  
press **ENTER** to open a separate adjustment window.  
Use the arrow keys to make the adjustment.



Image 12-40  
Warping, keystone

### About Warp area

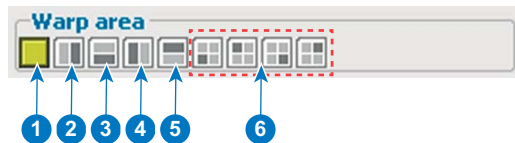


Image 12-41  
Warp area

- 1 Full screen
- 2 Right side
- 3 Bottom side
- 4 Left side
- 5 Top side
- 6 4 quadrants

### About Warp mode

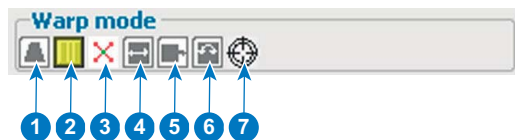


Image 12-42  
Warp mode

- 1 Keystone
- 2 Linearity
- 3 Points
- 4 Scale
- 5 Shift
- 6 Rotate
- 7 Rotation point

## 12.8.8 Keystone correction workflow

### Adjusting vertical and horizontal keystone

1. Select the 2 x 2 adjustment level. See "Setting the warping level", page 171.  
The default selected anchor point is the left top corner of the image.
2. Select the desired warp area.  
Depending on the selected area only the points in that area will be adjusted.
3. Select **keystone**.
4. Select within *Warp Adaptations*, *Horizontal* or *Vertical* to adjust the corresponding keystone.

Or,  
press **ENTER** when an item is selected and use the 4 arrow keys to adjust.



Image 12-43  
Warping, keystone

5. Move the corner points to the desired position.



Image 12-44  
Keystone adjustment

### 12.8.9 Linearity adjustment, workflow

#### Adjusting vertical and horizontal linearity

1. Select the 2 x 2 adjustment level. See "Setting the warping level", page 171.  
The default selected anchor point is the left top corner of the image.
2. Select the desired warp area.  
Depending on the selected area only the points in that area will be adjusted.
3. Select Linearity.
4. Select within *Warp Adaptations*, *Horizontal* or *Vertical* to adjust the corresponding keystone.  
Or,  
press **ENTER** when an item is selected and use the 4 arrow keys to adjust.



Image 12-45  
Warping, Linearity

5. Adjust the horizontal and vertical linearity.  
To fine tune this adjustment, select a specific area and add extra anchor points by changing the warp level.

## 12.8.10 Selecting and changing the position of a specific point

### About point selection

Depending on the warp level, number of selectable points, a specific point can be selected and moved in any direction. The coordinate system works with 33 x 33 pixels (0 to 32). Depending on the warp level the cursor will jump from active point to active point.

E.g. for 5 x 5 the first point has coordinates (0,0), the second point in horizontal direction will have coordinates (12,0), etc. .

### How to select a point

1. Select the warp level (1).

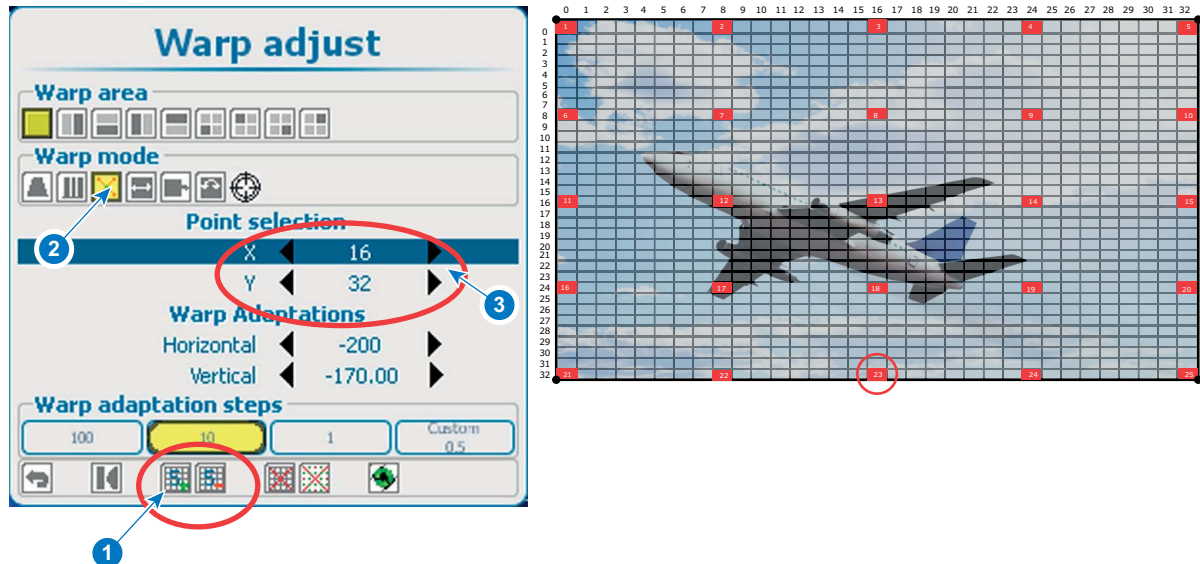


Image 12-46  
Point selection

2. Select Warp mode points (2).
3. Use the ▲ or ▼ key to go to Point selection.
4. Select alternating the X and Y coordinate and change the value (3).  
Or,  
press **ENTER** to open the point selection window.  
Use the 4 arrow keys to select the desired point.  
Press **ENTER** to the Warping adaptations.

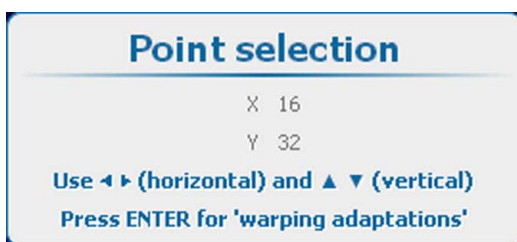


Image 12-47  
Point selection



Image 12-48  
Moving selected point

5. Use the 4 arrow keys to change the position of the selected point.

## 12.8.11 Scaling the image

### About scaling

It is possible to scale the whole image. This is considered as an equal scale of the 4 corner points in 2 x 2 mode. The Warping adaptation window is used to scale the image.

### How to scale

1. Select the 2 x 2 adjustment level. See "Setting the warping level", page 171.

The default selected anchor point is the left top corner of the image.

2. Select the desired warp area.

Depending on the selected area only the points in that area will be adjusted and the scale direction changes according the selection.

3. Select **Scale**.
4. Select within *Warp Adaptations*, an available adjustment to scale the image.  
Or,  
press **ENTER** when an item is selected and use the 4 arrow keys to adjust.



Image 12-49  
Warping, scaling

### 12.8.12 Shifting the image

#### About shifting

It is possible to shift the whole image. This is considered as an equal movement of the 4 corner points in 2 x 2 mode. The Warping adaptation window is used for adjusting the shift. After shifting the image parts of the image might not be visible anymore.

#### How to shift

1. Select the 2 x 2 adjustment level. See "Setting the warping level", page 171.  
The default selected anchor point is the left top corner of the image.
2. Select the desired warp area.  
Depending on the selected area only the points in that area will be adjusted and the shift direction changes according the selection.
3. Select **Shift**.
4. Select within *Warp Adaptations*, an available adjustment to shift the image.  
Or,  
press **ENTER** when an item is selected and use the 4 arrow keys to adjust.



Image 12-50  
Warping, shifting

### 12.8.13 Rotating the image

#### About rotating

The image can be rotated around a predefined point. This is considered as an equal rotation of the 4 corner points in 2 x 2 mode and with the full area selected. The default rotation point is the center of the image.



Image 12-51  
Rotation

### Selecting rotation point

1. Select full image as warp area (1).

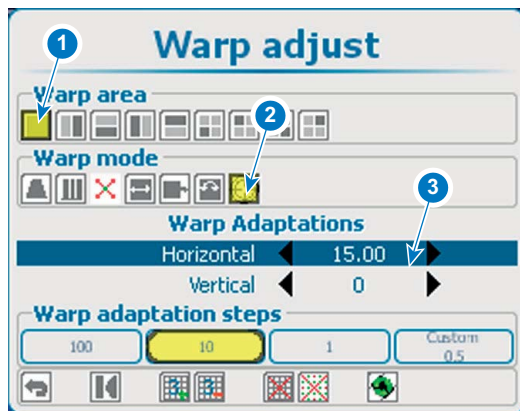


Image 12-52  
Rotation point, selection

2. Use the arrow keys to select Rotation point (2).
3. Select Warp Adaptations and use the arrow keys to move rotation point to the desired position (3).  
Or,  
press **ENTER** when an item is selected and use the 4 arrow keys to adjust.



Image 12-53  
Warping, scaling

4. Continue with the rotation.

### Rotate around the rotation point

1. Select the 2 x 2 adjustment level. See "Setting the warping level", page 171.
2. Select full image as warp area.

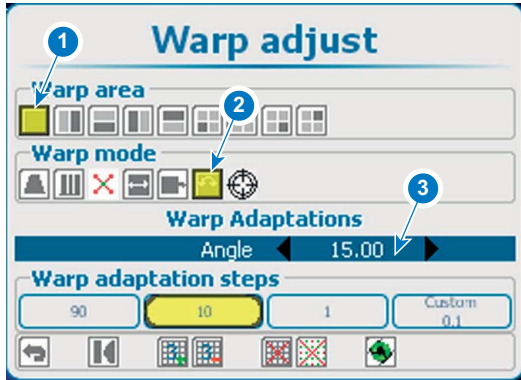


Image 12-54  
Rotate image

3. Select Warp adaptation, angle.
4. Use the ◀ or ▶ key to change the rotation *Angle*.  
Or,  
press **ENTER** to open the Warping Adaptations window. Use the ◀ or ▶ key to change the Angle.



Image 12-55  
Warping adaptation, angle

### 12.8.14 Hardware Reset

#### What can be done ?

During some combinations of adjustments, it is possible that the warping get stuck. Than it is possible to reset the board and restart from a clean adjustment.

#### How to reset

1. Use the arrow keys to select the **Reset** icon on the general icon bar at the bottom of the *Warp adjust* window.

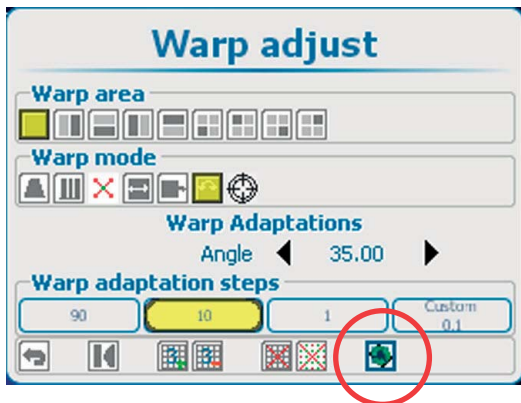


Image 12-56  
Hardware reset

The hardware will restart. It can take a while until the warp unit is available again.

### 12.8.15 OSD opacity

#### About the opacity of the OSD menus

During the warp adjustment process the OSD menu is displayed on top the warp grid. To see the grid and the grid points, reduce the opacity of the OSD menu.

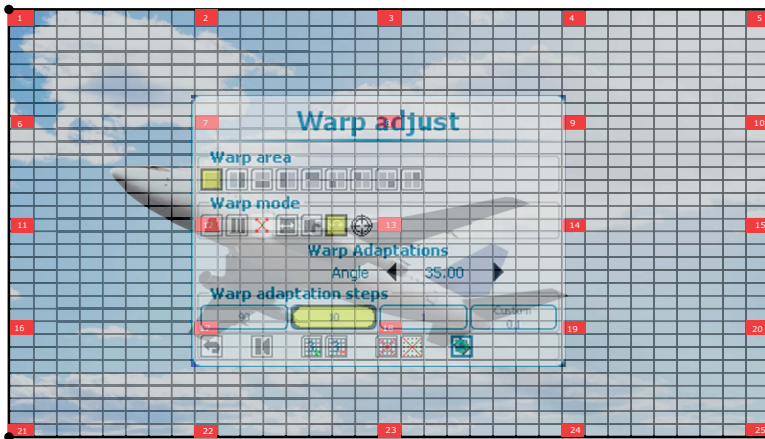


Image 12-57  
Opacity

### How to adjust

1. Press **Menu** to activate the menus and select *Alignment* → *Warping* → *.Opacity*.

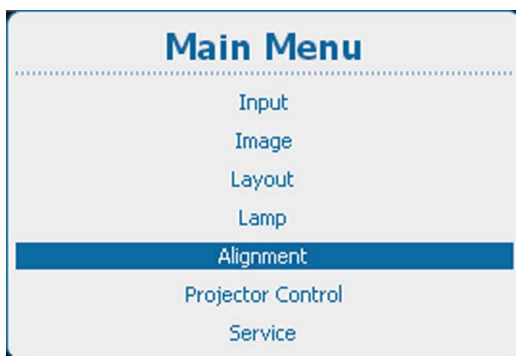


Image 12-58  
Main menu, alignment

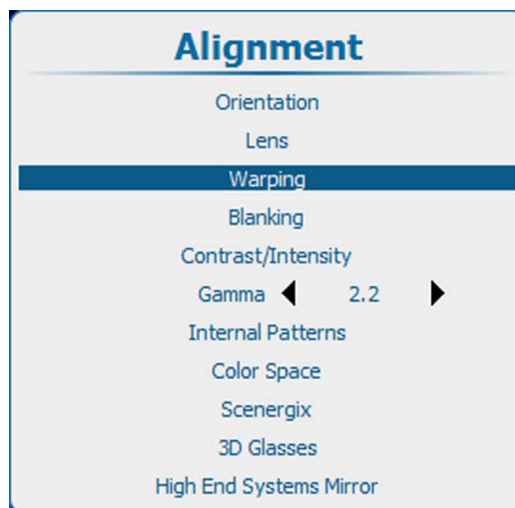


Image 12-59  
Alignment, Warping

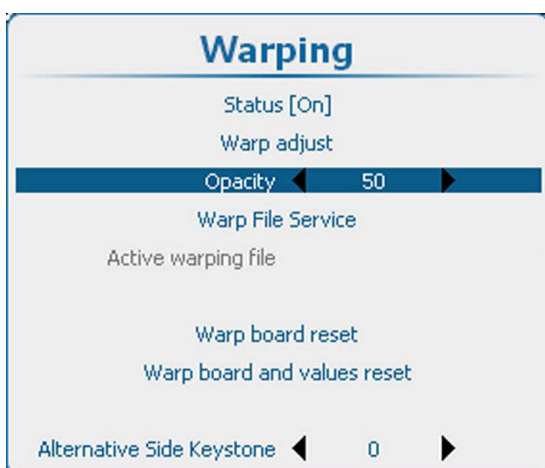


Image 12-60  
Warping, opacity

2. Use the ◀ or ▶ key to change the opacity.

### 12.8.16 Warp file service, load file

#### What can be done?

A predefined warp configuration can be loaded in the warp board as active warp configuration file.



To exclude the warp functionality, load the file *NoDistortion.txt*.

#### How to load

1. Press **Menu** to activate the menus and select *Alignment* → *Warping* → *Warp File Service* → *.Load*.

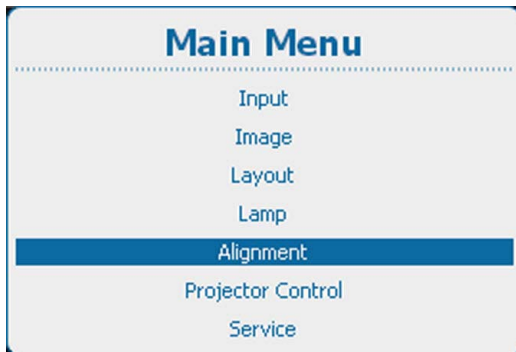


Image 12-61  
Main menu, alignment

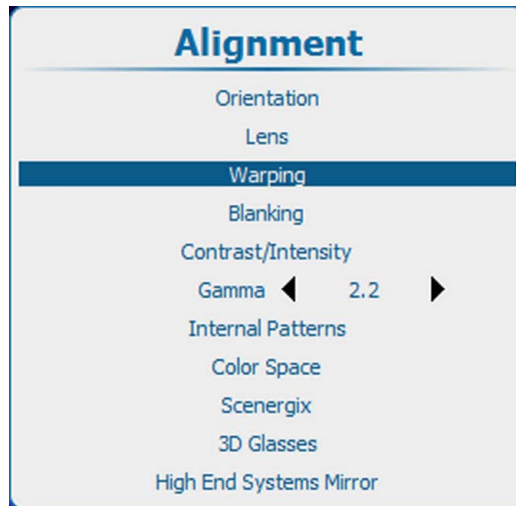


Image 12-62  
Alignment, Warping



Image 12-63  
Warping, file service



Image 12-64  
File service, load

2. Press **ENTER** to display the overview list with warp files.

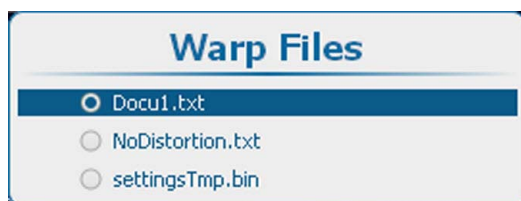


Image 12-65  
Warp files

3. Use the **▲** or **▼** key to select the desired file.



### 12.8.17 Warp file service, save to file

#### What can be done?

The current warp settings are saved in the current active file

#### How to save

1. Press **Menu** to activate the menus and select *Alignment* → *Warping* → *.Warp File Service* → *.Save*.

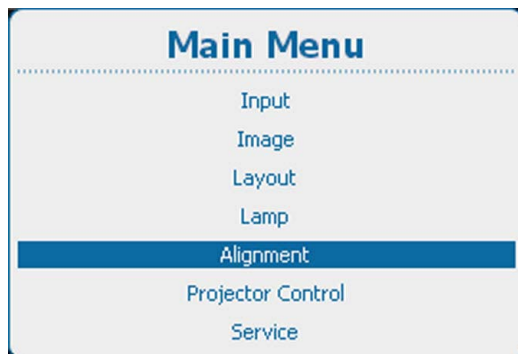


Image 12-66  
Main menu, alignment

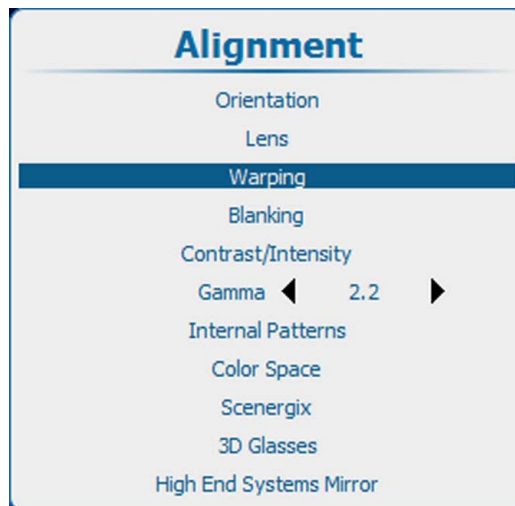


Image 12-67  
Alignment, Warping

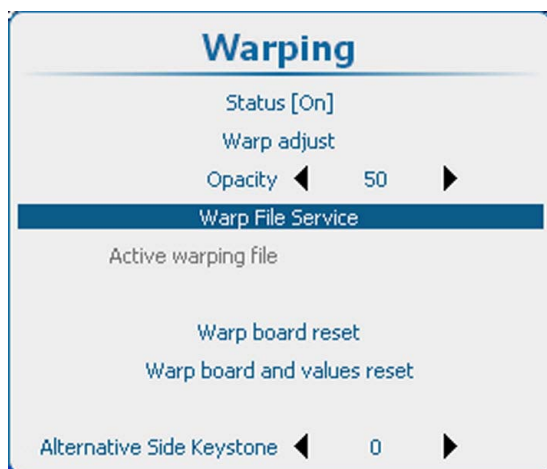


Image 12-68  
Warping, file service



Image 12-69  
Save to file

2. Press **ENTER** to save the settings.

### 12.8.18 Warp file service, save as

#### What can be done?

The current settings can be saved into a new file.

#### How to save

1. Press **Menu** to activate the menus and select *Alignment* → *Warping* → *.Warp File Service* → *.Save as*.

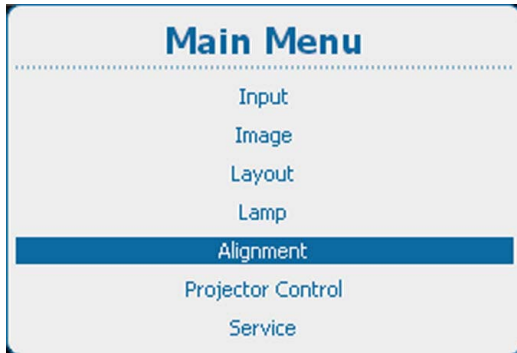


Image 12-70  
Main menu, alignment

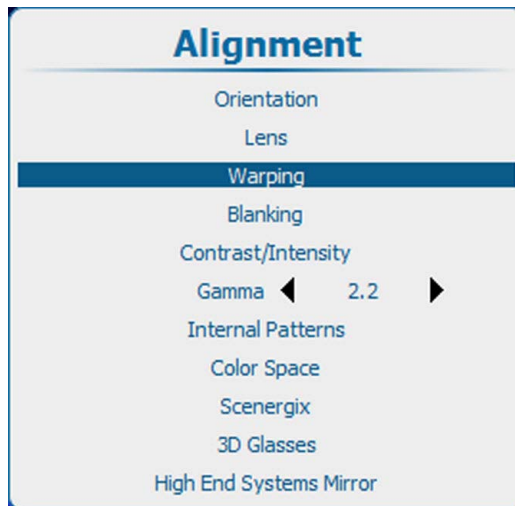


Image 12-71  
Alignment, Warping



Image 12-72  
Warping, file service



Image 12-73  
Save as

2. Press **ENTER** to open the *Enter the name* window.  
The current active file name is displayed.
3. Use the **▲** or **▼** key to change the selected character.  
Use the **◀** or **▶** key to select another character.

**Note:** *Digits can be entered with the digit keys on the remote control or the local keypad. When a digit is entered in that way, the next character will be selected automatically. Arrow key left (◀) has the backspace functionality.*

4. Press **ENTER** to finalize the save as action.

### 12.8.19 Warp file service, rename file

#### How to rename?

1. Press **Menu** to activate the menus and select *Alignment* → *Warping* → *.Warp File Service* → *.Rename*.

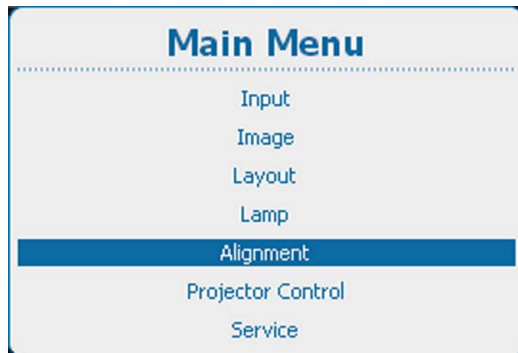


Image 12-74  
Main menu, alignment

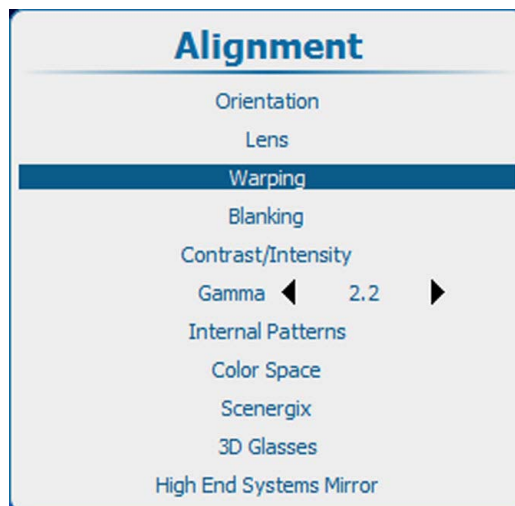


Image 12-75  
Alignment, Warping



Image 12-76  
Warping, file service



Image 12-77  
Rename warp file



Image 12-78  
Warp files

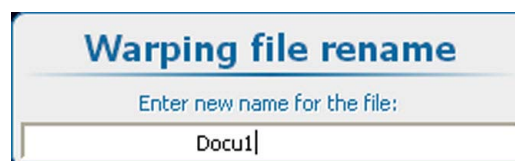


Image 12-79  
Rename file

2. Press **ENTER** to display the list of warp files.
3. Use the **▲** or **▼** key to select the file to rename. and press **ENTER**.
4. Use the **▲** or **▼** key to change the selected character.  
Use the **◀** or **▶** key to select another character.  
**Note:** Digits can be entered with the digit keys on the remote control or the local keypad. When a digit is entered in that way, the next character will be selected automatically. Arrow key left (**◀**) has the backspace functionality.
5. Press **ENTER** to finalize the rename action.

### 12.8.20 Warp file service, delete file

#### How to delete

1. Press **Menu** to activate the menus and select *Alignment* → *Warping* → *.Warp File Service* → *.Delete*.

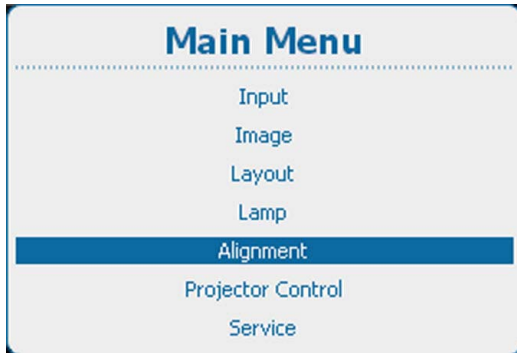


Image 12-80  
Main menu, alignment

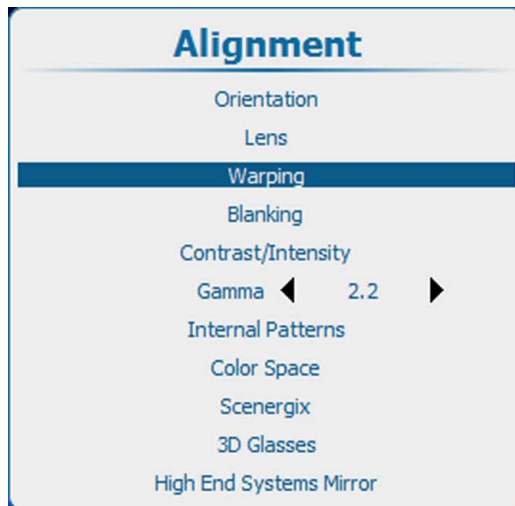


Image 12-81  
Alignment, Warping



Image 12-82  
Warping, file service

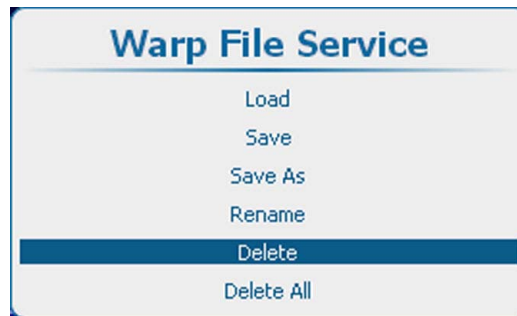


Image 12-83  
Delete warp file

2. Press **ENTER** to display the Warp file list.



Image 12-84  
Warp files

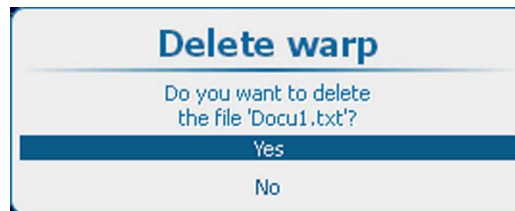


Image 12-85  
Confirm delete

3. Use the **▲** or **▼** key to select the file to delete and press **ENTER**.

4. Use the **▲** or **▼** key to Yes or No and press **ENTER**.

Yes: file will be deleted.

No: file remains in list.

### 12.8.21 Warp file service, delete all files

#### What can be done?

All custom created warp files can be deleted.

#### How to delete

1. Press **Menu** to activate the menus and select *Alignment* → *Warping* → *.Warp File Service* → *.Delete All*.

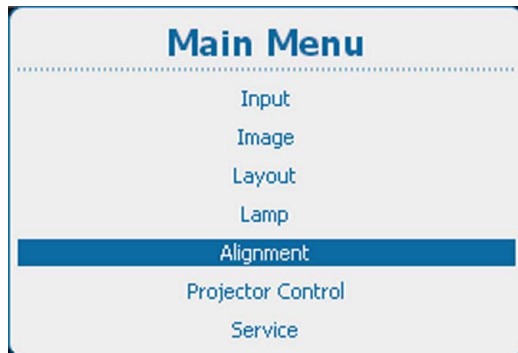


Image 12-86  
Main menu, alignment

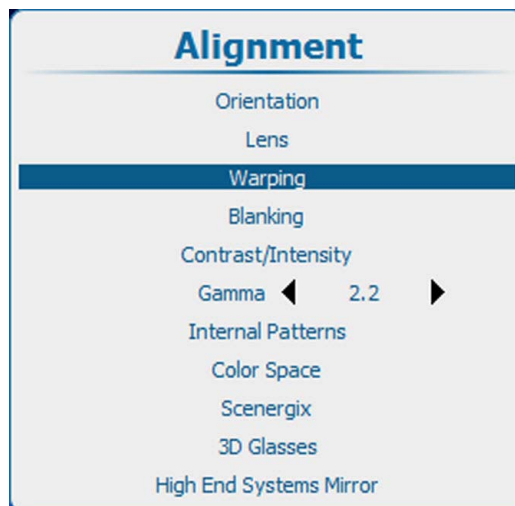


Image 12-87  
Alignment, Warping



Image 12-88  
Warping, file service



Image 12-89  
Delete all

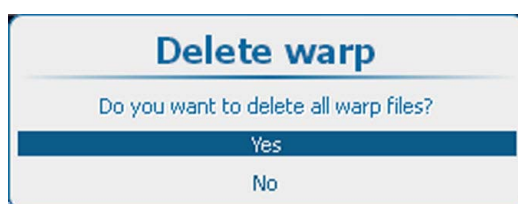


Image 12-90  
Confirm delete

2. Press **ENTER**.
3. Use the **▲** or **▼** key to Yes or No and press **ENTER**.
  - Yes: files will be deleted.
  - No: no files deleted

### 12.8.22 Warp board reset

#### What can be done?

In some circumstances the hardware of the warping get stuck. A hard reset of the board is the only solution. With Warp board reset, the board is reset but the current values remain in the board.

#### How to reset the board

1. Press **Menu** to activate the menus and select *Alignment* → *Warping* → *.Warp board reset*.

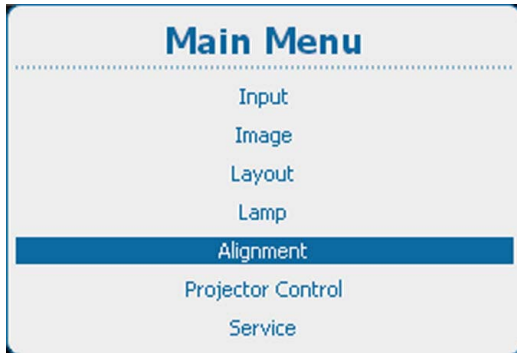


Image 12-91  
Main menu, alignment

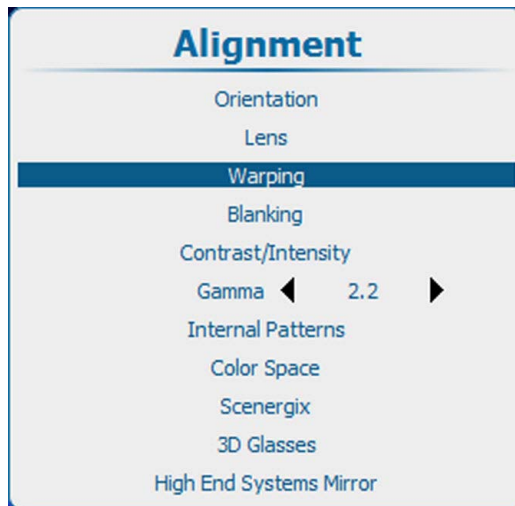


Image 12-92  
Alignment, Warping



Image 12-93  
Warp board reset

2. Press **ENTER** to start the board reset.

### 12.8.23 Warp board and values reset

#### What can be done?

With some extreme warp values the hardware of the warping can get stuck. With only a hard reset of the board, it starts up with the same extreme values and get stuck immediately. So that is not the solution. Therefore, while executing a hard reset, the warp values are reset at the same time so that the board can start up.

#### How to reset board and values

1. Press **Menu** to activate the menus and select *Alignment* → *Warping* → *Warp board and values reset*.

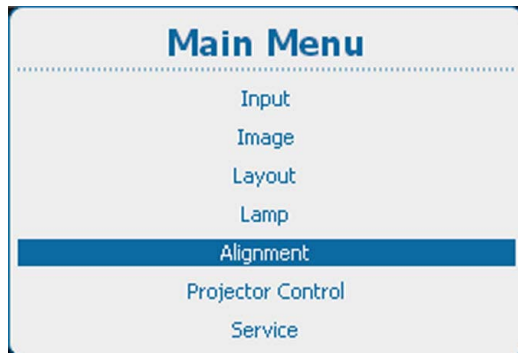


Image 12-94  
Main menu, alignment

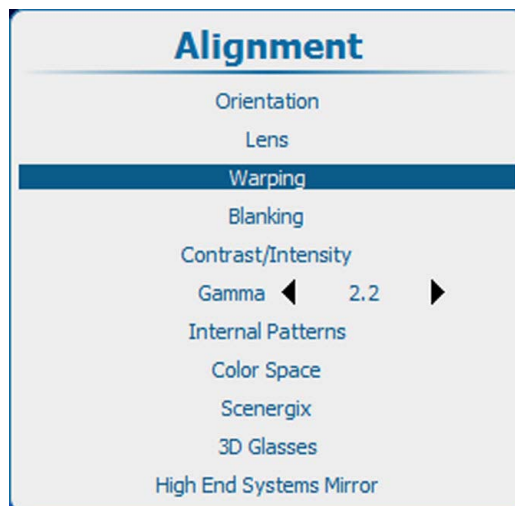


Image 12-95  
Alignment, Warping



Image 12-96  
Warp board and values reset

2. Press **ENTER** to reset the board and the current warp values.

### 12.8.24 Alternative Side Keystone

#### About the alternative side keystone

For 3D sources with a frequency higher than 30 Hz/eye, the warp unit cannot be used anymore. Therefore, for these source the alternative side keystone can be used.

#### How to adjust

1. Press **Menu** to activate the menus and select *Alignment* → *Warping* → *Alternative Side Keystone*.

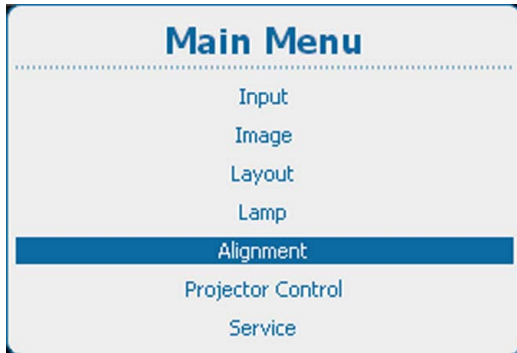


Image 12-97  
Main menu, alignment

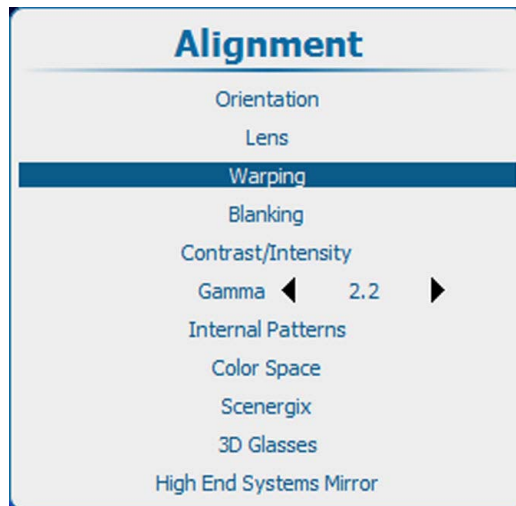


Image 12-98  
Alignment, Warping



Image 12-99  
Alternative side keystone

2. Use the ▲ or ▼ key to adjust the keystone.

## 12.9 Blanking adjustment

---

### What can be done ?

Blanking adjustments affect only the edges of the projected image and are used to frame the projected image on to the screen and to hide or black out unwanted information (or noise). A '0' on the bar scale indicates no blanking.

### Which blanking adjustments are available ?

- top blanking
- bottom blanking
- left blanking
- right blanking



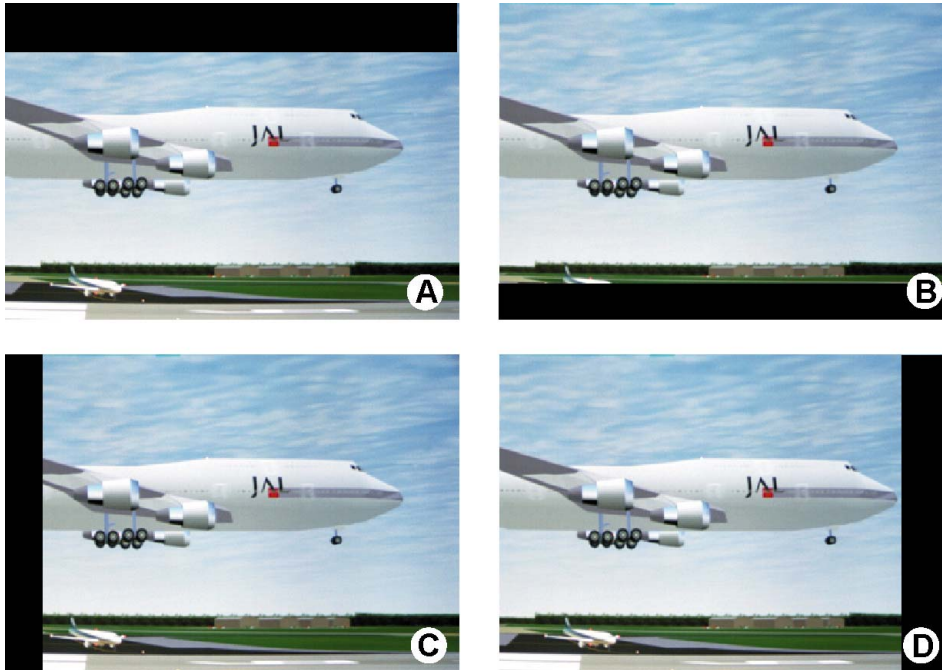


Image 12-100  
Blanking

- A Top blanking
- B Bottom blanking
- C Left blanking
- D Right blanking

The reset function brings all blanking settings back to zero.

### How to adjust

1. Press **Menu** to activate the menus and select *Alignment* → *Blanking*.

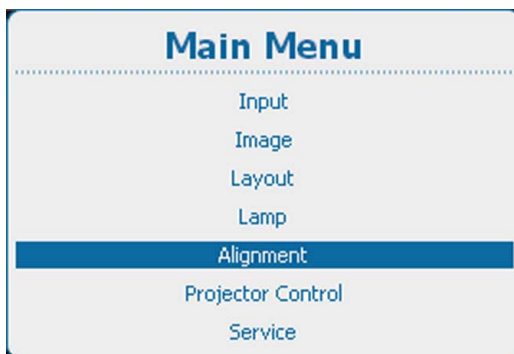


Image 12-101  
Main menu, alignment

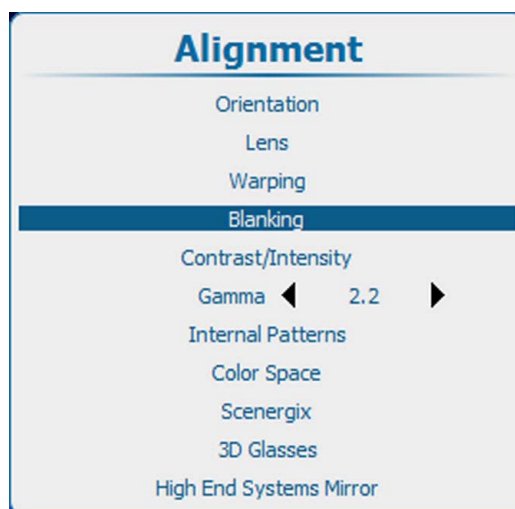


Image 12-102  
Alignment, blanking

2. Press **ENTER** to select.

The blanking adjustment menu opens.



Image 12-103  
Blanking adjustment

- Use the ▲ or ▼ key to select the desired blanking adjustment and adjust with the ◀ or ▶ key.



Select **Reset** to reset all blanking adjustments.

## 12.10 Contrast-Intensity

### Purpose

Contrast : change the contrast of the complete output signal (main and PiP window together) of the projected image.

Intensity : change the brightness of the complete output signal (main and PiP window together) of the projected image.

### How to set up

- Press **Menu** to activate the menus and select *Alignment* → *Contrast/Intensity*.

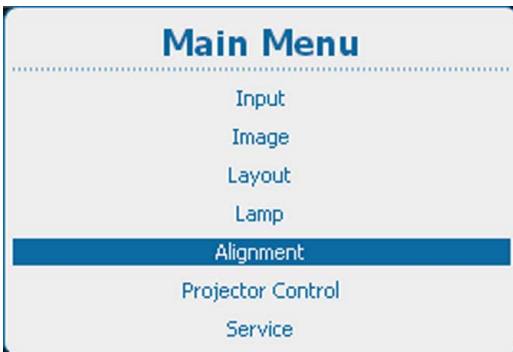


Image 12-104  
Main menu, alignment

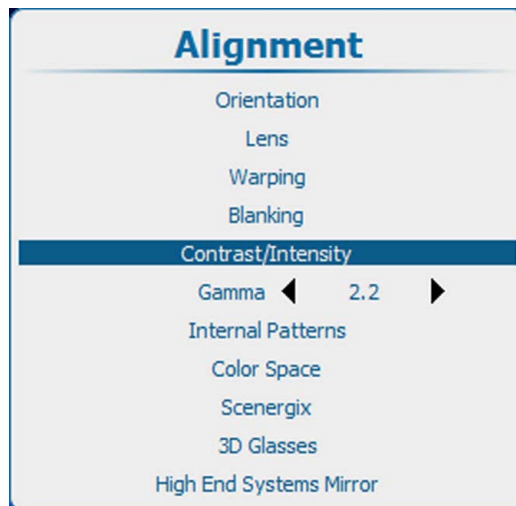


Image 12-105  
Alignment, contrast/intensity

- Press **ENTER** to select.



Image 12-106  
Contrast enhancement

- Use the ▲ or ▼ key to select *Contrast Enhancement*.  
Use the ◀ or ▶ key to change the contrast enhancement until the desired value is reached (adjustable between 0 and 5)
- Use the ▲ or ▼ key to select *Intensity*.

Use the ◀ or ▶ key to change the intensity until the desired value is reached (adjustable between 0 and 255)



Image 12-107  
Intensity

## 12.11 Gamma

### About Gamma

Gamma is an image quality enhancement function that offers a richer image by brightening the already darker portions of the image without altering the brightness of the brighter portions (contrast feeling enhanced).

### How to adjust

1. Press **Menu** to activate the menus and select *Alignment* → *Gamma*.

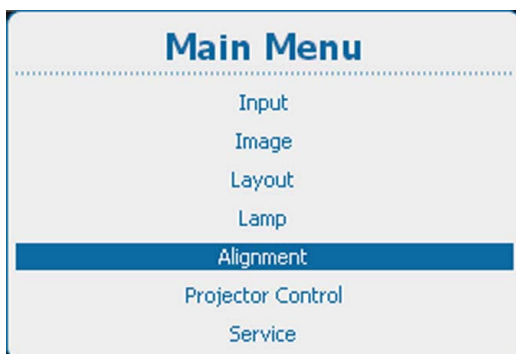


Image 12-108  
Main menu, alignment

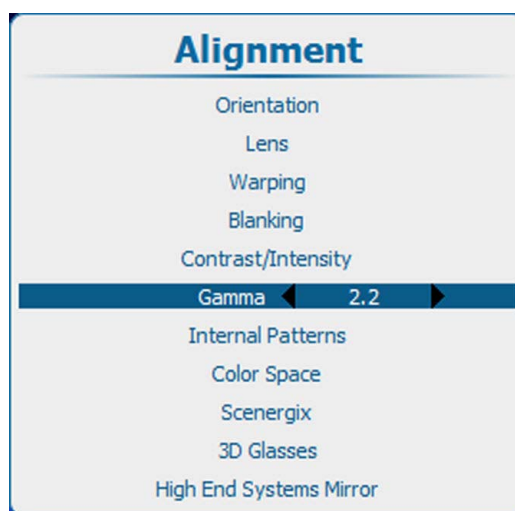


Image 12-109  
Alignment, gamma

2. Use the ◀ or ▶ key to change the gamma value between 1.0 and 3.1 .

## 12.12 Internal patterns

### What can be done with these patterns?

The projector is equipped with different internal patterns which can be used for measurement and alignment purposes.

### How to select a pattern

1. Press **Menu** to activate the menus and select *Alignment* → *Internal Patterns*.

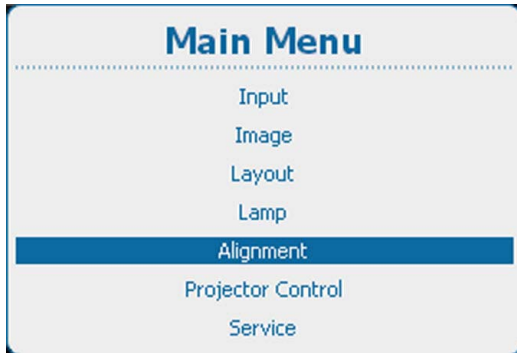


Image 12-110  
Main menu, alignment

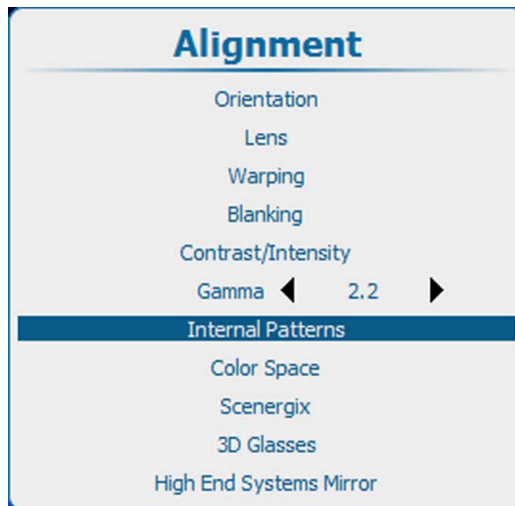


Image 12-111  
Alignment, internal patterns

2. Press **ENTER** to select the pattern list.

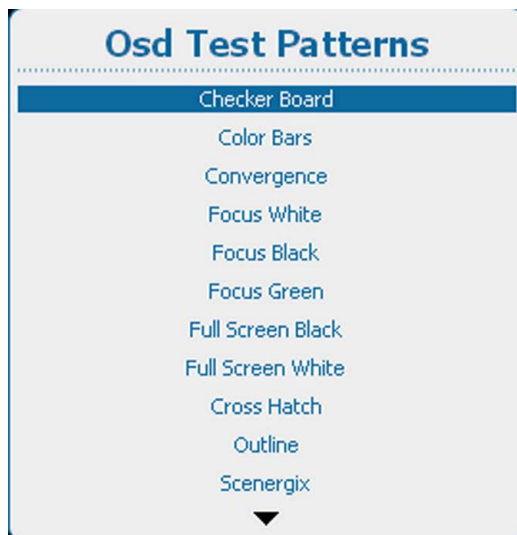


Image 12-112  
OSD test patterns

3. Use the **▲** or **▼** key to select a pattern and press **ENTER** to display that pattern.

The following patterns are available:

- Checker board
- Color Bars
- Convergence
- Convergence\_2
- Ansi Lumen
- Focus white
- Focus black
- Focus green
- Full Screen Black
- Full Screen White
- Cross Hatch
- Outline
- Scenergix

## 12.13 Color space



### Color space

A color space or color standard is a mathematical representation for a color. For example the RGB color space is based on a Cartesian coordinate system.

### What can be adjusted ?

The color space (gamut), the collection of colors which can be reproduced by the projector, can be adjusted to 4 predefined stored values (one projector specific, 2 international standards and one custom preset). A temporary custom adjustment is possible. The maximum color space which can be displayed is the projector color space. This color space is measured at the factory and stored inside the projector.

### How to select a color standard

1. Press **Menu** to activate the menus and select *Alignment* → *Color Space*.

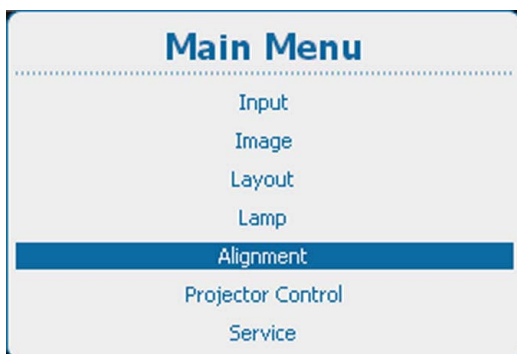


Image 12-113  
Main menu, alignment

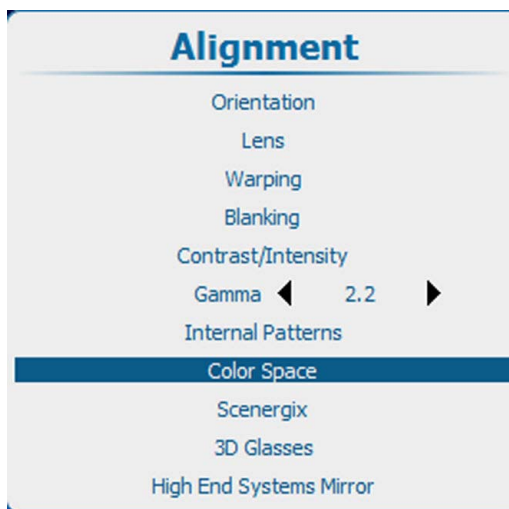


Image 12-114  
Alignment, color space

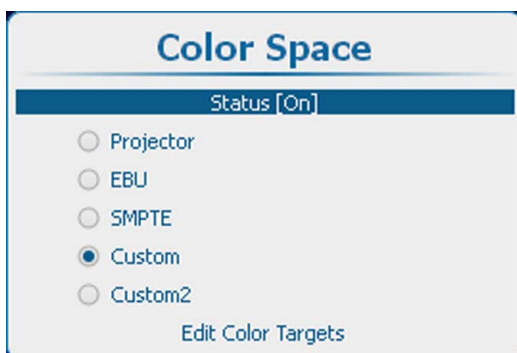


Image 12-115  
Color space

2. Select *Status* and press **ENTER** to toggle between *[On]* or *[Off]*.
  - [On] : projector will use the selected color space.
  - [Off] : projector will always use the *Projector* color space.
3. When [On] is selected, depending on the color temperature setting a color space request window opens. The color temperature setting must be set to *Projector White*. Click **Yes** to continue.



Image 12-116

4. When [On] is selected and the color temperature is correct, use the ▲ or ▼ key to select the desired color space and press **ENTER** to select.

- Projector     Maximum color space
- EBU            European Broadcasting Union. This organization defines a European standard.
- SMPTE        American standard.
- Custom        The user can define the x and y coordinates for red, green and blue which forms the corners of the color space. By changing the coordinates, the color reproduction can be changed.
- Custom2

**Edit color targets**

Color targets will be used when Custom or Custom2 is selected.

1. Select *Edit Color Targets* and press **ENTER**.

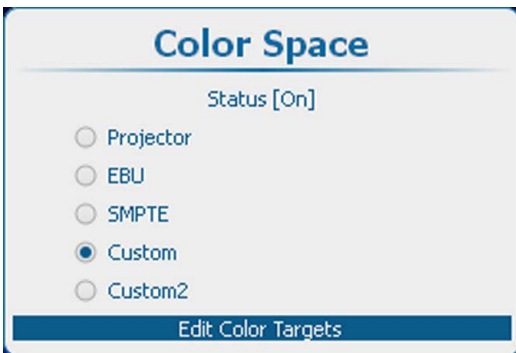


Image 12-117  
Custom, color targets



Image 12-118  
Color targets

2. Use the ▲ or ▼ key to select a color coordinate.  
Use the ◀ or ▶ key to change the value of the selected coordinate.  
Adjust all other coordinates in the same way.



Select **Reset** to return to previous saved values.

## 12.14 ScenergiX

### 12.14.1 Introduction

#### Why ScenergiX ?

When working in a multichannel setup the HDF series projector and its Soft Edge possibilities enable an image blending that gives the appearance of a single view, thus achieving realistic immersion for the majority of wide screen applications.

ScenergiX is limited to half the resolution of the projector.

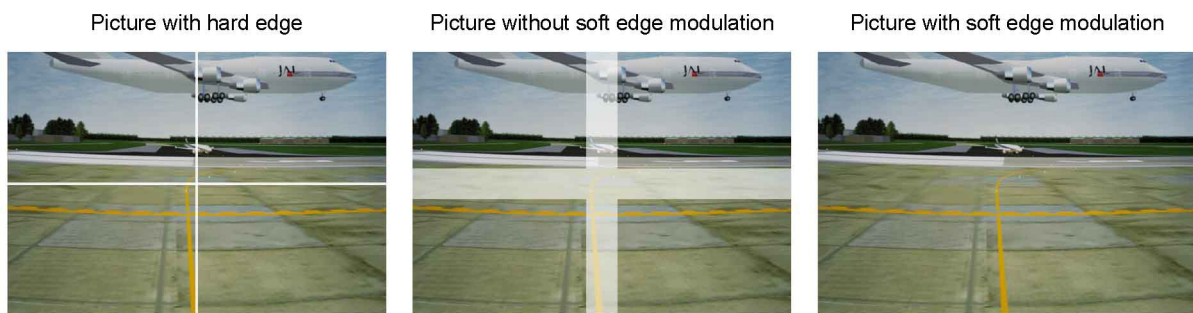


Image 12-119  
Why Soft Edge?

#### What is the Basic Principal of ScenergiX ?

The principle of edge blending is achieved by linear modulation of the light output in the overlap zone so that the light output in that zone equals the light output of the rest of the image.

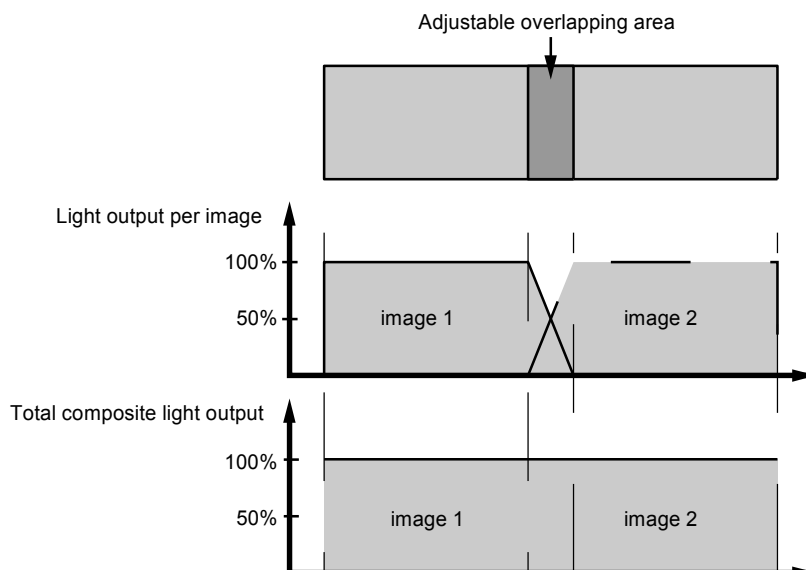


Image 12-120  
ScenergiX Basic Principle

### 12.14.2 Preparations

#### ScenergiX Preparations

To ensure proper ScenergiX adjustment, be sure that the following adjustments are done perfectly on all projectors:

- Convergence
- Geometry
- Color Matching (Color Temperature, Color Standard, Input Balance, Gamma)

### 12.14.3 ScenergiX activation

#### How to activate

1. Press **Menu** to activate the menus and select *Alignment* → *ScenergiX*.

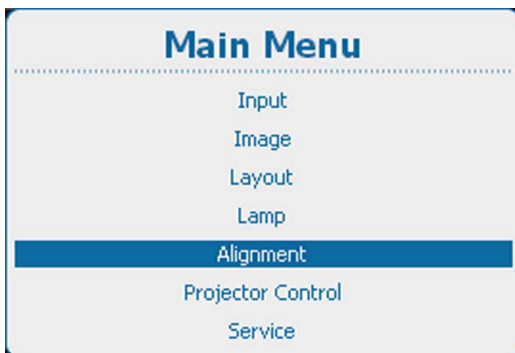


Image 12-121  
Main menu, alignment

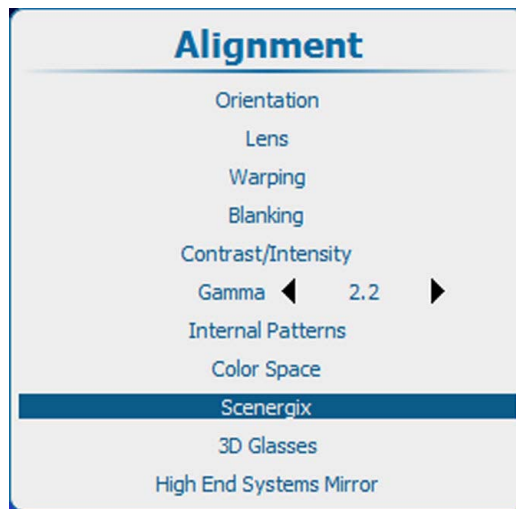


Image 12-122  
Alignment, ScenergiX

2. Press **ENTER** to select.  
The *ScenergiX* menu opens.

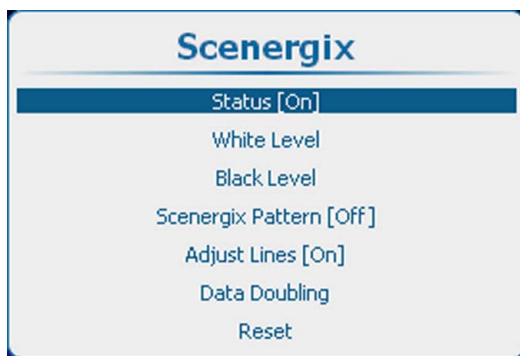


Image 12-123  
ScenergiX, status

3. Use the **▲** or **▼** key to select Status and press **ENTER** to toggle between *[On]* and *[Off]*  
[On] : ScenergiX is activated.  
[Off] : ScenergiX is deactivated

### 12.14.4 ScenergiX pattern

#### What can be done?

To make the ScenergiX adjustment more easy, an internal pattern can be displayed.

#### How to select

1. Press **Menu** to activate the menus and select *Alignment* → *ScenergiX* → *ScenergiX Pattern*.



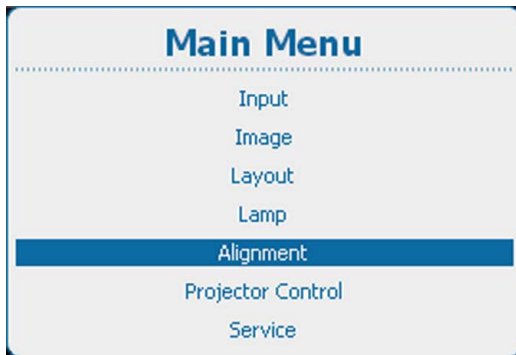


Image 12-124  
Main menu, alignment

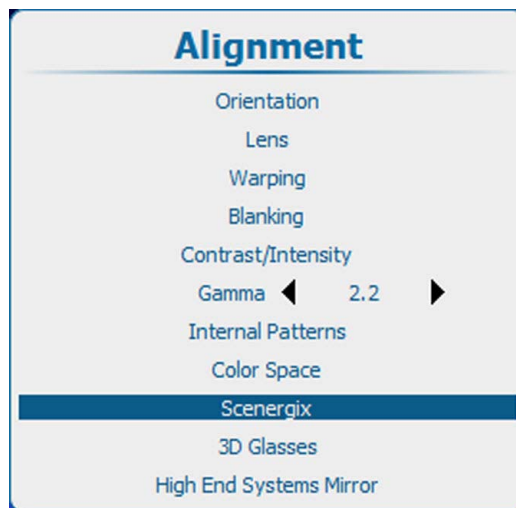


Image 12-125  
Alignment, Scenergix

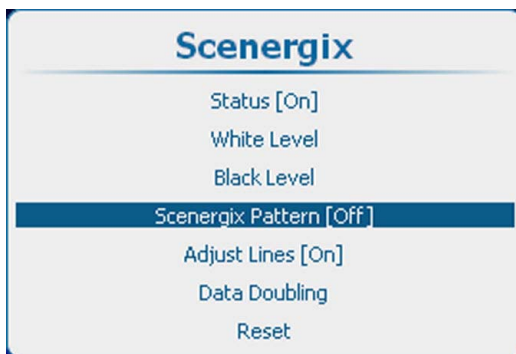


Image 12-126  
Scenergix, pattern activation

2. Press **ENTER** to toggle between [On] or [Off].

[On] : Internal scenergix pattern is displayed.

[Off] : no scenergix pattern is displayed.

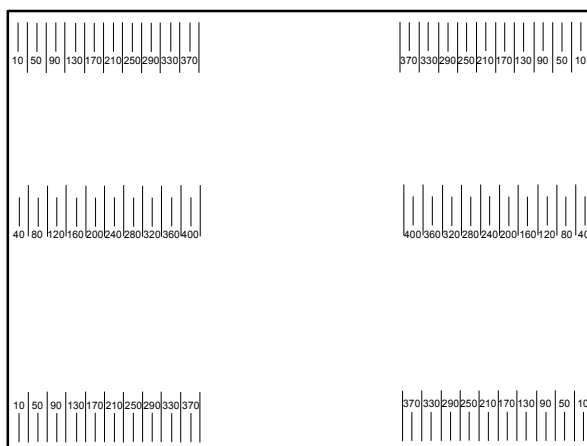


Image 12-127  
Scenergix pattern

### 12.14.5 Scenergix adjustment lines

#### What can be done?

Border lines for the blending areas can be displayed while adjusting the white and black level.



Adjustment lines can be activated when *Scenergix pattern* is [On].

### How to display

1. Press **Menu** to activate the menus and select *Alignment* → *Scenergix* → *Adjust lines*.

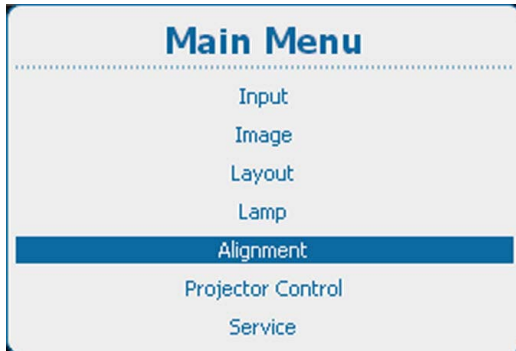


Image 12-128  
Main menu, alignment

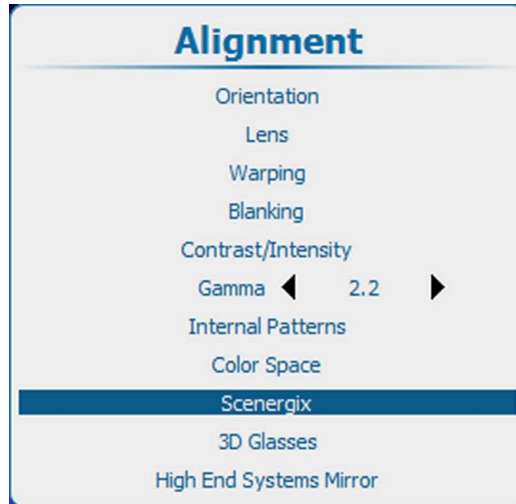


Image 12-129  
Alignment, Scenergix

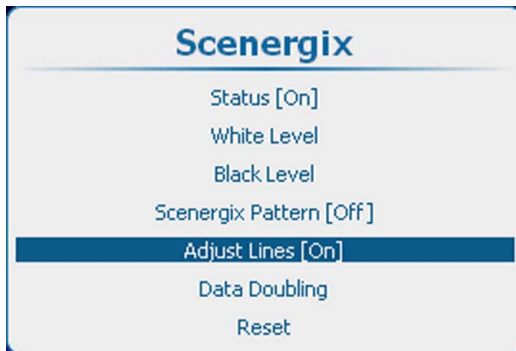


Image 12-130

2. Press **ENTER** to toggle between [On] and [Off].

### 12.14.6 Data doubling

#### About data doubling

When a source (A) must be displayed via 2 projectors as one image (B), the vertical and horizontal start position and the size must be determined so that each projector displays a part of the image. The overlap area can be adjusted with the Scenergix tools.

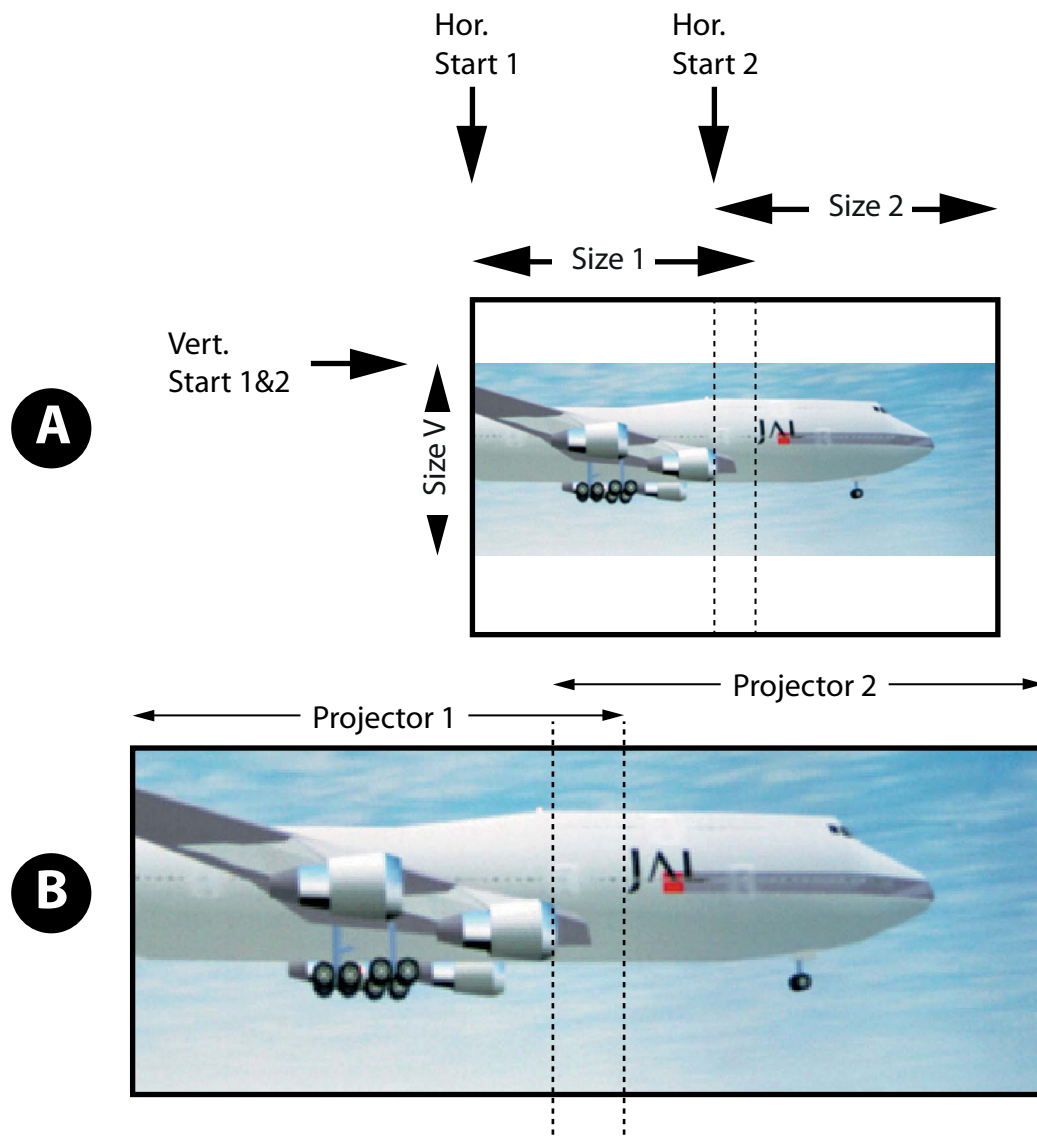


Image 12-131  
Data doubling

A Source  
B Projected image

Activate data doubling on both projectors and setup the vertical and horizontal start for projector 1 and projector 2.

### How to setup

1. Press **Menu** to activate the menus and select *Alignment* → *Scenergix* → *Data doubling*.

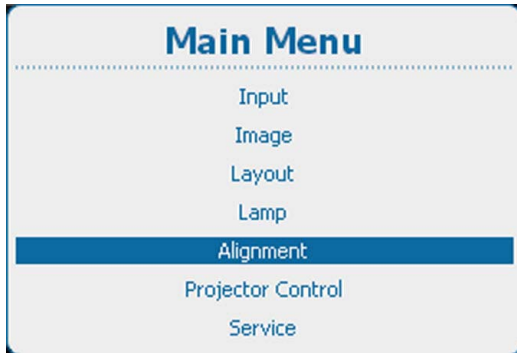


Image 12-132  
Main menu, alignment

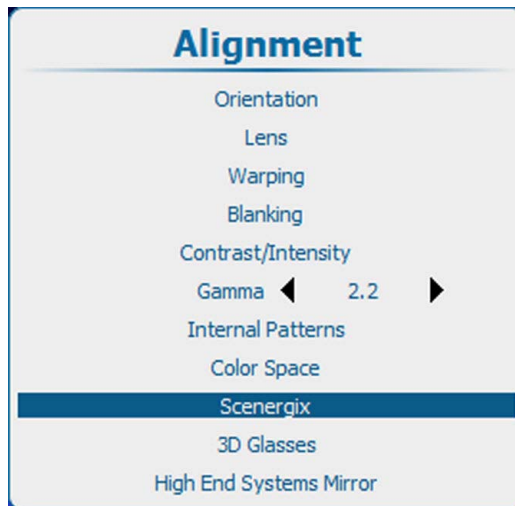


Image 12-133  
Alignment, Scenergix

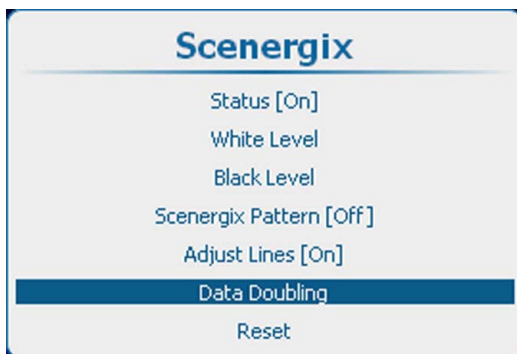


Image 12-134  
Scenergix, data doubling

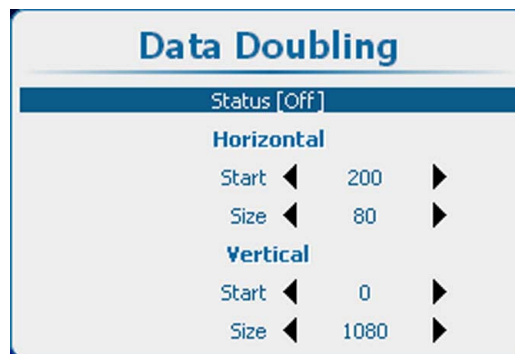


Image 12-135  
Data doubling, status

2. Select Status and press **ENTER** to toggle between [On] and [Off].  
 [On] : data doubling is activated.  
 [Off] : data doubling is deactivated.
3. Select Horizontal Start and use the ◀ or ▶ key to set the correct start position.
4. Do the same for Horizontal Size, Vertical Start and Vertical Size.
5. Repeat this action for the second projector.

### 12.14.7 White level adjustment (blending area)

#### How to set

1. Press **Menu** to activate the menus and select *Alignment* → *Scenergix* → *White level*.

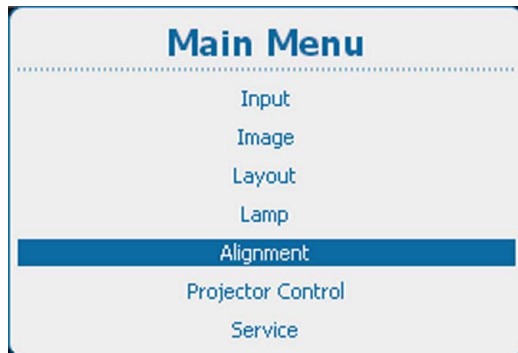


Image 12-136  
Main menu, alignment

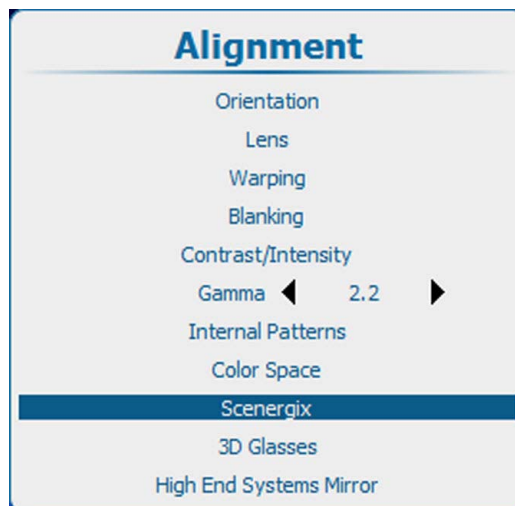


Image 12-137  
Alignment, Scenergix

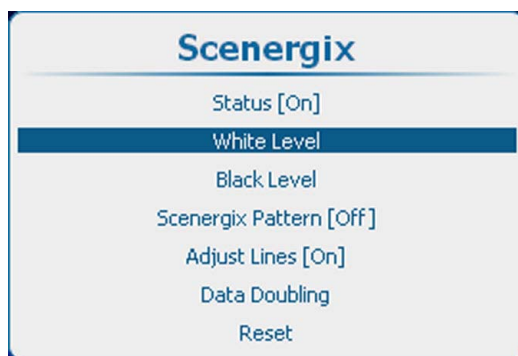


Image 12-138  
Scenergix, white level

2. Press **ENTER** to select the *White level* adjustments.

The White level position menu opens.

When Adjustment lines is [On], the different areas are displayed on the screen.



Image 12-139  
White level position

3. Use the **▲** or **▼** key to select one of the four size adjustments and press **ENTER** to select  
Use the **◀** or **▶** key to change the border of the blending area to the desired position (value between 0 and 255)

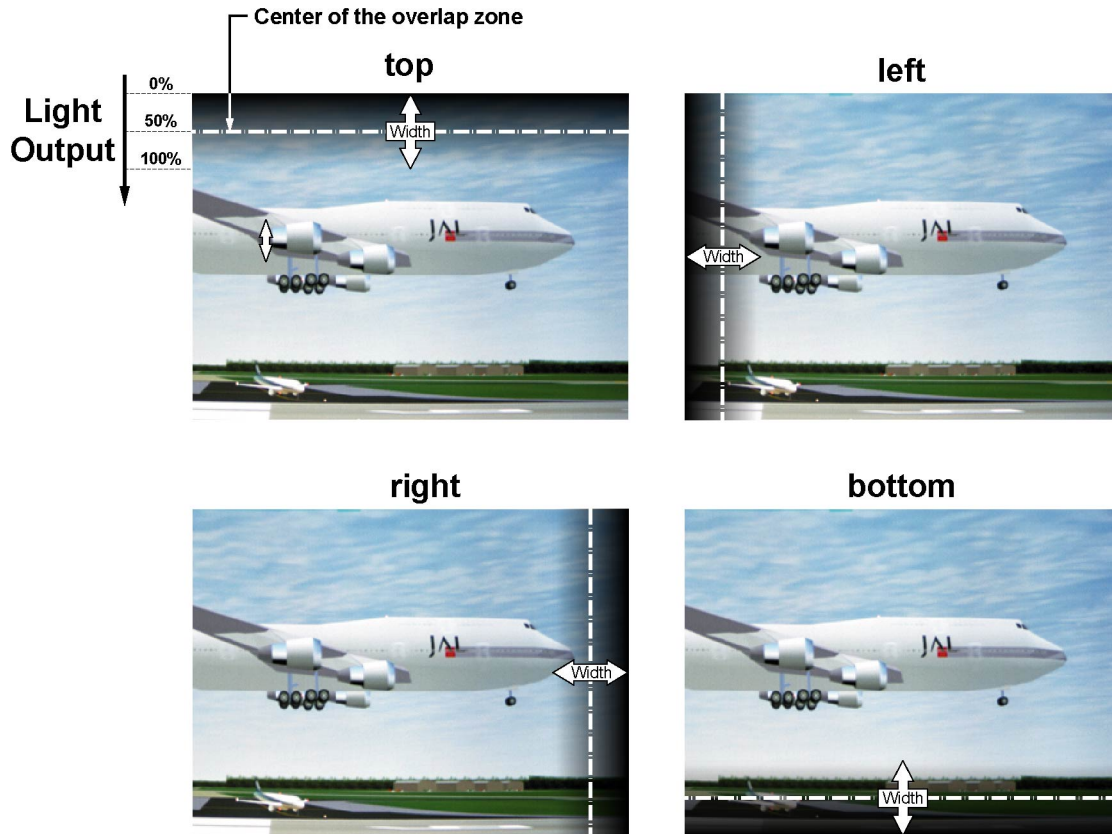


Image 12-140  
Width selections

4. Set first the width for the first projector and repeat for the second one.

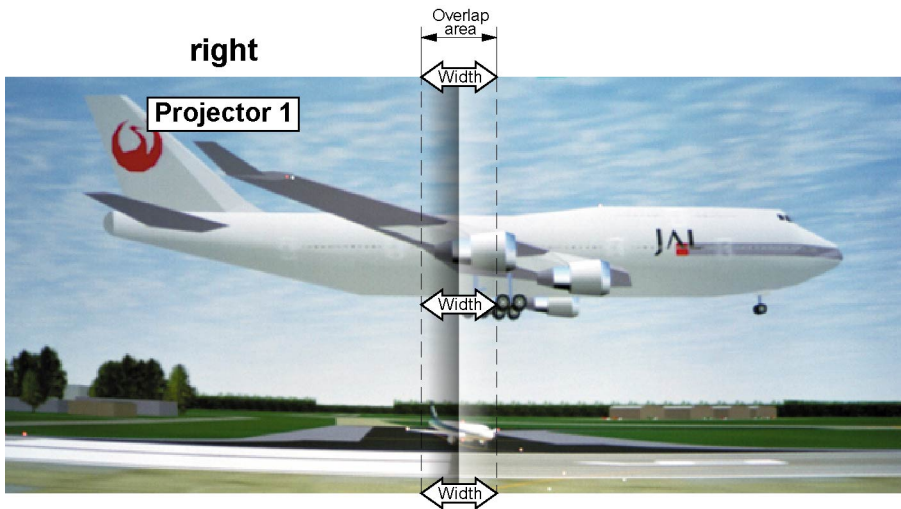


Image 12-141  
Width set up for projector 1

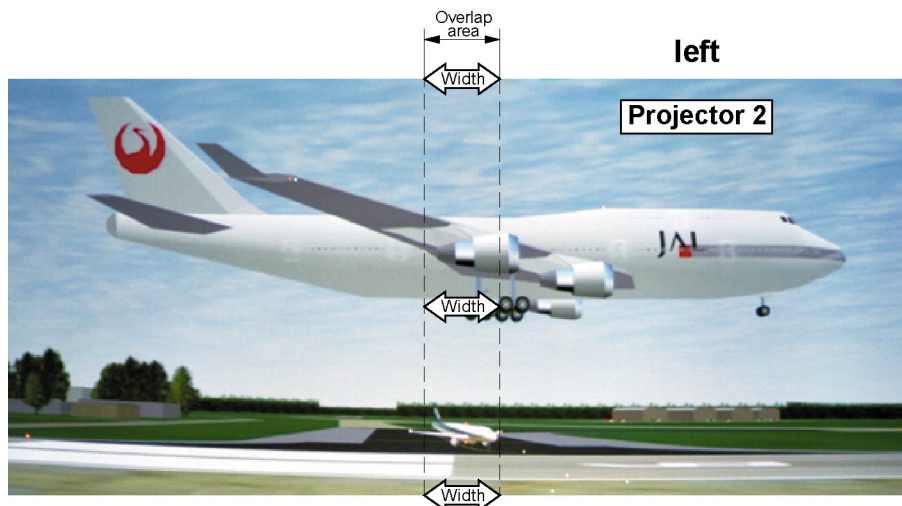


Image 12-142  
Width set up for projector 2



To eliminate all blending settings, select **Reset** and press **ENTER**.

### 12.14.8 Black level adjustment

#### Why black level adjustment

For dark images, the overlap zone will be brighter than the rest of the images. Typically for DLP projectors, next to the overlap zone, a brighter area is recognized. This area is known as a DLP leakage area. This area must also be excluded for the black level adjustment. Therefore we can rise the black level of the remaining image (excluding the overlap zone and the DLP leakage area).

First, the width of the leakage area must be set. The white cursor line indicates the border of the overlap area. The green cursor line indicates the current installed DLP leakage area border and starts at the position of the white cursor line (no width installed). This green line can be moved to the border of the DLP leakage area with the cursor keys.

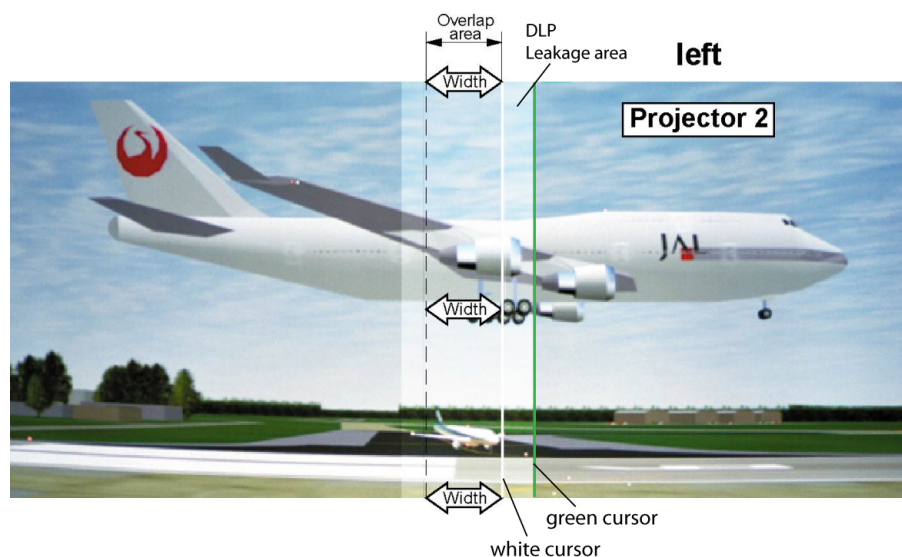


Image 12-143  
DLP Leakage area set up



After the area is set, use **TEXT** key to remove the area border lines when adjusting the black level.

#### How to set the leakage area width

1. Press **Menu** to activate the menus and select *Alignment* → *Scenexig* → *Black level*.

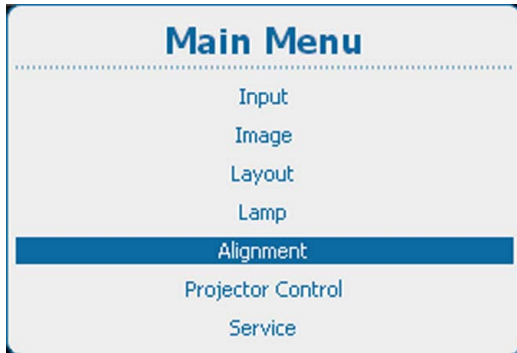


Image 12-144  
Main menu, alignment

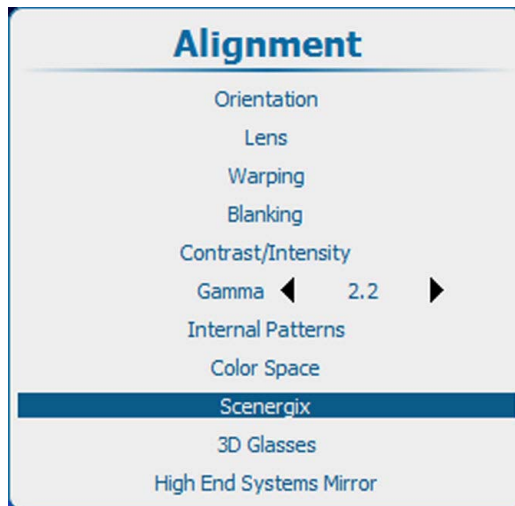


Image 12-145  
Alignment, Scenergix

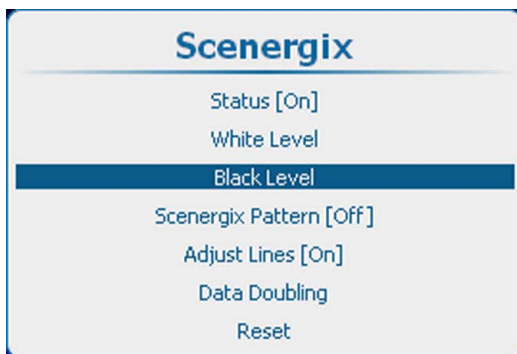


Image 12-146  
Scenergix, Black level

2. Press **ENTER** to select the *Black Level* adjustments.

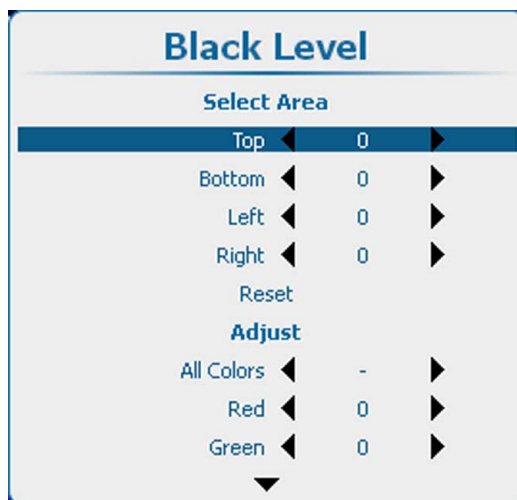


Image 12-147  
Black level, area

3. Use the **▲** or **▼** key to select one of the four size adjustments.  
Use the **◀** or **▶** key to move the green border line to the desired position.



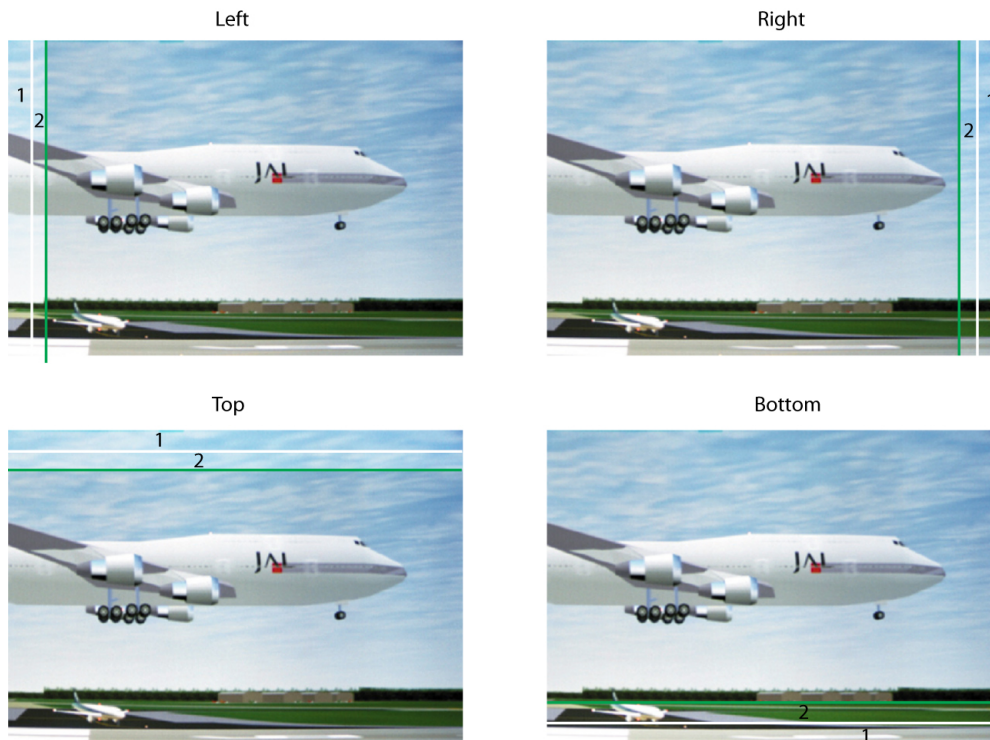


Image 12-148  
DLP leakage area

- 1 Overlap area
- 2 DLP Leakage area



Use the **Reset** item to reset all area values.

### How to adjust

1. Press **Menu** to activate the menus and select *Alignment* → *Scenergix* → *Black level*.

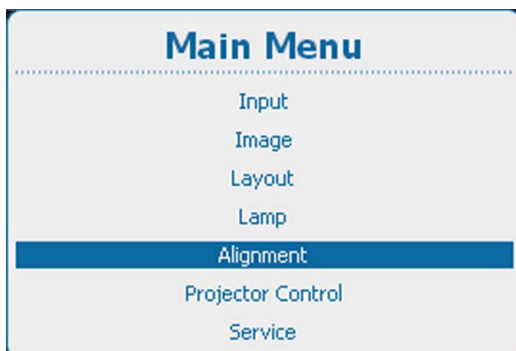


Image 12-149  
Main menu, alignment

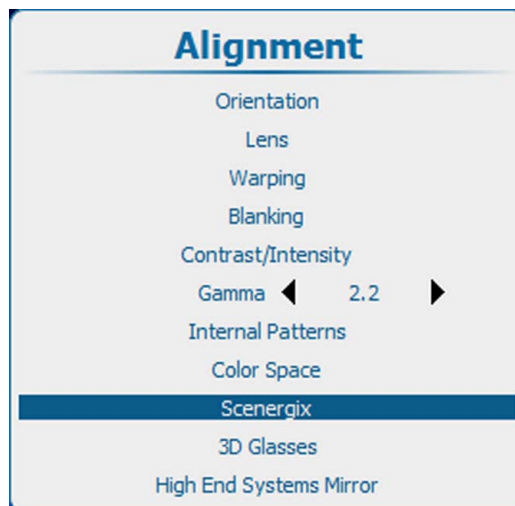


Image 12-150  
Alignment, Scenergix

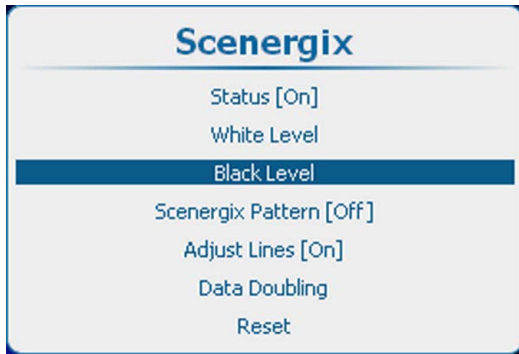


Image 12-151  
Scenergix, Black level

2. Press **ENTER** to select and use the **▲** or **▼** key to select a color to adjust or select *All colors* to adjust all colors at the same time.

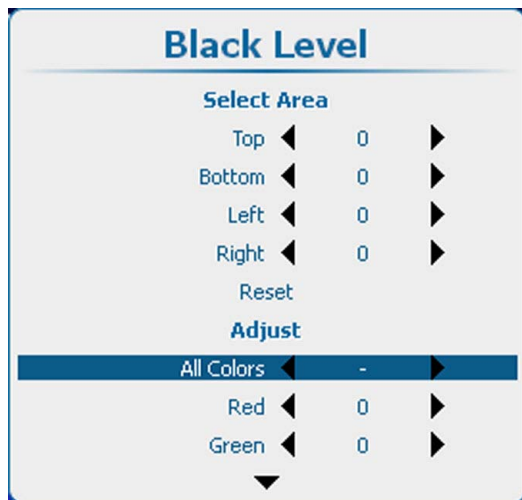


Image 12-152  
Black level, adjust

3. Adjust the black level of area A until the black level of area A, B and C are equal. Use the Adjust function Red, Green and Blue in the Black level menu.

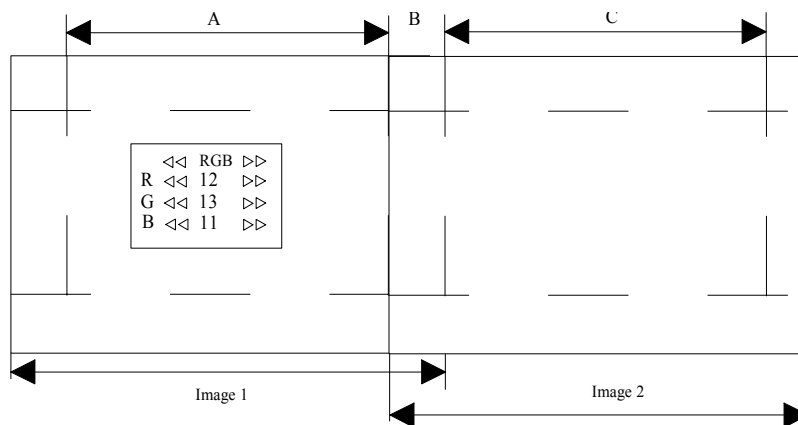


Image 12-153  
Black level adjustment



Use the *Reset* item to set all values back to zero.

### 12.14.9 Scenergix Reset

#### What can be done?

All Scenergix values can be set back to the default values.

## How to reset

1. Press **Menu** to activate the menus and select *Alignment* → *Scenergix* → *Reset*.

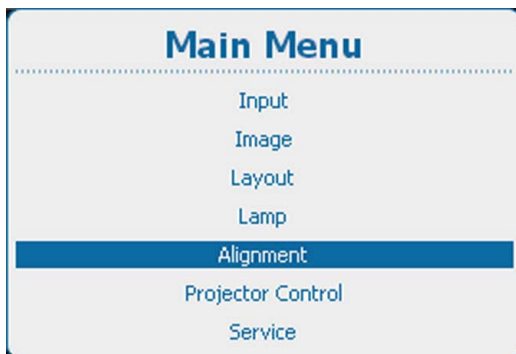


Image 12-154  
Main menu, alignment

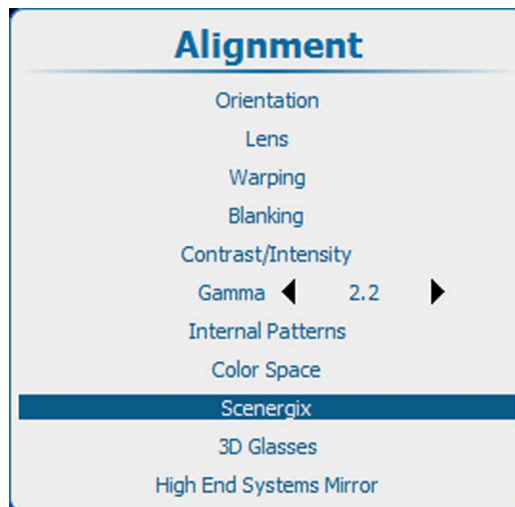


Image 12-155  
Alignment, Scenergix

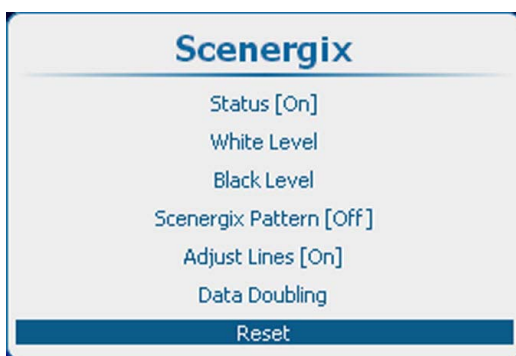


Image 12-156  
Scenergix, reset

2. Press **ENTER** to reset the Scenergix value.  
All value are set back to the default values.

## 12.15 3D Glasses

### Overview

- Dark time adjustment
- Left-right output reference delay
- 3D Sync Loop Through

### 12.15.1 Dark time adjustment

#### What can be done?

The principle of a pair of Stereo Glasses is :

1. When the left image is projected, the left shutter is open, allowing the left eye to see the left image. The shutter for the right eye is closed.
2. During the blanking period, before projecting the right image, the left shutter is closed and the right shutter will open.
3. The right image is projected, the right shutter is open, allowing the right eye to see the right image.

The ideal situation is when the opening/closing times of these shutters are in sync with the blanking time of DLP mirrors.

**Opening + Closing = Blanking Time**

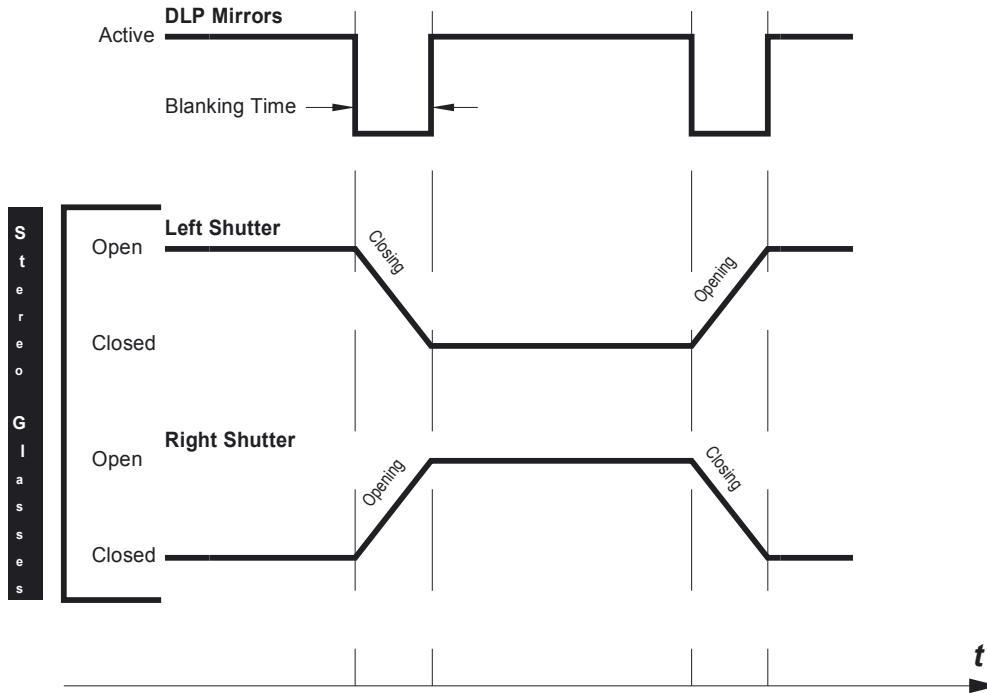


Image 12-157  
Opening/closing times of the shutters in sync with the blanking time

Closing these shutters too late and/or opening too early will cause Cross-Talk.

**Opening Too Early and/or Closing Too Late = Cross Talk**

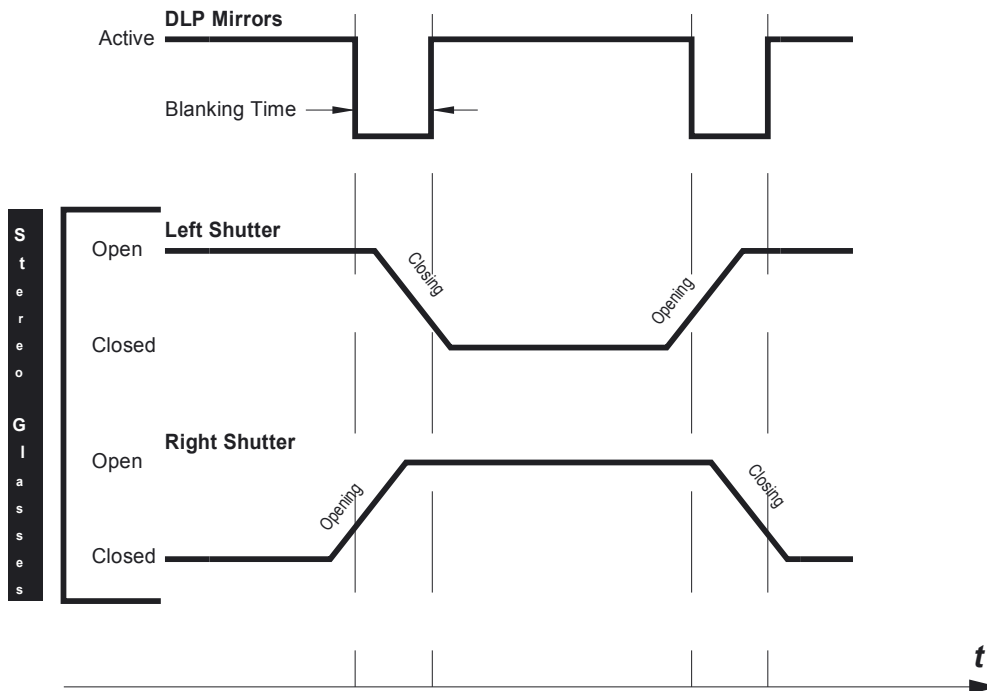


Image 12-158  
Shutters closing too late and/or opening too early cause Cross-Talk

Closing these shutters too quickly and/or opening too slowly will cause Color Artifacts.

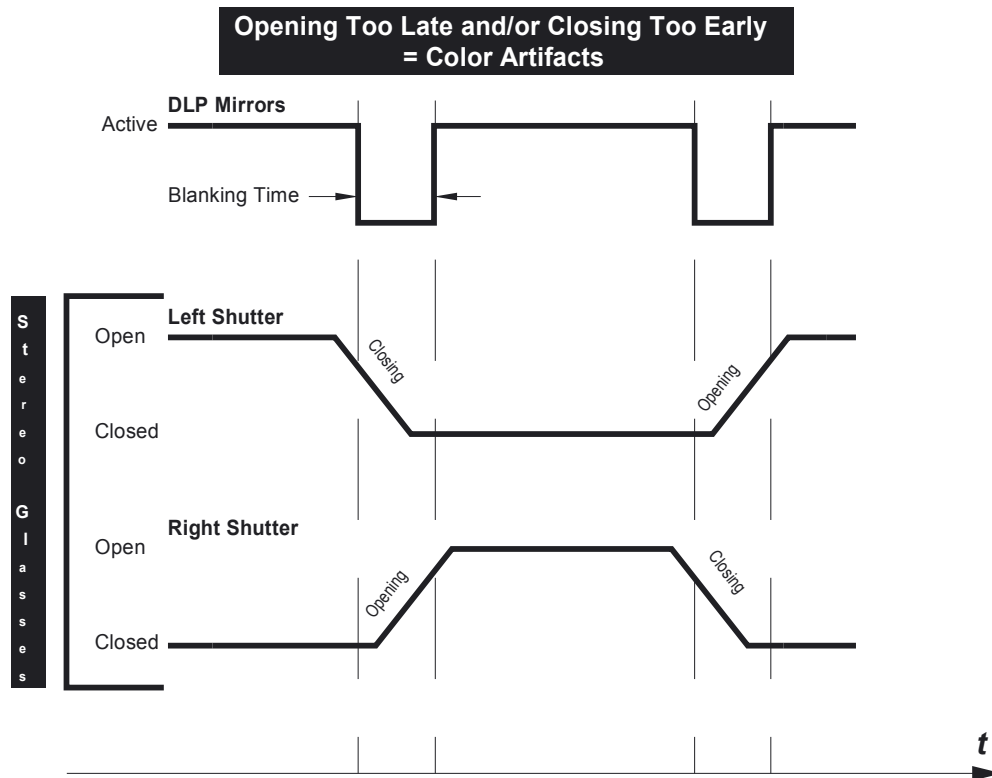


Image 12-159  
Shutters closing too early and/or opening too late cause Color Artifacts

Adjusting the Dark Time will allow an easy synchronization of the Blanking Period of the DLP mirrors with the opening/closing time of the shutters in the Stereo Glasses.

### How to adjust the dark time

1. Press **Menu** to activate the menus and select *Alignment* → *3D Glasses* .

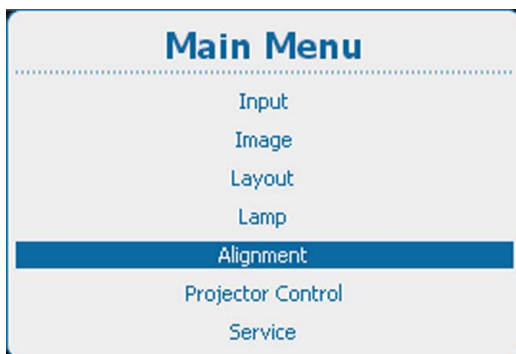


Image 12-160  
Main window

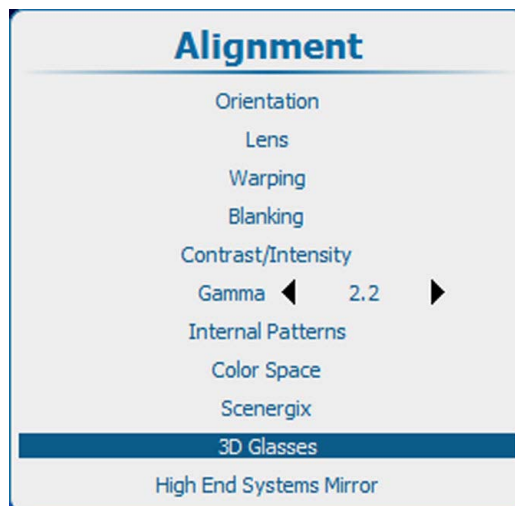


Image 12-161  
Alignment, 3D glasses

2. Press **ENTER**.
3. Use the **▲** or **▼** key to select *Dark Time Adjustment*

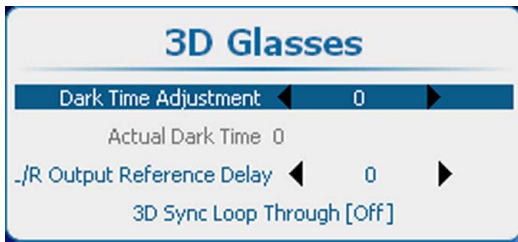


Image 12-162  
Dark time adjustment

- Use the ◀ or ▶ key to change the dark time until the correct value is reached.  
The actual used dark time is indicated next to *Actual Dark Time*.

### 12.15.2 Left-right output reference delay

#### What can be done?

With L/R output reference delay it is possible to apply an adjustable time delay on the stereo emitter signal.

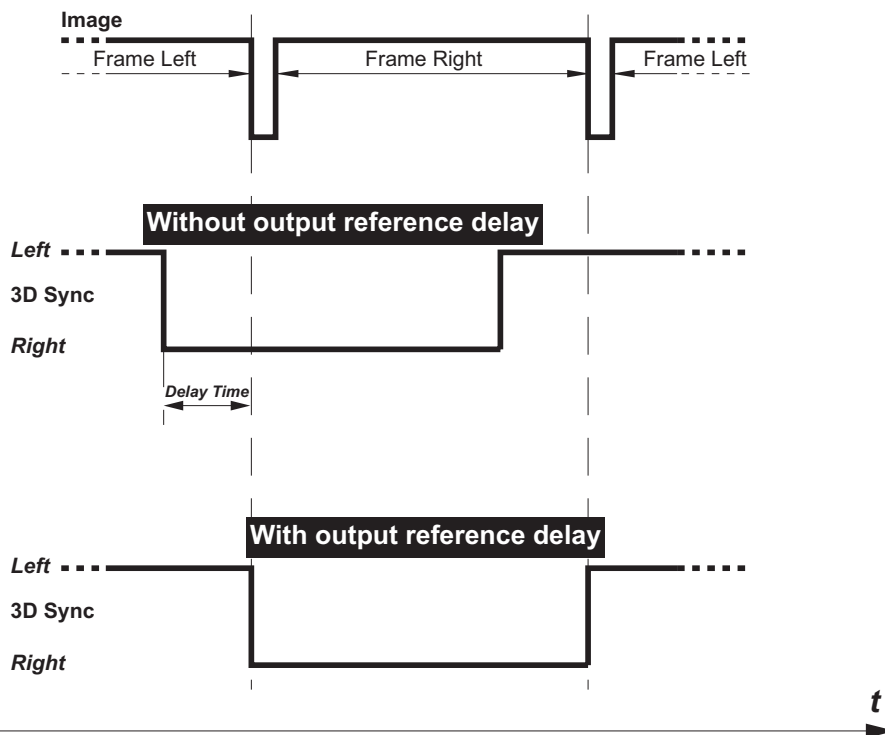


Image 12-163  
3D Output reference delay

#### How to set the delay

- Press **Menu** to activate the menus and select *Alignment* → *3D Glasses* .

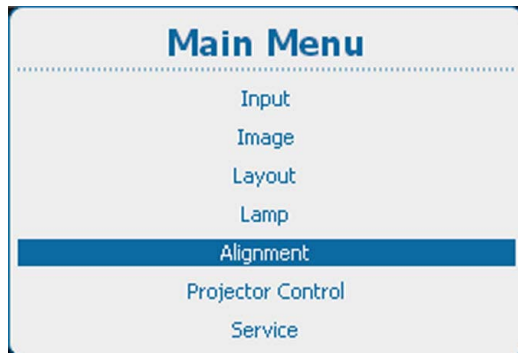


Image 12-164  
Main window

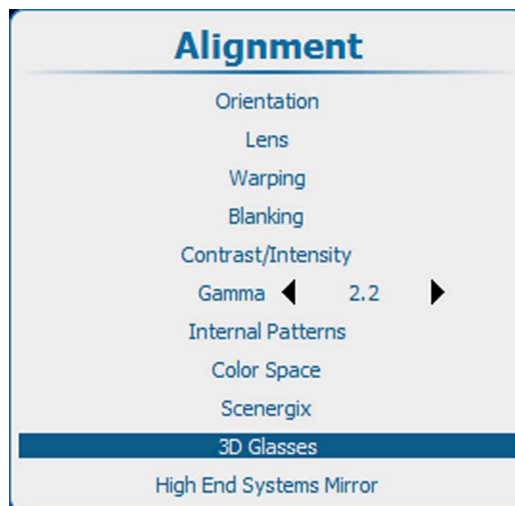


Image 12-165  
Alignment, 3D glasses

2. Press **ENTER**.
3. Use the ▲ or ▼ key to select *L/R Output Reference Delay*

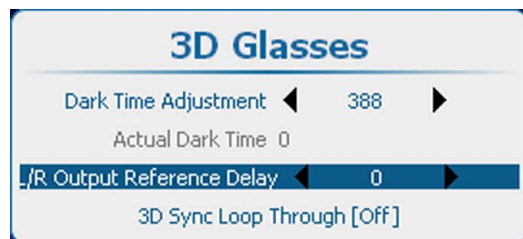


Image 12-166  
Output reference delay

4. Use the ◀ or ▶ key to change the L/R Output Reference Delay value until the correct value is reached.

### 12.15.3 3D Sync Loop Through

#### What can be done?

The incoming 3D sync signal can be routed to the 3D sync output connector.

#### How to activate

1. Press **Menu** to activate the menus and select *Alignment* → *3D Glasses*.

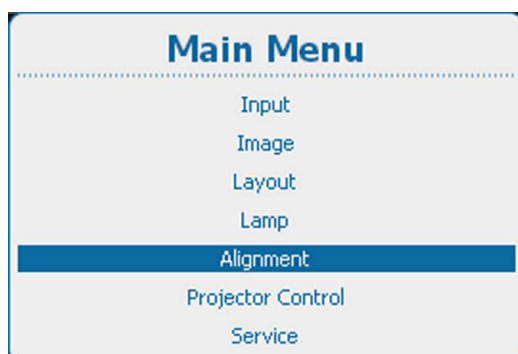


Image 12-167  
Main window

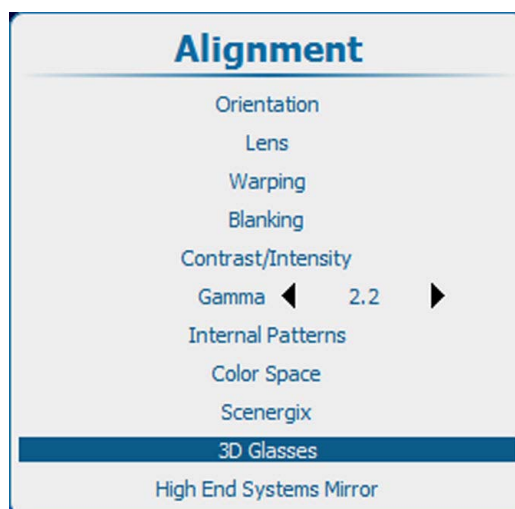


Image 12-168  
Alignment, 3D glasses

## 12. Alignment

2. Press **ENTER**.
3. Use the ▲ or ▼ key to select *3D Sync Loop Through*.

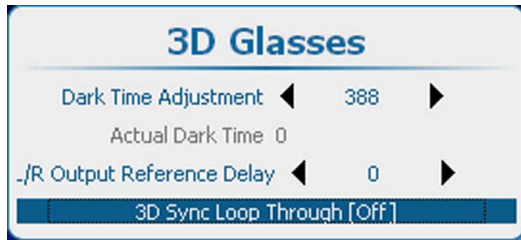


Image 12-169  
3D sync loop through

4. Press **ENTER** to toggle between *[On]* and *[Off]*.

[On] : 3D SYNC OUT is directly routed from 3D SYNC IN

[Off] : the internal 3D sync signal is available on 3D SYNC OUT, native or inverted as indicated in the 'Invert 3D Sync Out' setting.

## 12.16 High End Systems Mirror

### About the mirror

The digital mirror is DMX controlled. This control can be done via the projector or via Projector Toolset. External DMX control is still possible. Almost any image can be displayed on almost any place in the room using the pan and tilt adjustments. Settings storing per layout is possible.

### Projector control activation

1. Press **Menu** to activate the menus and select *Alignment* → *High End Systems Mirror*.

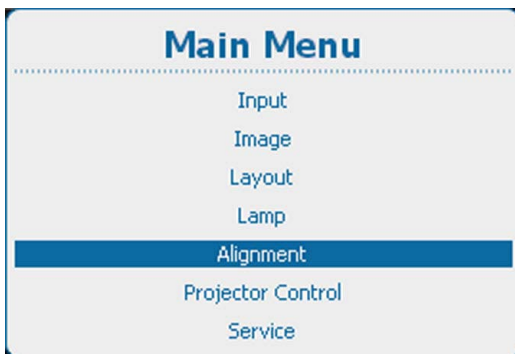


Image 12-170  
Main menu, alignment

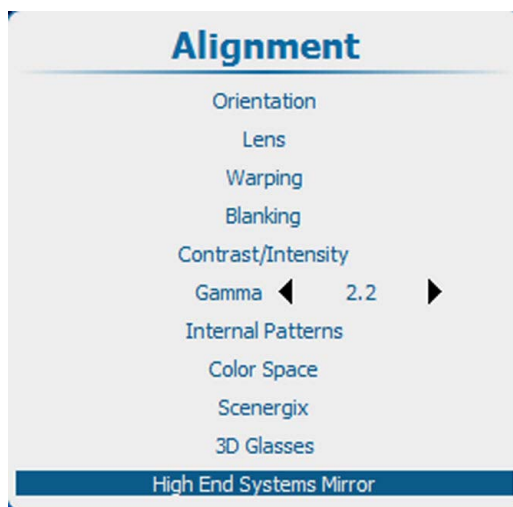


Image 12-171  
Alignment, High End Systems Mirror





Image 12-172

- Use the ▲ or ▼ key to select *Projector Controlled* and press **ENTER** to toggle between *[On]* and *[Off]*.  
*[On]* : High End Systems Mirror is controlled via the projector.  
*[Off]* : High End Systems Mirror is not controlled via the projector.

### Pan - Tilt adjustment

- Use the ▲ or ▼ key to select Coarse Pan or Coarse Tilt.



Image 12-173

- Use the ◀ or ▶ key to change the value between -128 and 128.
- Use the ▲ or ▼ key to select Fine Pan or Fine Tilt.
- Use the ◀ or ▶ key to change the value between -128 and 128.

### Store settings

- To change the store settings, use the ▲ or ▼ key to select Store settings per layout and press **ENTER** to toggle between *[No]* and *[Yes]*.

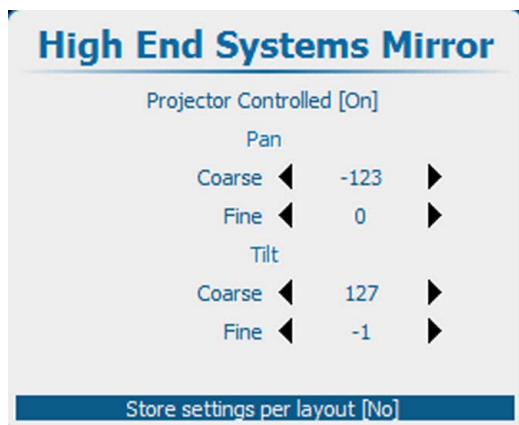


Image 12-174

## 12. Alignment

---

[No] : settings are stored globally.

[Yes] : settings are stored per layout.

# 13. PROJECTOR CONTROL

## Overview

- Projector Control menu overview
- Individual Projector Address
- Projector Common Address
- Serial Communication
- Network
- IR Control switching
- DMX
- Buttons
- Menu position
- Local LCD
- Language selection
- Scheduler
- GSM Configuration, activation
- GSM Configuration, subscription
- FLEX, light output configuration
- SMS services

## 13.1 Projector Control menu overview

### Overview table

Level 1	Level 2	Level 3
Projector Control	Projector Address	Projector address Common address
	Serial Communication	Baud rate Interface standard
	Network	Wired DHCP [On] [Off] IP address Subnet mask Default gateway Wireless Status DHCP IP address Subnet mask
	IR Control	IR front IR back IR side
	DMX	Address Universe Mode Art DMX [On/Off] Output voltage enable Output voltage level Monitor Shutdown

	Shutdown time
Buttons	Shortcut keys
	Standby button
Menu position	Menu position
	Bar scale position
Local LCD	Back light
	Time out
Change Language	
Scheduler	Add task
	Edit task
	Delete task
	Scheduler on/off
GSM configuration	PIN code
	SMS subscription

## 13.2 Individual Projector Address

### About individual projector address

Before a projector, and only this projector, can be controlled via a remote control, an individual address must be entered in the projector.

This individual projector address can then be used to control the projector via remote control or via a serial connection.

Next to an individual projector address, each projector has also a common address for group control.

### How to set the address

1. Press **Menu** to activate the menus and select *Projector Control* → *Projector Address* → *Projector Address*.

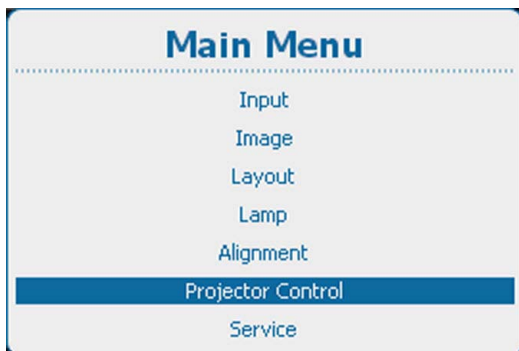


Image 13-1  
Main menu, projector control

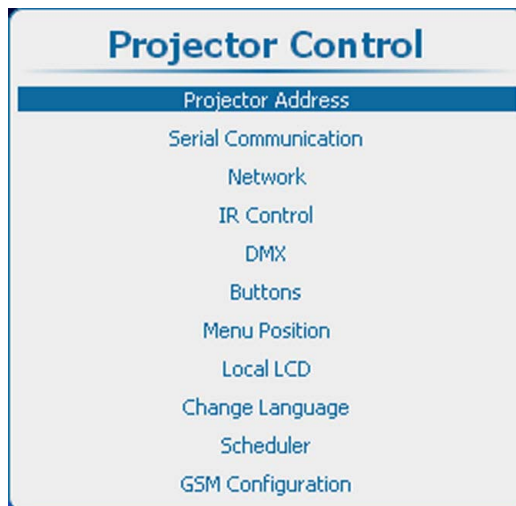


Image 13-2  
Projector control, projector address



Image 13-3  
Projector address

2. Press **ENTER** to activate the address input.



Image 13-4  
Projector address, input

- Use the ▲ or ▼ key to change the selected character.  
Use the ◀ or ▶ key to select another character.

**Note:** Digits can be entered with the digit keys on the remote control or the local keypad. When a digit is entered in that way, the next character will be selected automatically.

### 13.3 Projector Common Address

#### About common address

A common address can be '0' or '1'.

Any command coming from a remote control programmed with that common address will be executed.

#### How to set

- Press **Menu** to activate the menus and select *Projector Control* → *Projector Address* → *Common Address*.

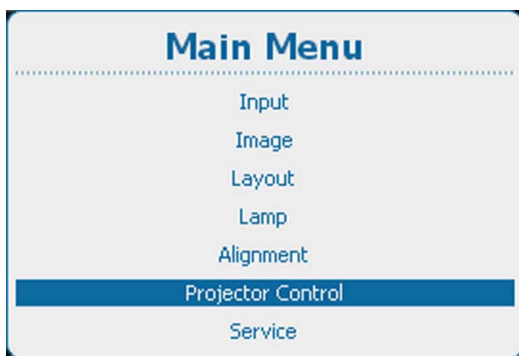


Image 13-5  
Main menu, projector control

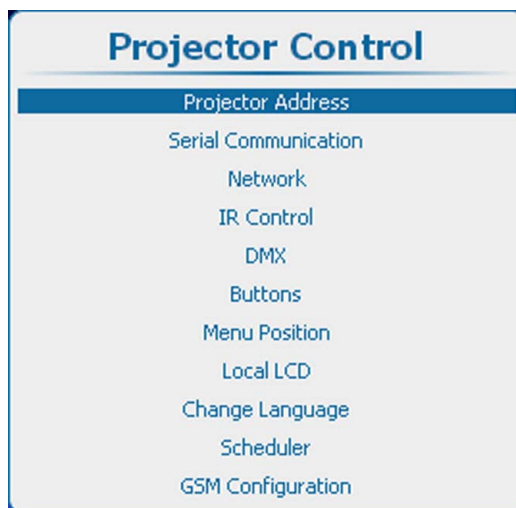


Image 13-6  
Projector control, projector address

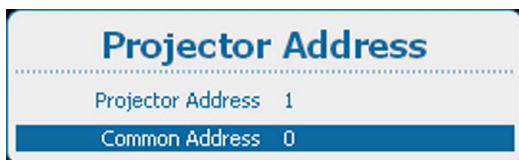


Image 13-7  
Projector address, common address

- Press **ENTER** to activate the address input.



Image 13-8  
Projector common address

## 13.4 Serial Communication

### Overview

- Baud rate setup
- Interface Standard

#### 13.4.1 Baud rate setup

##### What can be done ?

The baud rate for to establish a serial communication with a computer can be set.

##### How to set

1. Press **Menu** to activate the menus and select *Projector Control* → *Serial Communication* → *Baudrate*.

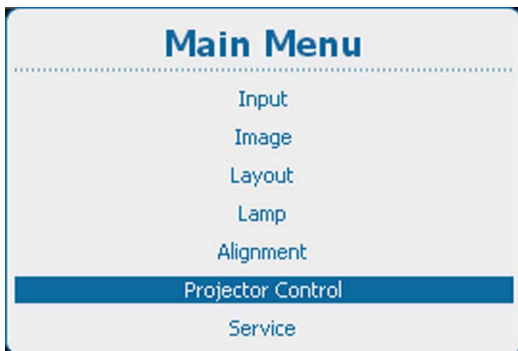


Image 13-9  
Main menu, projector control

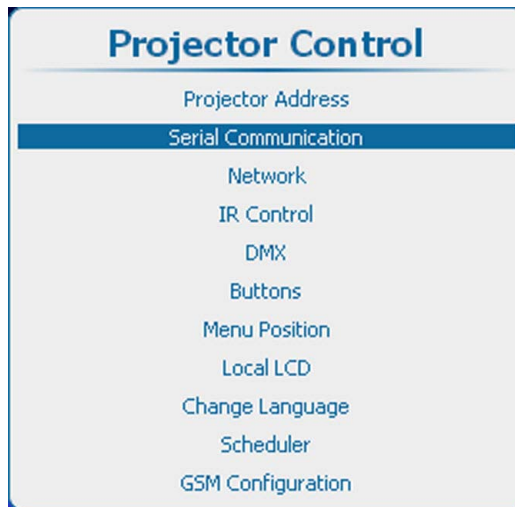


Image 13-10  
Projector control, serial communication



Image 13-11  
Serial communication, baud rate

2. Press **ENTER** to toggle between the available baud rates.  
The following baud rates can be selected:
  - 9600
  - 19200
  - 38400
  - 57600
  - 115200

#### 13.4.2 Interface Standard

##### What can be done?

The communication protocol for the communication between the projector and a computer can be set to RS232 or RS422.

##### How to set up

1. Press **Menu** to activate the menus and select *Projector Control* → *Serial Communication*.

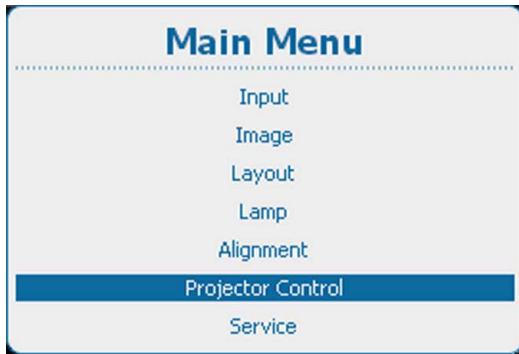


Image 13-12  
Main menu, projector control

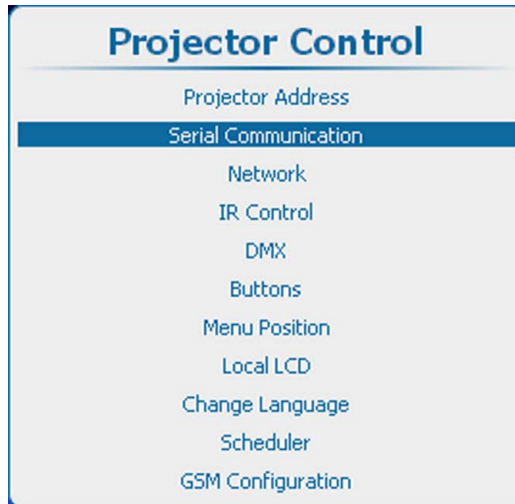


Image 13-13  
Projector control, serial communication

- Use the ▲ or ▼ key to select *Interface Standard*. Press **ENTER** to toggle between *[RS232]* or *[RS422]*.



Image 13-14  
Interface standard

## 13.5 Network

### About a network connection

A network connection can be made via a wired connection or via the optional wireless unit.

#### Overview

- Introduction to a Network connection
- Wired DHCP set up
- Wired IP address set up
- Wired subnet mask set up
- Wired default gateway set up
- Wireless network activation
- Wireless access points selection and setup
- Wireless DHCP set up
- Wireless fixed IP address set up
- Wireless subnet mask set up
- Wireless default gateway set up

### 13.5.1 Introduction to a Network connection



#### DHCP

Dynamic host configuration protocol. DHCP is a communications protocol that lets network administrators manage centrally and automate the assignment of IP addresses in an organization's network. Using the Internet Protocol, each machine that can connect to the Internet needs a unique IP address. When an organization sets up its computer users with a connection to the Internet, an IP address must be assigned to each machine. Without DHCP, the IP address must be entered manually at each computer and, if computers move to another location in another part of the network, a new IP address must be entered. DHCP lets a network administrator supervise and distribute IP addresses from a central point and automatically sends a new IP address when a computer is plugged into a different place in the network.



**IP**

Internet Protocol. The network layer of TCP/IP. Required for communication with the internet.



**Subnet mask**

A number that is used to identify a subnetwork so that IP addresses can be shared on a local area network.



**Default Gateway**

A router that serves as an entry point into and exit point out of a network. For example, a local network (LAN) may need a gateway to connect it to a wide area network (WAN) or to the Internet.



**MAC address**

Media Access Control address. Unique hardware number, used in combination with the IP-address to connect to the network (LAN or WAN).

**What should be set up for an Ethernet address?**

2 ways can be used to assign an address:

- use the DHCP setting so that an automatic address will be assigned.
- Assign manually an IP address, Net-mask (subnet-mask), (default) gateway address.
  - Set the IP-Address field to the desired value. This must NOT be 0.0.0.0 for static IP-Address assignment. The IP address identifies a projector's location on the network in the same way a street address identifies a house on a city block. Just as a street address must identify a unique residence, an IP address must be globally unique and have a uniform format.
  - Set the Subnet-Mask as appropriate for the local subnet.
  - Set the Default-Gateway to the IP-Address of the local router (MUST be on the local subnet!) on the same network as this projector that is used to forward traffic to destinations beyond the local network. This must not be 0.0.0.0. If there is no router on the projector's local subnet then just set this field to any IP-Address on the subnet.

**13.5.2 Wired DHCP set up**

**How to set up**

1. Press **Menu** to activate the menus and select *Projector Control* → *Network*.

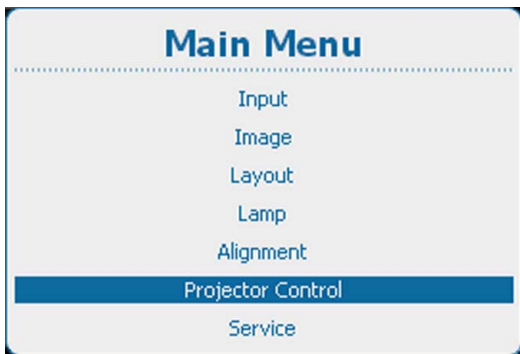


Image 13-15  
Main menu, projector control

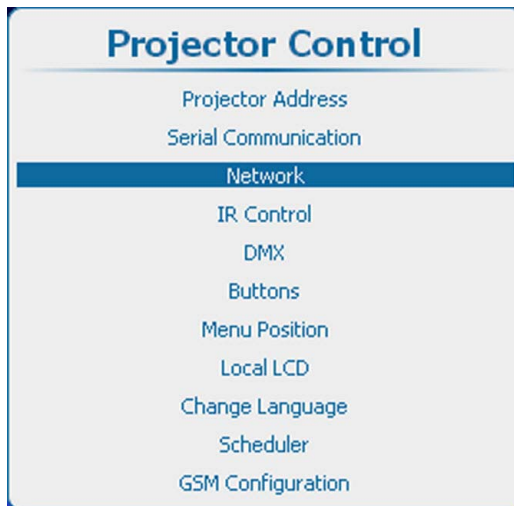


Image 13-16  
Projector control, network





Image 13-17  
Wired DHCP

- Use the ▲ or ▼ key to select *DHCP* under *Wired* and press **ENTER** to toggle between *[On]* or *[Off]*.

[On] : DHCP is activated. An automatic IP address is assigned.

[Off] : DHCP is deactivated. A fixed address must be used.

### 13.5.3 Wired IP address set up

#### How to set up

- Press **Menu** to activate the menus and select *Projector Control* → *Network*.

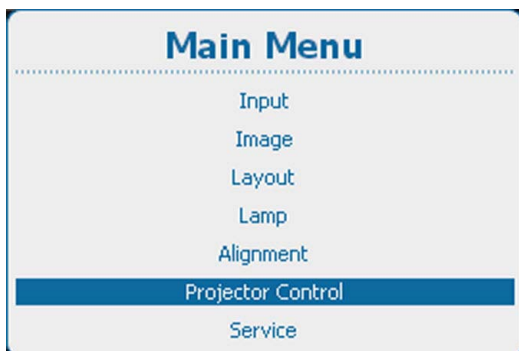


Image 13-18  
Main menu, projector control

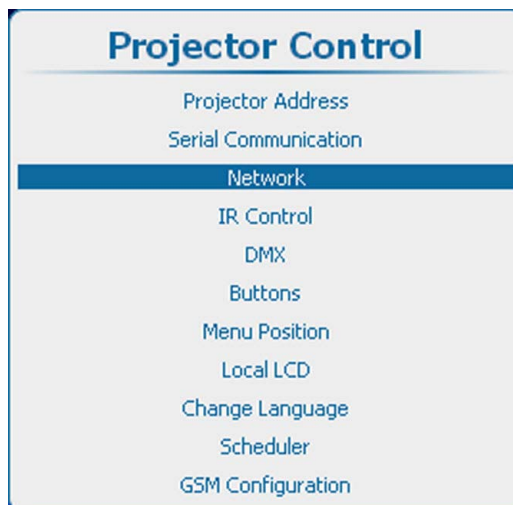


Image 13-19  
Projector control, network



Image 13-20

2. Use the ▲ or ▼ key to select *IP Address* under *Wired* and press **ENTER** to activate the input box.



Image 13-21

3. Use the ▲ or ▼ key to change the selected character.  
Use the ◀ or ▶ key to select another character.  
**Note:** *Digits can be entered with the digit keys on the remote control or the local keypad. When a digit is entered in that way, the next character will be selected automatically.*

### 13.5.4 Wired subnet mask set up



**Subnet for Wired and Wifi must be different !**

---

#### How to set up

1. Press **Menu** to activate the menus and select *Projector Control* → *Network*.

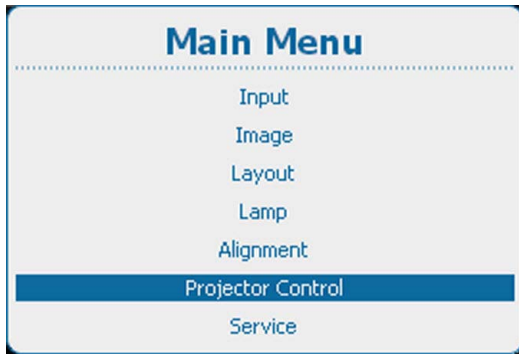


Image 13-22  
Main menu, projector control



Image 13-23  
Projector control, network



Image 13-24  
Subnet mask

- Use the ▲ or ▼ key to select *Subnet Mask* under *Wired* and press **ENTER** to activate the input box.



Image 13-25

- Use the ▲ or ▼ key to change the selected character. Use the ◀ or ▶ key to select another character.

**Note:** Digits can be entered with the digit keys on the remote control or the local keypad. When a digit is entered in that way, the next character will be selected automatically.

### 13.5.5 Wired default gateway set up

#### How to set up

1. Press **Menu** to activate the menus and select *Projector Control* → *Network*.

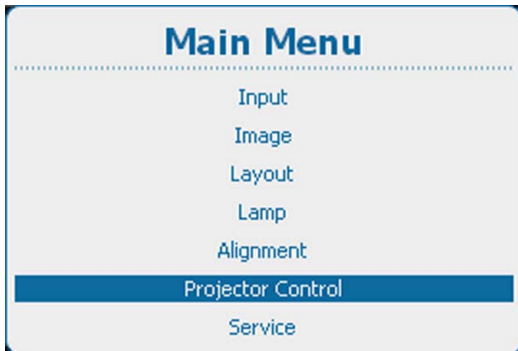


Image 13-26  
Main menu, projector control

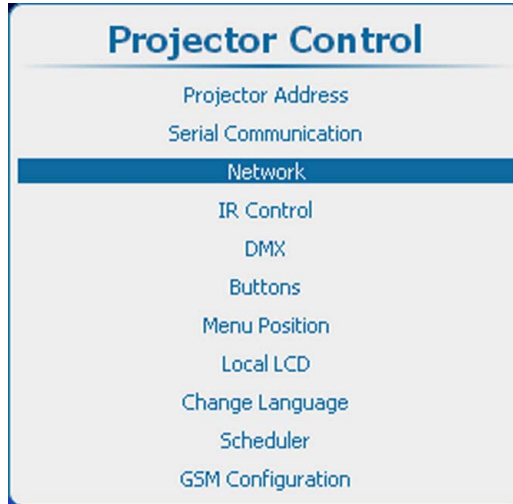


Image 13-27  
Projector control, network



Image 13-28  
Network, default gateway

2. Use the **▲** or **▼** key to select *Default Gateway* under *Wired* and press **ENTER** to activate the input box.



Image 13-29  
Default Gateway, input

- Use the ▲ or ▼ key to change the selected character.  
Use the ◀ or ▶ key to select another character.

**Note:** Digits can be entered with the digit keys on the remote control or the local keypad. When a digit is entered in that way, the next character will be selected automatically.

### 13.5.6 Wireless network activation



Can only be used with a wireless network module installed.

#### What can be done ?

Before a wireless network can be used, the status must be set to On.

#### How to activate

- Press **Menu** to activate the menus and select *Projector Control* → *Network* → *Wireless setup*.

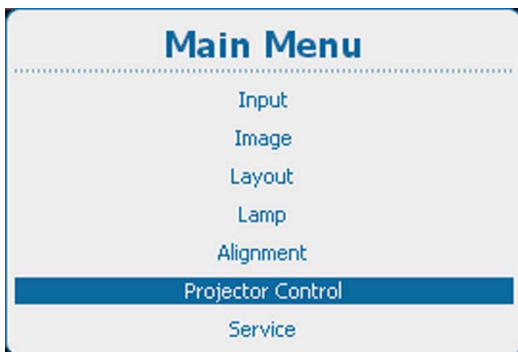


Image 13-30  
Main menu, projector control

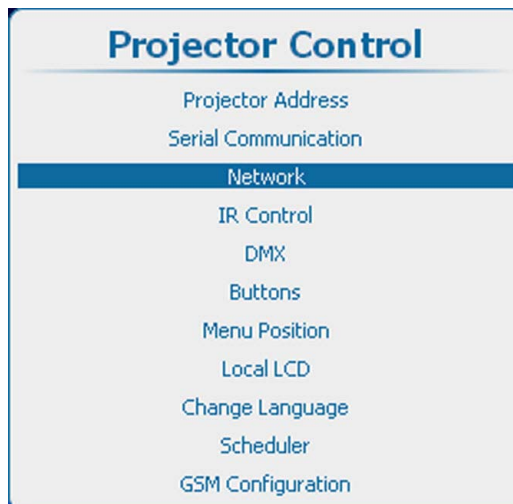


Image 13-31  
Projector control, network



Image 13-32  
Network, wireless

2. Press **ENTER** to select.

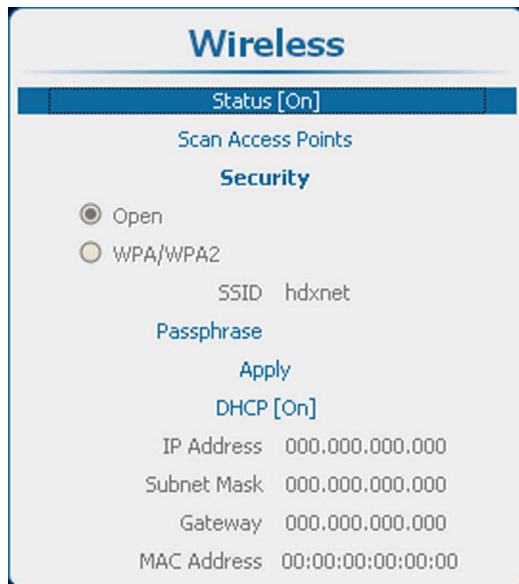


Image 13-33  
Wireless, status

3. Press **ENTER** to toggle the status between *[Off]* and *[On]*.

### 13.5.7 Wireless access points selection and setup



These menu items are only accessible when wireless network status is set to **[on]**.

---

#### Scan for access points

1. Select *Scan access points* and press **ENTER** to start the scan.

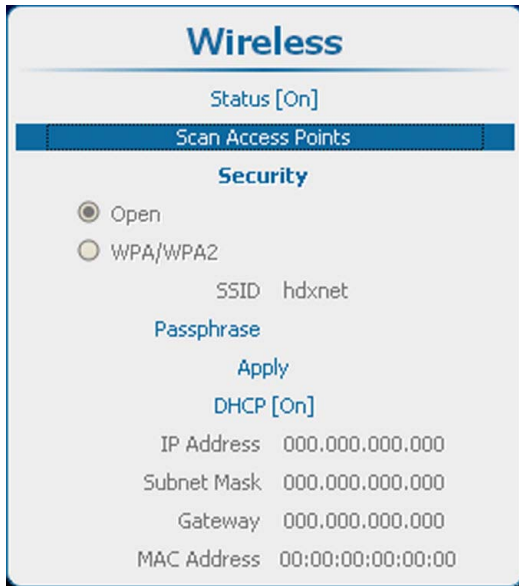


Image 13-34  
Scan access points

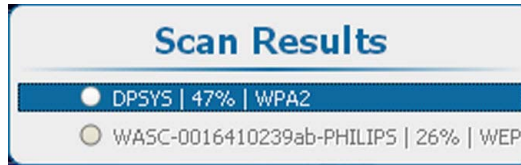


Image 13-35  
Scan access points, results

2. Use the ▲ or ▼ key to select the desired access point and press **ENTER** to activate.

The security type of the network is indicated with the radio button in front of *Open* or *WPA/WPA2*. The network name is also indicated next to *SSID*.

Note : WEP is not supported.

### Access to a wireless secured access point

1. Use the ▲ or ▼ key to select *Passphrase*.

For a secured network, a passphrase should be entered before getting access to the wireless network.

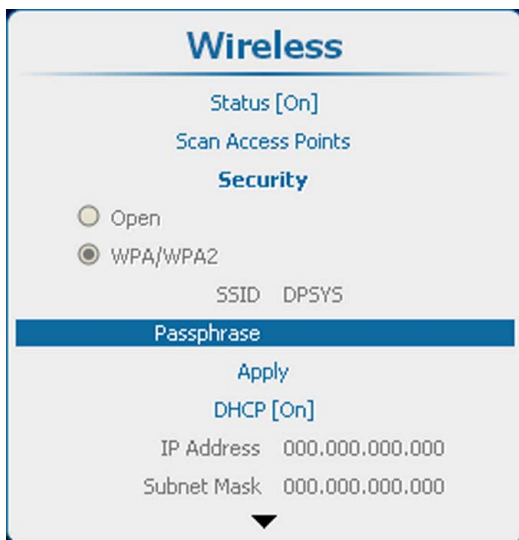


Image 13-36  
Passphrase, selection

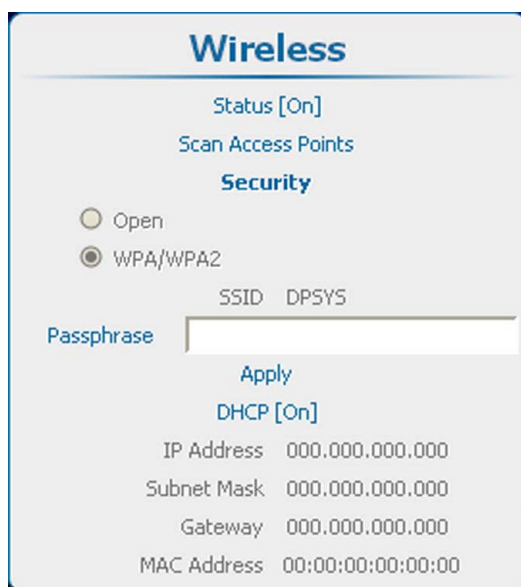


Image 13-37  
Passphrase, entry

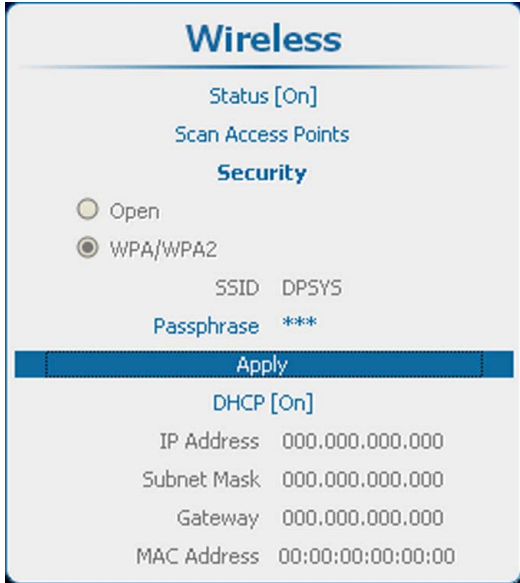


Image 13-38  
Open network connection

2. Press **ENTER** to activate the input field.
3. Enter the passphrase. The input is case sensitive. Press **ENTER** to finish the input of the passphrase.
4. Use the **▲** or **▼** key to select Apply and press **ENTER** to open the network connection.  
An IP address can now be obtained via DHCP or a fixed IP address can be setup.

### 13.5.8 Wireless DHCP set up



Can only be used with a wireless network module installed.

#### How to set up

1. Press **Menu** to activate the menus and select *Projector Control* → *Network* → *Wireless Setup* .

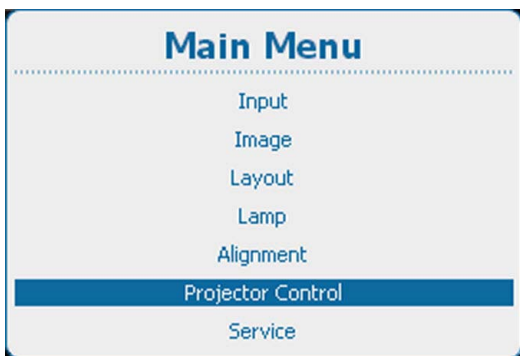


Image 13-39  
Main menu, projector control

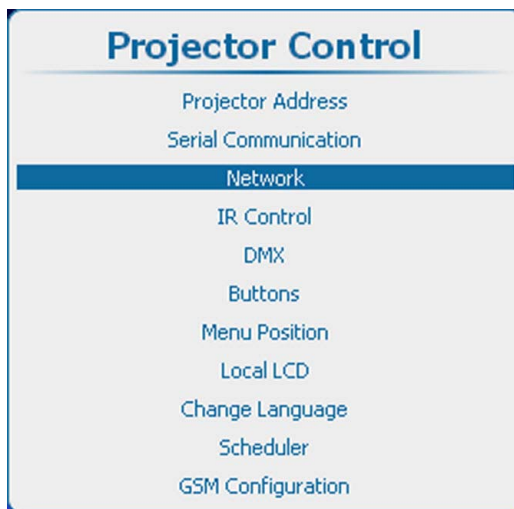


Image 13-40  
Projector control, network





Image 13-41  
Network, wireless

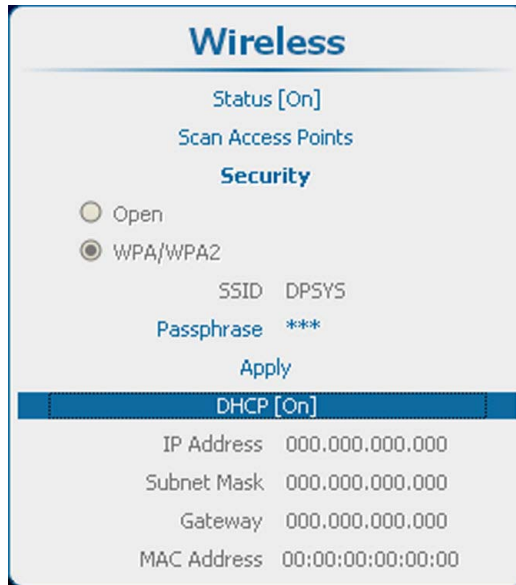


Image 13-42  
Wireless, DHCP

2. Press **ENTER** to open the *Wireless* menu.
3. Use the **▲** or **▼** key to select *DHCP* and press **ENTER** to toggle between *[On]* or *[Off]*.  
*[On]* : Wireless DHCP is activated. An automatic IP address is assigned.  
*[Off]* : Wireless DHCP is deactivated. A fixed address must be used.

### 13.5.9 Wireless fixed IP address set up



Can only be used with a wireless network module installed.

#### How to set up

1. Press **Menu** to activate the menus and select *Projector Control* → *Network* → *Wireless Setup*.

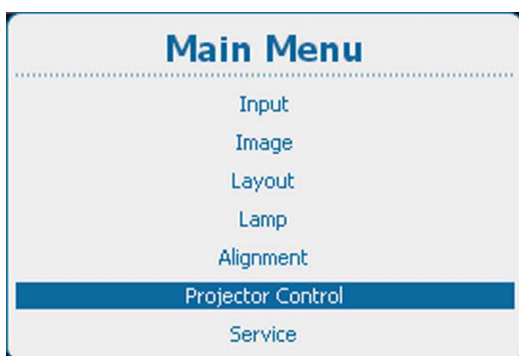


Image 13-43  
Main menu, projector control

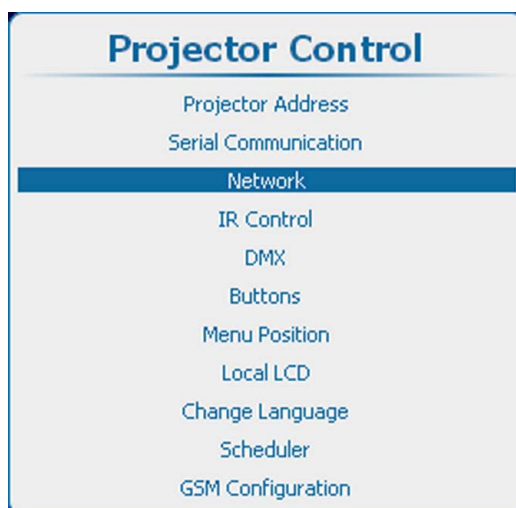


Image 13-44  
Projector control, network



Image 13-45  
Network, wireless



Image 13-46  
Network, wireless

2. Use the ▲ or ▼ key to select *IP Address* and press **ENTER** to activate the input box.

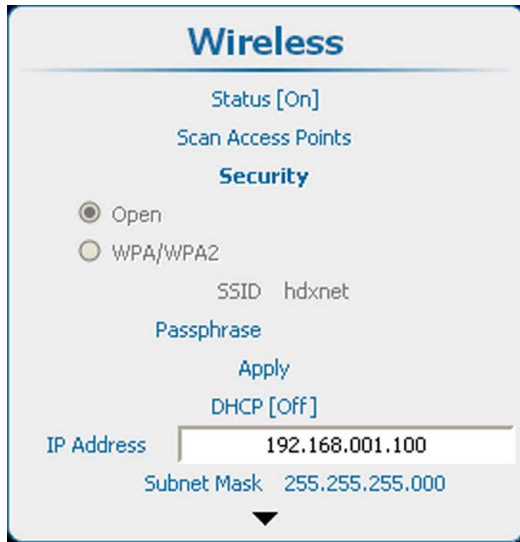


Image 13-47  
Wireless IP address input

3. Press **ENTER** to open the *Wireless* menu.

4. Use the ▲ or ▼ key to change the selected character.  
Use the ◀ or ▶ key to select another character.

**Note:** *Digits can be entered with the digit keys on the remote control or the local keypad. When a digit is entered in that way, the next character will be selected automatically.*

### 13.5.10 Wireless subnet mask set up



Can only be used with a wireless network module installed.



Subnet for *Wired* and *Wifi* must be different !

#### How to set up

1. Press **Menu** to activate the menus and select *Projector Control* → *Network* → *Wireless Setup*.

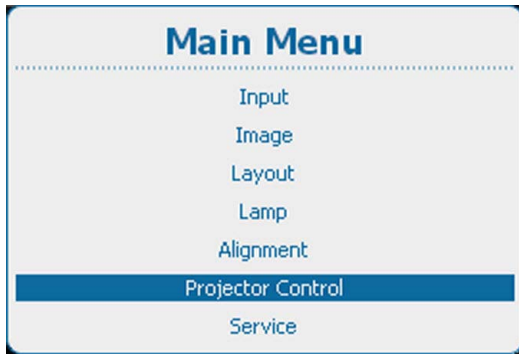


Image 13-48  
Main menu, projector control



Image 13-49  
Projector control, network



Image 13-50  
Network, wireless



Image 13-51  
Network, wireless Subnet Mask

2. Press **ENTER** to open the *Wireless* menu.
3. Use the **▲** or **▼** key to select *Subnet Mask* and press **ENTER** to activate the input box.



Image 13-52  
Wireless Subnet Mask, input

- Use the ▲ or ▼ key to change the selected character.  
Use the ◀ or ▶ key to select another character.

**Note:** Digits can be entered with the digit keys on the remote control or the local keypad. When a digit is entered in that way, the next character will be selected automatically.

### 13.5.11 Wireless default gateway set up



Can only be used with a wireless network module installed.

#### How to set up

- Press **Menu** to activate the menus and select *Projector Control* → *Network* → *Wireless Setup*.

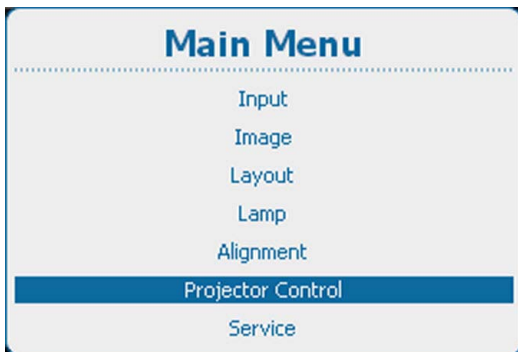


Image 13-53  
Main menu, projector control

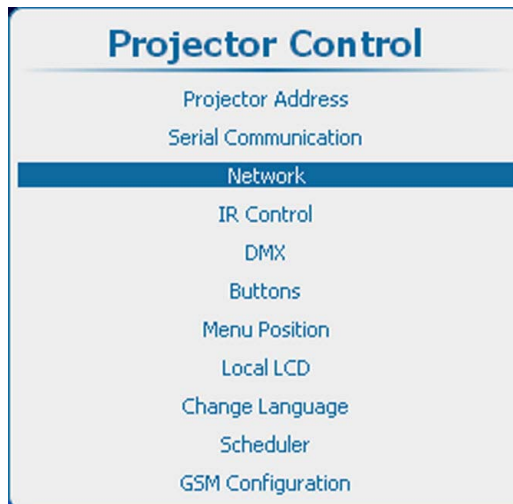


Image 13-54  
Projector control, network



Image 13-55  
Network, wireless



Image 13-56  
Wireless default gateway

2. Press **ENTER** to open the *Wireless* menu.
3. Use the **▲** or **▼** key to select *Subnet Mask* and press **ENTER** to activate the input box.



Image 13-57  
Wireless default gateway, input

4. Use the **▲** or **▼** key to change the selected character.  
Use the **◀** or **▶** key to select another character.  
**Note:** *Digits can be entered with the digit keys on the remote control or the local keypad. When a digit is entered in that way, the next character will be selected automatically.*

## 13.6 IR Control switching

### What can be done ?

Each IR receiver inside the projector can be activated or deactivated. When an IR receiver is deactivated, no IR signal sent to this IR receiver will be processed.

### How to activate or deactivate

1. Press **Menu** to activate the menus and select *Projector Control* → *IR control*.

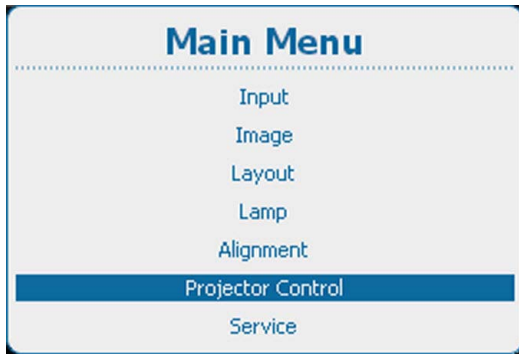


Image 13-58  
Main menu, projector control



Image 13-59  
Projector control, IR control

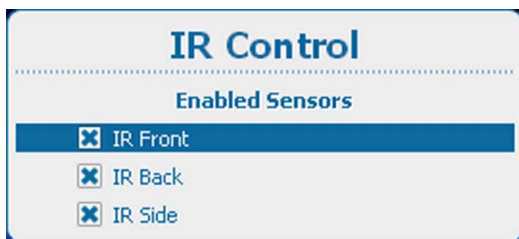


Image 13-60  
IR control

2. Use the ▲ or ▼ key to select the desired IR control and press **ENTER** to check checkbox.  
Checked : IR receiver is enabled and can receive and process commands sent by the remote control.  
Not checked : IR receiver is disabled and not receive any command.

---

## 13.7 DMX

### Overview

- DMX address
- DMX universe
- DMX mode
- Art-Net DMX
- Front XLR output voltage control
- Monitor
- DMX Shutdown
- DMX Shutdown retarding time

### About the ways to control the projector via DMX

With a standard DMX cable equipped with XLR connector DMX signals can be connected to the DMX In port on the communicator interface. The DMX out can be used to create a chain of DMX devices. One universe can control up to 512 channels.

If you are using a DMX console and other automated lighting products compatible with Art-Net, the Ethernet network can serve as the link for DMX control. All DMX controls can be sent over the Ethernet cable. Multiple universes are possible.

#### 13.7.1 DMX address

##### What should be done ?

Before a projector can execute DMX commands, a unique address, called DMX address, should be given to the projector. This address can vary from 1 to 512.

## How to set the DMX address

1. Press **Menu** to activate the menus and select *Projector Control* → *DMX* → *Address*.

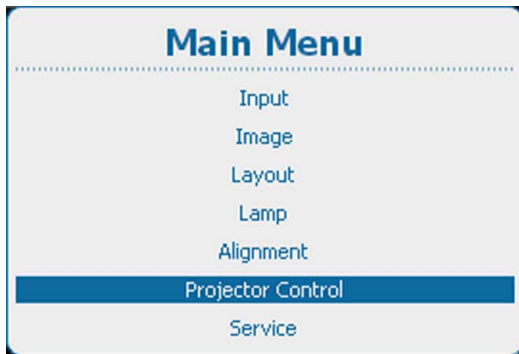


Image 13-61  
Main menu, projector control

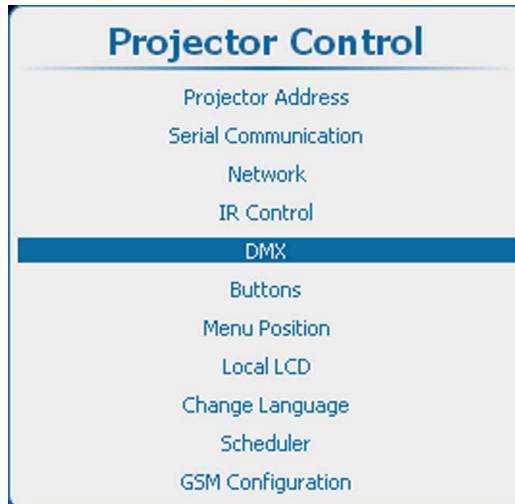


Image 13-62  
Projector control, DMX

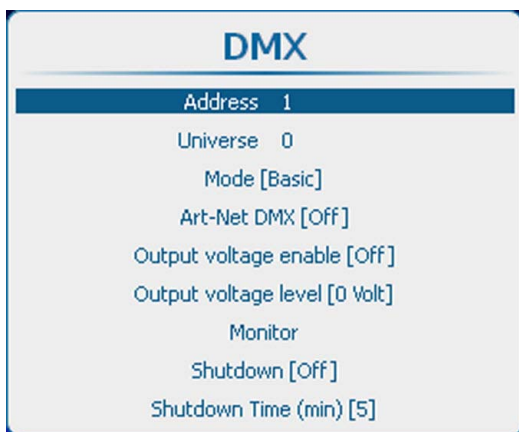


Image 13-63  
DMX, address

2. Press **ENTER** to select.

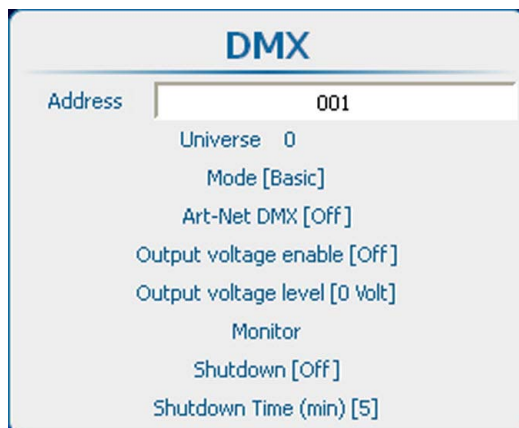


Image 13-64  
DMX address

3. Use the **▲** or **▼** key to change the selected character.  
Use the **◀** or **▶** key to select another character.

**Note:** *Digits can be entered with the digit keys on the remote control or the local keypad. When a digit is entered in that way, the next character will be selected automatically.*

### 13.7.2 DMX universe

#### What can be done ?

Depending on the DMX mode, one DMX universe can contain a different number of projectors. E.g. DMX mode = basic, the DMX universe can contain up to 256 projectors

Universes are only meaningful for Art-Net applications as only there multiple universes can be addressed.

#### How to set a DMX universe

1. Press **Menu** to activate the menus and select *Projector Control* → *DMX* → *Universe*.

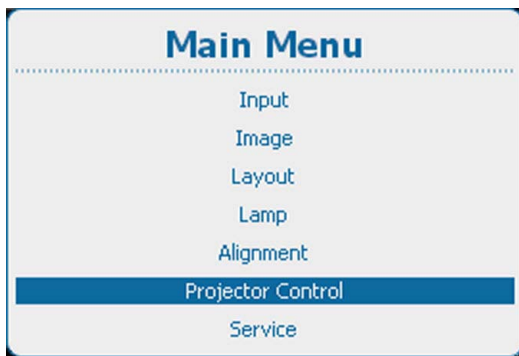


Image 13-65  
Main menu, projector control

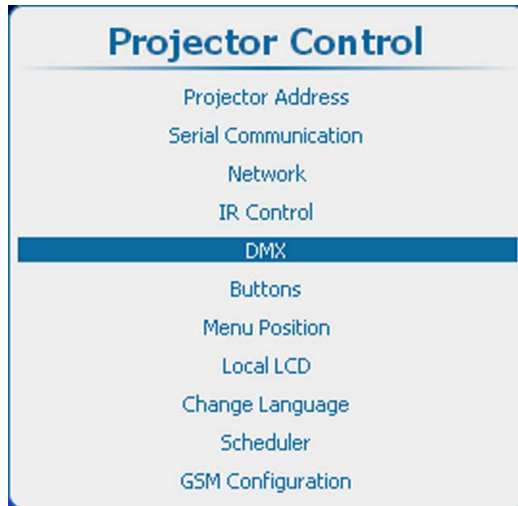


Image 13-66  
Projector control, DMX

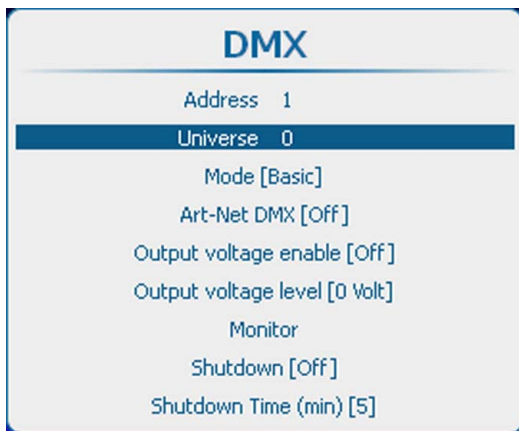


Image 13-67  
DMX, universe

2. Press **ENTER** to select.



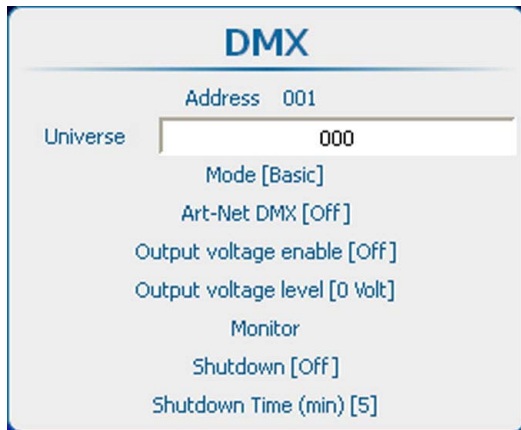


Image 13-68  
DMX universe

- Use the ▲ or ▼ key to change the selected character.  
Use the ◀ or ▶ key to select another character.

**Note:** Digits can be entered with the digit keys on the remote control or the local keypad. When a digit is entered in that way, the next character will be selected automatically.

### 13.7.3 DMX mode

#### What can be done ?

3 modes for DMX are available:

- Basic which has currently 2 channels implemented.
- Extended which has currently 10 channels implemented
- Full which has currently 9 channels implemented and a 10th free channel.

Depending on the DMX application the correct mode has to be selected.

#### How to set the mode

- Press **Menu** to activate the menus and select *Projector Control* → *DMX* → *Universe*.

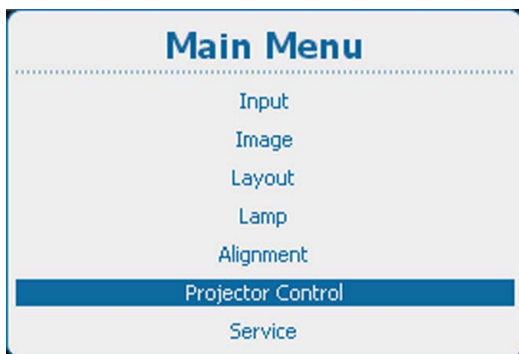


Image 13-69  
Main menu, projector control

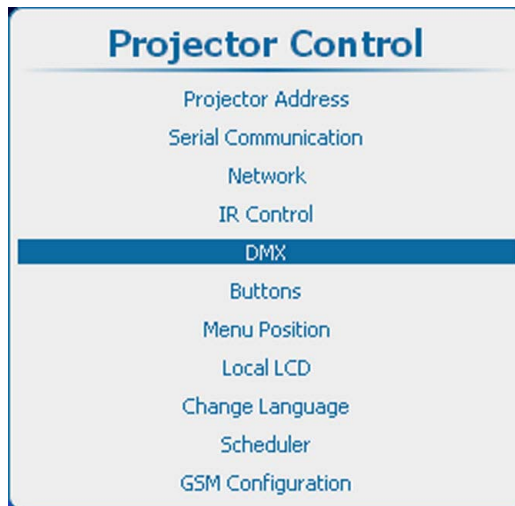


Image 13-70  
Projector control, DMX

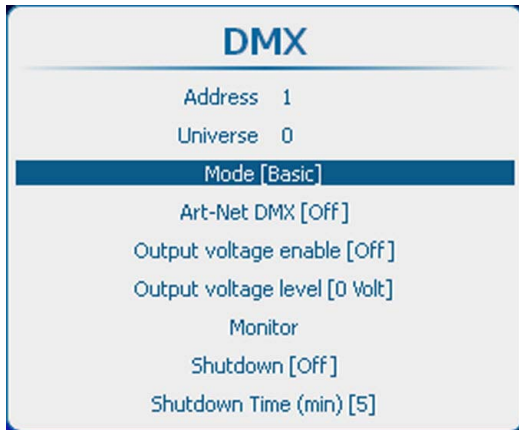


Image 13-71  
DMX mode

2. Press **ENTER** to toggle between [Basic], [Extended] or [Full].

### 13.7.4 Art-Net DMX

#### What can be done ?

DMX can be sent via Ethernet to the projector. This function can be enabled or disabled.

Art-Net DMX [On] : DMX via Ethernet is enabled.

Art-Net DMX [Off] : DMX via Ethernet is disabled.

#### How to toggle

1. Press **Menu** to activate the menus and select *Projector Control* → *DMX* → *Art-Net DMX*.

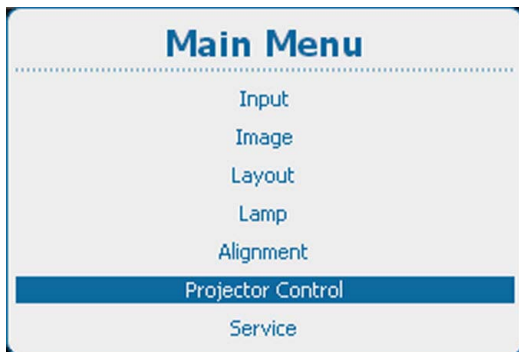


Image 13-72  
Main menu, projector control

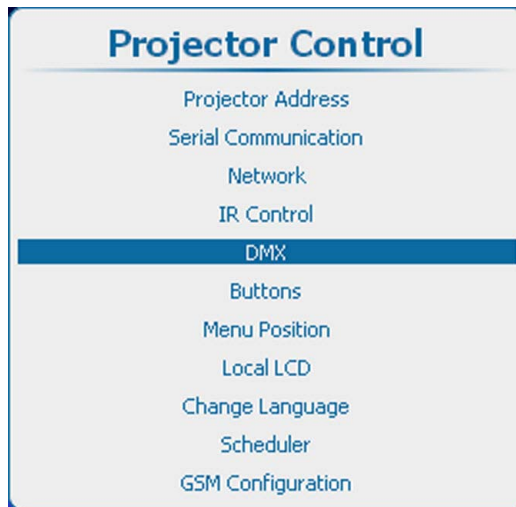


Image 13-73  
Projector control, DMX

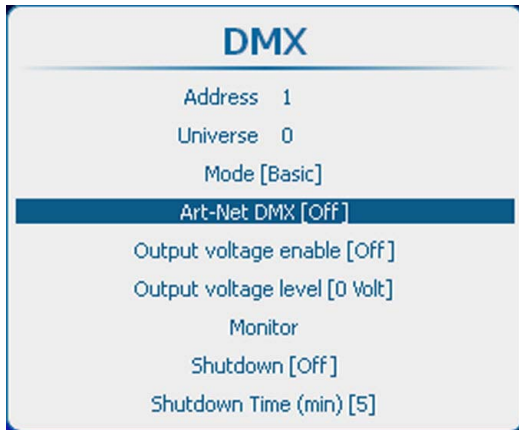


Image 13-74  
DMX Art-Net activation

2. Press **ENTER** to toggle between *[On]* and *[Off]*.

### 13.7.5 Front XLR output voltage control

#### What can be done ?

The output voltage on the front XLR connector can be enabled or disabled.

The output voltage level can be set to 0V, 9V, 12V or 24V.

DMX Art-Net can also enable the output voltage on the front XLR connector. To avoid that per accident a voltage is activated via DMX Art-Net, set level to 0 V

#### How to enable or disable

1. Press **Menu** to activate the menus and select *Projector Control* → *DMX* → *Output voltage enable*.

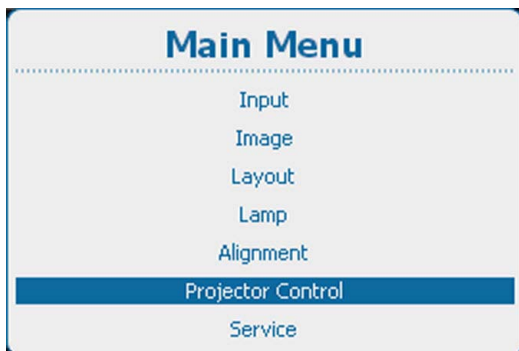


Image 13-75  
Main menu, projector control

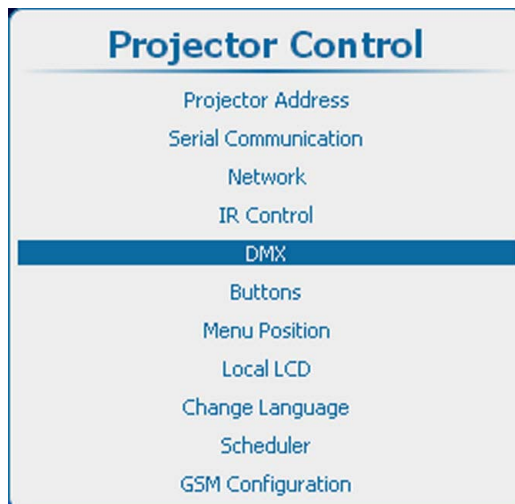


Image 13-76  
Projector control, DMX

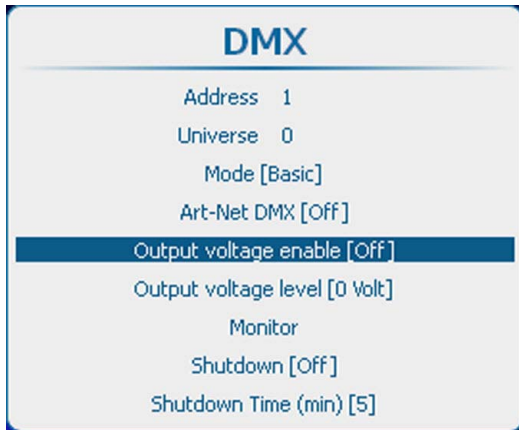


Image 13-77  
Front XLR Output voltage enable

2. Press **ENTER** to toggle between [On] and [Off].  
[On] : Front XLR Output voltage enabled.  
[Off] : Front XLR Output voltage disabled.

### Output voltage level setup

1. Press **Menu** to activate the menus and select *Projector Control* → *DMX* → *Output voltage level*.

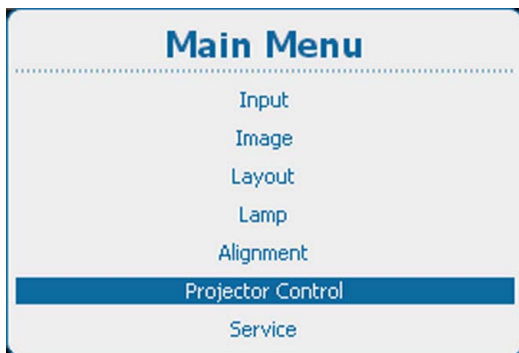


Image 13-78  
Main menu, projector control

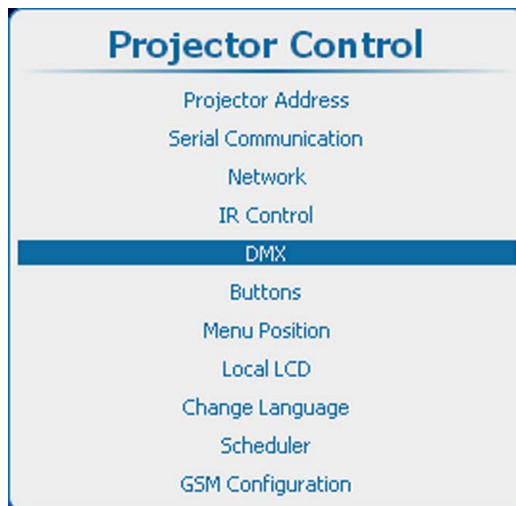


Image 13-79  
Projector control, DMX

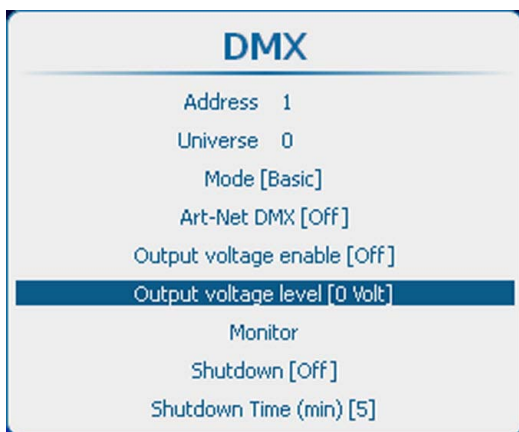


Image 13-80  
Front XLR output voltage level

2. Press **ENTER** to toggle between [0 Volt], [9 Volt], [12 Volt] and [24 Volt].

### 13.7.6 Monitor

#### What can be done ?

If a DMX device is connected, the settings per channel can be displayed in an on screen menu.

#### How to start up the monitoring

1. Press **Menu** to activate the menus and select *Projector Control* → *DMX* → *Monitor*.

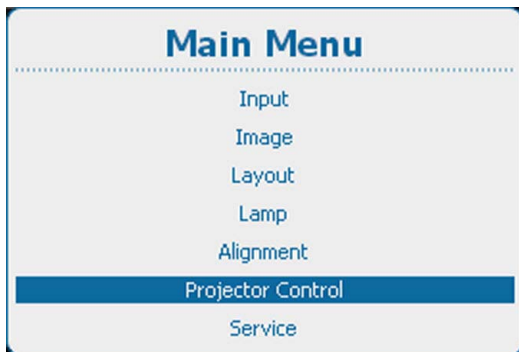


Image 13-81  
Main menu, projector control

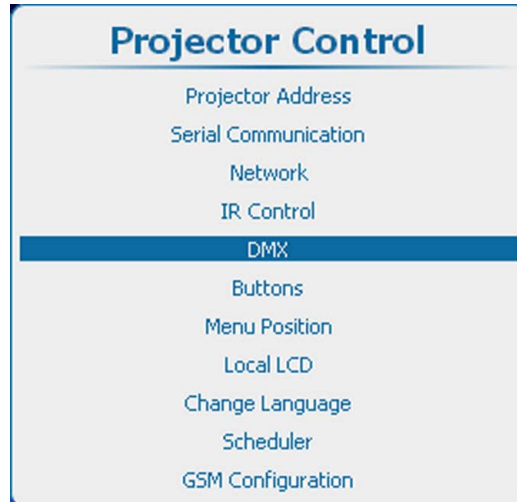


Image 13-82  
Projector control, DMX

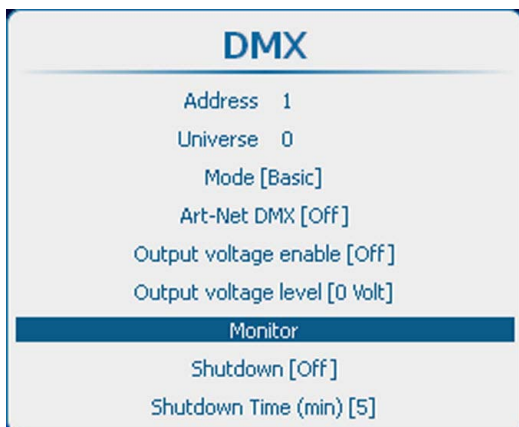


Image 13-83  
DMX monitor

2. Press **ENTER** to open the overview list.

Channel	Function	Value
1	Intensity	255
2	Brightness	128
3	Contrast	128
4	Input selection	88
5	Function select	0
6	Motor Go >>	0
7	Motor Go <<	0
8	Free	0
9	Lamp Power	0
10	Free	0

Image 13-84  
DMX overview list

### 13.7.7 DMX Shutdown

#### What can be done?

Projector can be forced to go in shutdown after a certain retarding time when no DMX signals are available.

#### How to activate/deactivate

1. Press **Menu** to activate the menus and select *Projector Control* → *DMX* → *Shutdown*.

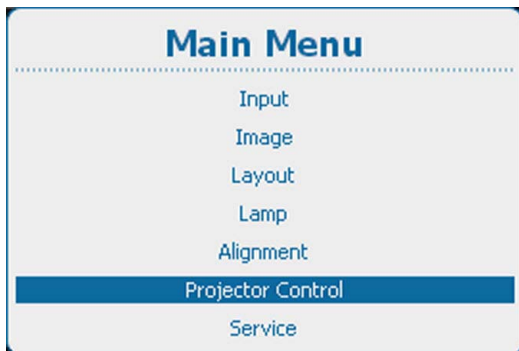


Image 13-85  
Main menu, projector control

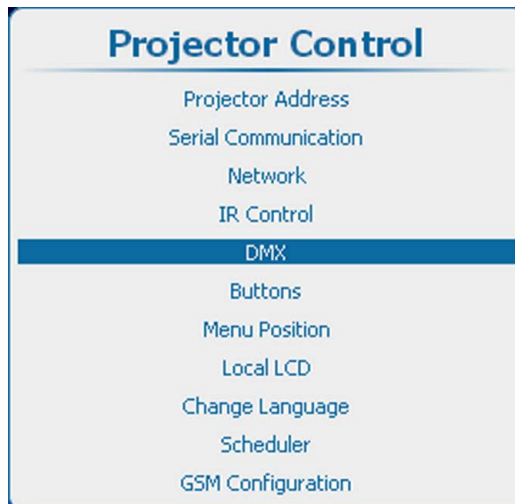


Image 13-86  
Projector control, DMX

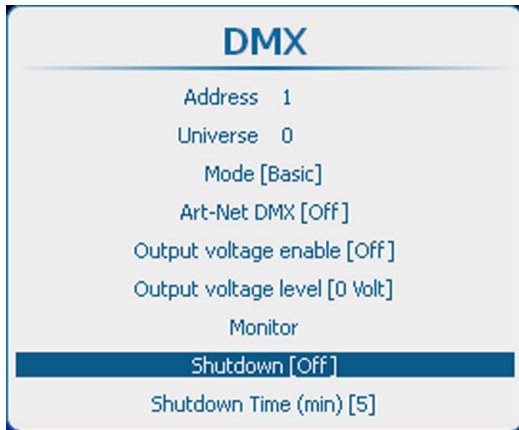


Image 13-87  
DMX shutdown

2. Press **ENTER** to toggle between *[On]* and *[Off]*.  
*[On]* : projector goes in shutdown after a certain retarding time.  
*[Off]* : projector does not go in shutdown.

### 13.7.8 DMX Shutdown retarding time

#### About the shutdown retarding time

The retarding time is the time between no DMX is detected and the moment that the projector shuts down.

#### How to set the retarding time

1. Press **Menu** to activate the menus and select *Projector Control* → *DMX* → *Shutdown Time*.

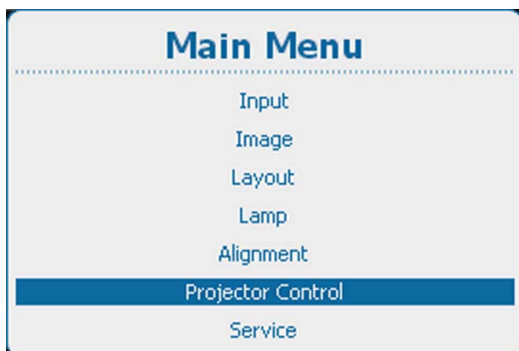


Image 13-88  
Main menu, projector control

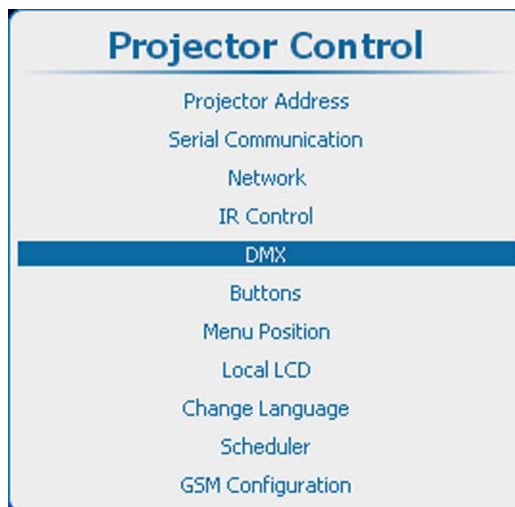


Image 13-89  
Projector control, DMX

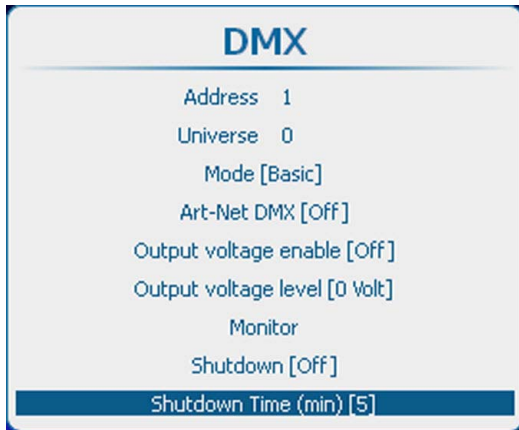


Image 13-90  
DMX shutdown time

2. Press **ENTER** to toggle between [1], [3], [5] and [10] minutes.

## 13.8 Buttons

---

### Overview

- Standby button
- Shortcut keys

### 13.8.1 Standby button

#### What can be done ?

When going to standby by pressing the standby button, the following can happen:

- Only lamp will be switched off
- Lamp will be switched off and projector electronics will be powered down after an *after cool* period (ECO standby)

In ECO standby only the microcontroller, communication interface and local (or remote) control are operational. All other electronics are powered down.

#### How to set

1. Press **Menu** to activate the menus and select *Projector Control* → *Buttons* → *Standby*.

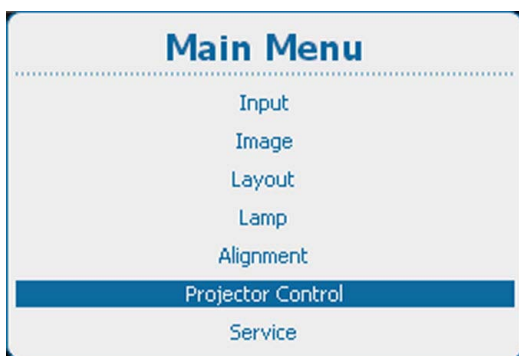


Image 13-91  
Main menu, projector control

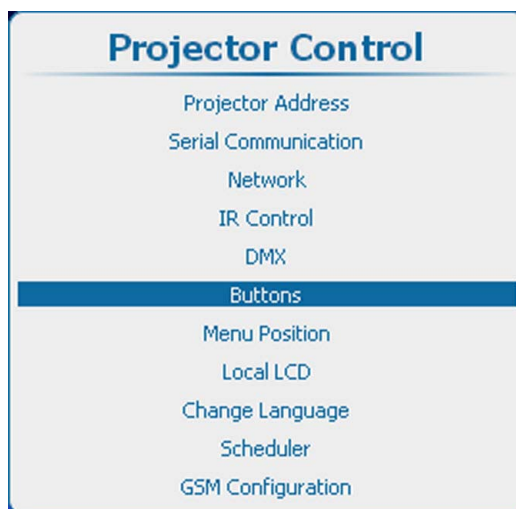


Image 13-92  
Projector control, buttons





Image 13-93  
Buttons, standby

2. Press **ENTER** to toggle between *[Lamp only]* and *[Lamp and Power]*.

Lamp only : only lamp will be switched off when Standby is pressed. Other electronics remain powered.

Lamp and Power : lamp will be switched off and projector will be powered down.

## 13.8.2 Shortcut keys

### What can be done?

An overview of the shortcut allocations with the corresponding menu is given. Those printed in bold are allocated.

The allocated shortcut keys can be cleared within this menu.

For the creation of a short cut key, see "Shortcut keys to the menus", page 69

### How to clear a shortcut key

1. Press **Menu** to activate the menus and select *Projector Control* → *Buttons* → *Shortcut keys*.

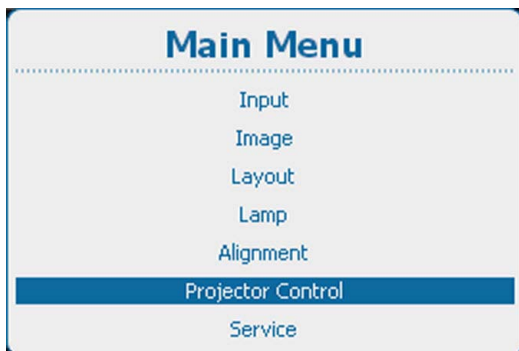


Image 13-94  
Main menu, projector control



Image 13-95  
Projector control, buttons



Image 13-96  
Buttons, shortcut keys

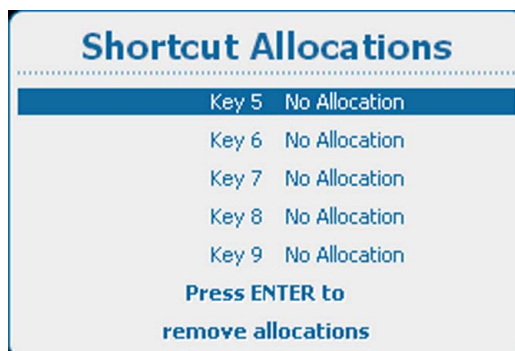


Image 13-97  
Shortcut allocations

2. Use the ▲ or ▼ key to select the desired key and press **ENTER** to remove the allocation.

## 13.9 Menu position

### What is possible?

The on screen menu and the bar scale can be positioned on different places on the screen.

The following positions are possible for both

- Right-top
- Right-mid
- Right-bottom
- Mid-top
- Mid-mid
- Mid-bottom
- Left-top
- Left-mid
- Left-bottom

### How to change the position

1. Press **Menu** to activate the menus and select *Projector Control* → *Menu Position*.

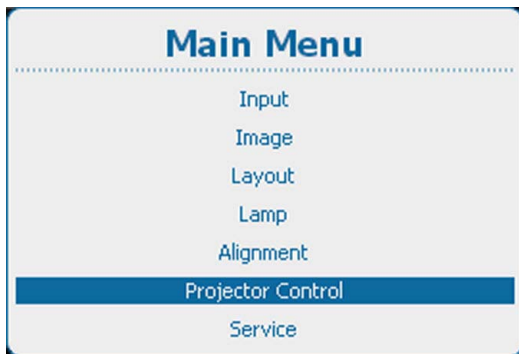


Image 13-98  
Main menu, projector control

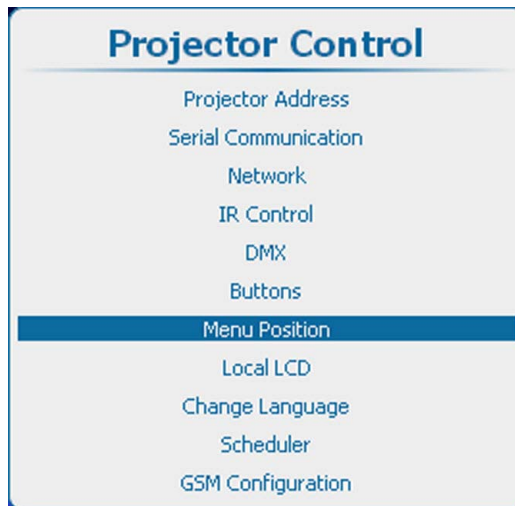


Image 13-99  
Projector control, menu position



Image 13-100  
Menu position

2. Use the ▲ or ▼ key to select *Menu position* or *Barscale position* and press **ENTER** to toggle the different possibilities.

## 13.10 Local LCD

### What is possible ?

The back light of the local LCD can be adapted to the needs of the environment.

A time out for the local LCD can be set. If there is nothing done on the local LCD, it can go out after a time out.

### How to set up

1. Press **Menu** to activate the menus and select *Projector Control* → *Local LCD*.

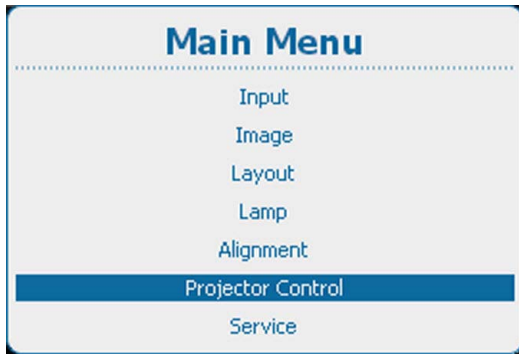


Image 13-101  
Main menu, projector control



Image 13-102  
Projector control, Local LCD

2. Use the ▲ or ▼ key to select *Back Light*.



Image 13-103  
Local LCD, back light

3. Use the ◀ or ▶ key to change the back lighting of the local LCD panel.  
4. Use the ▲ or ▼ key to select *Time out*.



Image 13-104  
Local LCD, time out

5. Press **ENTER** to toggle between [Off], [10], [30], [60] or [120].

[Off] : LCD panel remains always on.

a value : LCD shut down in x seconds.

## 13.11 Language selection

### What can be done?

The user can change the language of the on screen menus and the local display menus to one of the available languages.

The following languages are available:

- English
- French
- German
- Spanish
- Portuguese
- Japanese
- Chinese
- Korean
- Dutch

All available languages are indicated in the language of the country. The current active language is indicated by checked radio button.

### How to change the language

1. Press **Menu** to activate the menus and select *Projector Control* → *Change Language*.

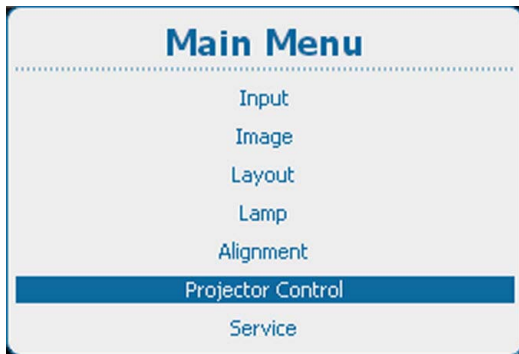


Image 13-105  
Main menu, projector control

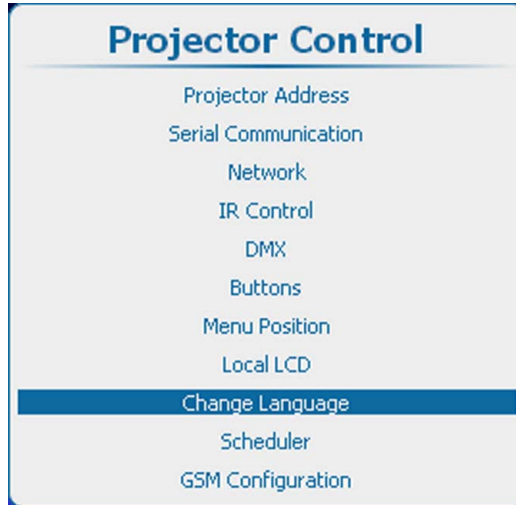


Image 13-106  
Projector control, change language



Image 13-107  
Language selection

2. Use the **▲** or **▼** key to select the desired language and press **ENTER** to activate.

The radio button before the active language is checked. The menu content is changed to the new language.

## 13.12 Scheduler

---

### About the scheduler

The scheduler allows to start up different tasks at a given time which can control the screen layout and the status of the lamp. These tasks can be scheduled in time with a certain recurrence and occurrence. Multiple tasks can be added to the list of tasks and all these tasks will be controlled by the scheduler.

A simple example of a schedule:

- task1 : load layout 1 and switch on lamp at the start of the day
- task2: switch to layout 2 at a certain hour. No changes for the lamp.
- task3: lamp off at the end of the day.

Follow the next topics to create, edit or delete a task.

## Overview

- Add a task to the list
- Edit a task
- Delete task
- Scheduler, on or off

### 13.12.1 Add a task to the list

#### How to add

1. Press **Menu** to activate the menus and select *Projector Control* → *Scheduler* → *Add task*.

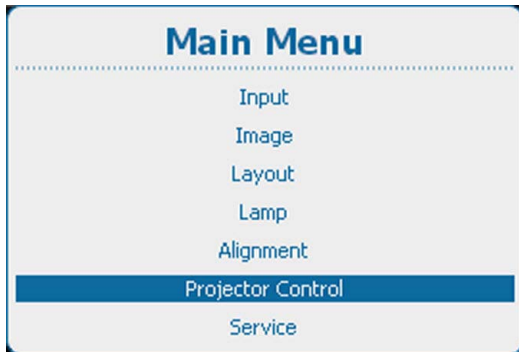


Image 13-108  
Main menu, projector control

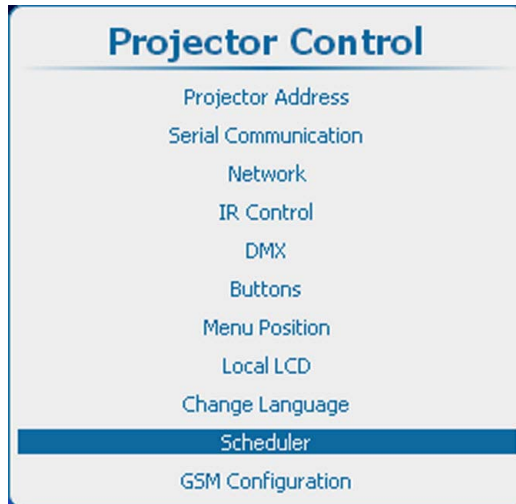


Image 13-109  
Projector control, scheduler

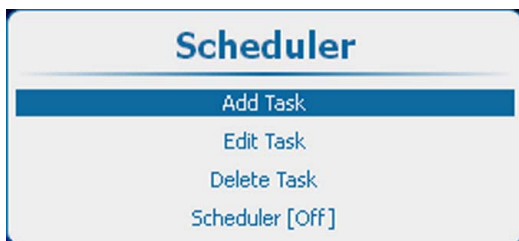


Image 13-110  
Scheduler, add task

2. Press **ENTER** to open the task creation window. The start date window is selected. Use the **▲** or **▼** key to jump to the next item in the setup. When all items are correctly filled out, select *Apply* and press **ENTER** to create the task.

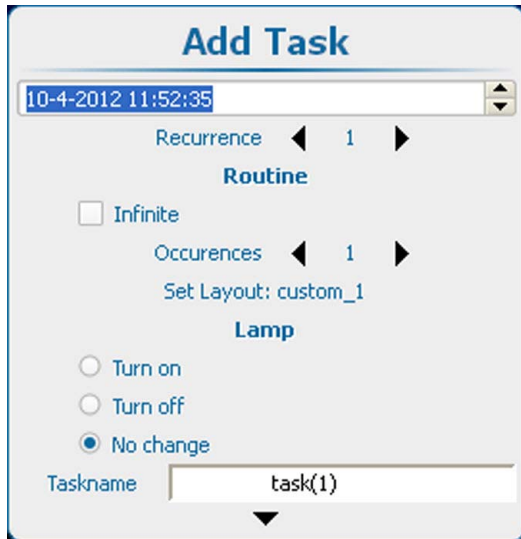


Image 13-111  
Add task, setup

### Start date and time

1. When selected, press **ENTER** to select the day.
2. Use the **▲** or **▼** key to change the current setting.  
Use the **◀** or **▶** key to jump to the next part of the date and time setting.

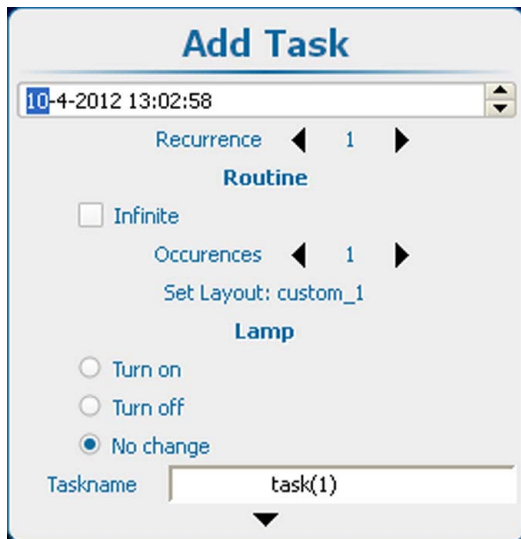


Image 13-112  
Time setup

3. Select *Recurrence* and press **ENTER**;  
Use the **◀** or **▶** key to change the recurrence.



Image 13-113  
Recurrence setup

Recurrence : the time between two starts of the same task. The value can be changed between 1 and 99.

- 1 Starts every day
- 2 Starts every 2 days
- 3 Starts every 3 days
- ...
- 7 Starts every week

### Routine setup, infinite loop

To repeat the task with a given sequence again and again, check the check box in front of *Infinite*.

### Routine setup, occurrences

For a limited number of loops, set up the occurrences:

1. Select *Occurrence* and press **ENTER**.
2. Use the ◀ or ▶ key to change the occurrence.



Image 13-114  
Occurrence setup

Occurrence : the number of loops that will take place as set in the recurrence.

E.g; an occurrence of 2 with a recurrence of 3 means that the schedule will be executed at the start date, start date + 3 and due to the occurrence (=2) also at start date + 6.

### Layout selection

1. Select *Set layout* and press **ENTER**.

The *Load* layout menu opens with a list of the available layouts.

2. Use the ▲ or ▼ key to select the desired layout and press **ENTER** to link the layout to the task.



Image 13-115  
Link layout

### Lamp status

1. Select the desired lamp status and press **ENTER** to select.

The following lamp statuses are possible:

- Turn on : lamp will be switched on when the task is started.
- Turn off : lamp will be switched off when the task is started.
- No change : no changes to the lamp status when the task is started. The lamp remains in its current status.

### Task name

1. Select *Taskname* and press **ENTER** to edit the current proposed name.

2. Use the ◀ or ▶ key to select the desired character to change.

Use the ▲ or ▼ key to change that character.

**Note:** Extra characters can be added at the end of the current displayed characters.

### Creating the task

1. Select *Apply* and press **ENTER** to create the task.

The task is added to the list of tasks.

### 13.12.2 Edit a task

#### What can be done?

An existing task in the list of tasks can be edited and saved with the same name.

#### How to edit

1. Press **Menu** to activate the menus and select *Projector Control* → *Scheduler* → *Edit task*.

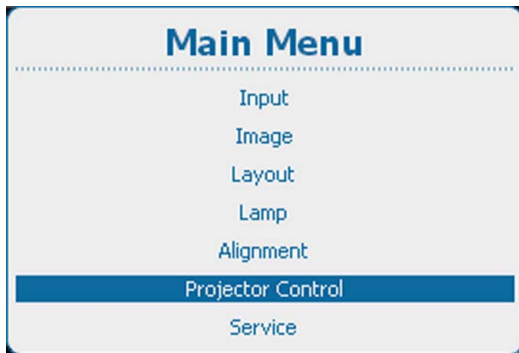


Image 13-116  
Main menu, projector control



Image 13-117  
Projector control, scheduler

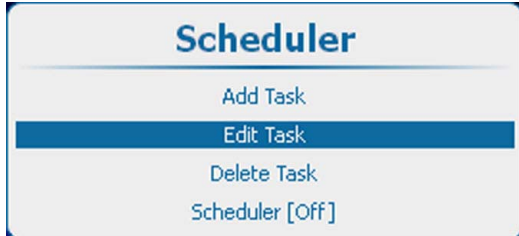


Image 13-118  
Scheduler, edit task

2. Press **ENTER** to open the task selection list.

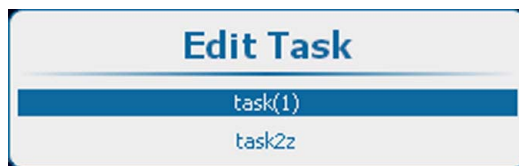


Image 13-119  
Task selection list

3. Use the **▲** or **▼** key to select the desired task and press **ENTER**



The edit task window opens.

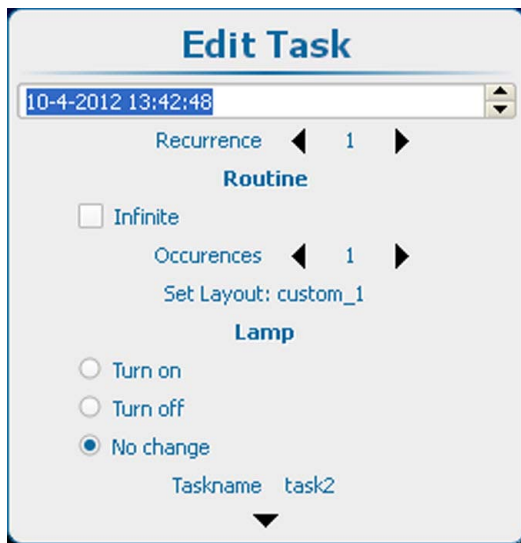


Image 13-120  
Edit task

The following items can be changed in the same way as creating a new task. For more info, see "Add a task to the list", page 249:

- Date and time
- Recurrence
- Routine
- Lamp status



Changing the name and applying the task will replace the selected task with the edited task with the new name.

### 13.12.3 Delete task

#### What can be done?

A task stored in the list of tasks can be deleted from that list.

#### How to delete

1. Press **Menu** to activate the menus and select *Projector Control* → *Scheduler* → *Delete task*.

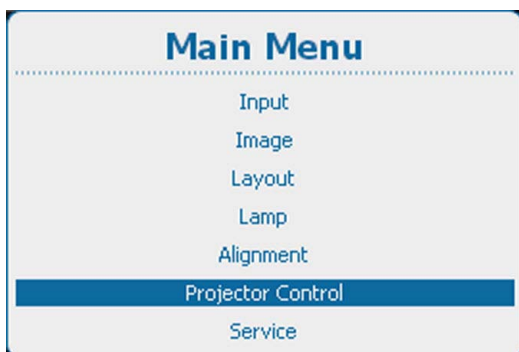


Image 13-121  
Main menu, projector control

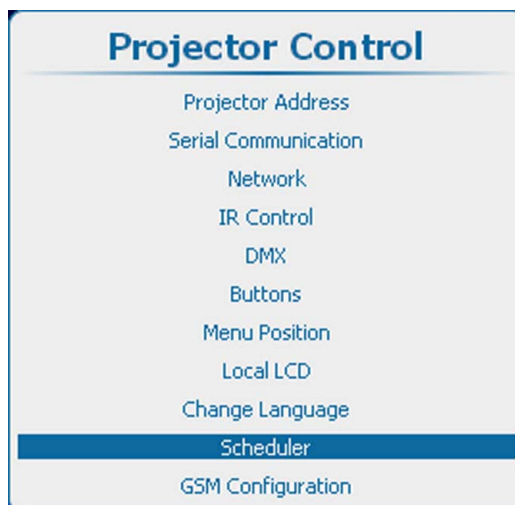


Image 13-122  
Projector control, scheduler

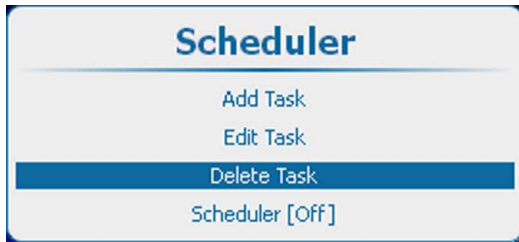


Image 13-123  
Scheduler, delete task

2. Press **ENTER** to open the list of tasks.

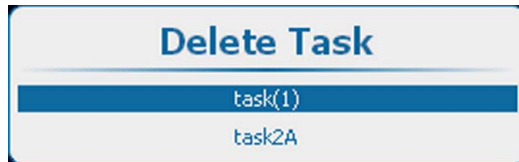


Image 13-124  
Delete task, list

3. Use the **▲** or **▼** key to select the task to delete and press **ENTER**.  
A confirmation window opens.

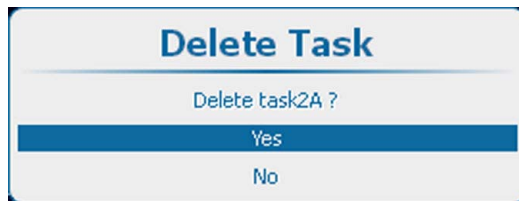


Image 13-125

4. Select **Yes** to delete the task.  
Select **No** to return without deleting the task.

### 13.12.4 Scheduler, on or off

#### What can be done?

The scheduler can be switched on or off.

When switched on, the tasks in the list will be executed on the given time.

#### How to toggle the scheduler

1. Press **Menu** to activate the menus and select *Projector Control* → *Scheduler* → *Scheduler [On]/[Off]*.

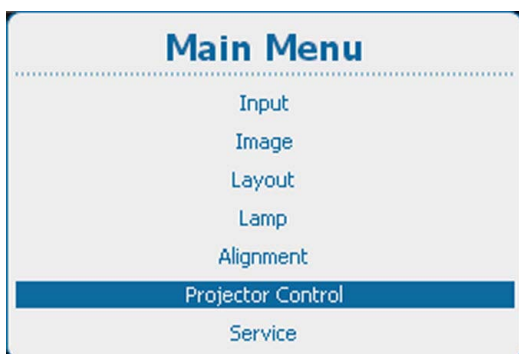


Image 13-126  
Main menu, projector control

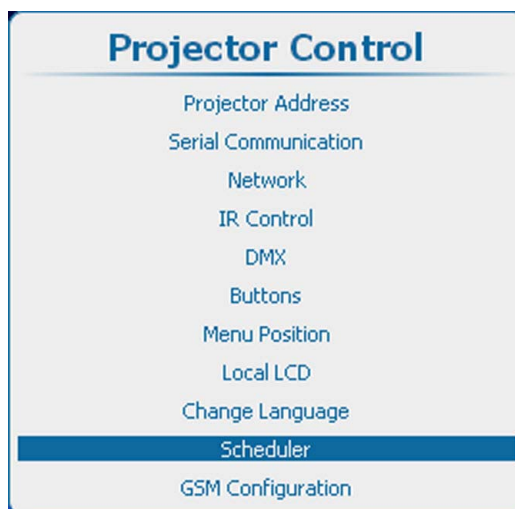


Image 13-127  
Projector control, scheduler

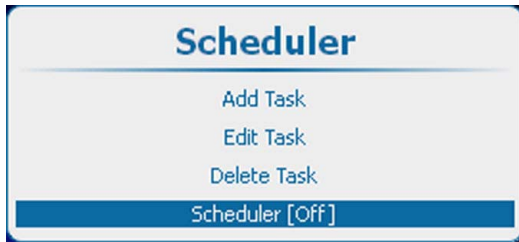


Image 13-128  
Scheduler, on or off

2. Press **ENTER** to toggle between *[On]* and *[Off]*

On Scheduler will execute the tasks in the list.

A schedule symbol is added at the left bottom corner of the local LCD panel ()

Off No tasks are executed

### 13.13 GSM Configuration, activation



Only possible when a GSM module with SIM card is installed in the projector.

#### What can be done ?

To configure the projector software with the installed SIM card, a correct PIN code (4digits) must be entered.



As the PIN code cannot be checked with the one on the SIM card, ensure to enter the correct PIN code.



When your SIM card is blocked, you have to remove the SIM card from the GSM module and to insert the SIM card in a mobile phone so that you can enter the PUK code to unblock the SIM card.

#### How to configure

1. Press **Menu** to activate the menus and select *Projector Control* → *GSM configuration* → *GSM pincode*.

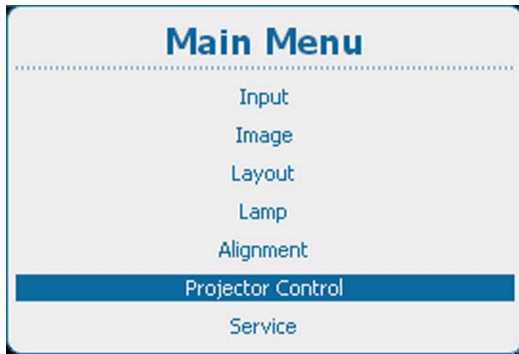


Image 13-129  
Main menu, projector control

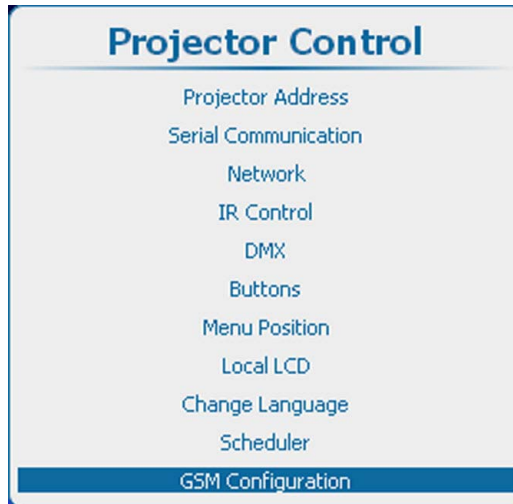


Image 13-130  
Projector control, GSM configuration



Image 13-131  
GSM configuration

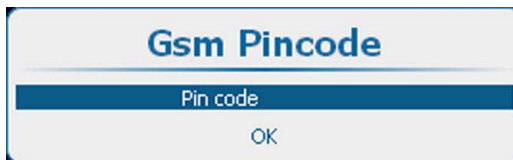


Image 13-132  
GSM pincode

2. Select *Pin code* and press **ENTER**.  
A PIN code input field appears.



Image 13-133  
Device configuration, PIN code

3. Enter the 4 digit PIN code corresponding with the mounted SIM card. Use the digit keys on the remote control or the local keypad. Each digit is replaced by an asterisks. Press **ENTER** when the 4 digits are entered.

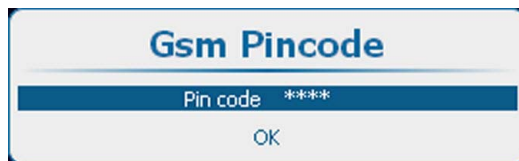


Image 13-134

4. Select *OK* and press **ENTER** to configure the software.

### Replacing a SIM card with a new one

1. Before removing the current mounted SIM card, select *Projector Control* → *GSM configuration* → *GSM pincode*

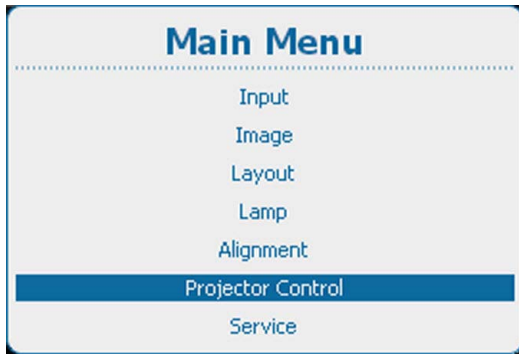


Image 13-135  
Main menu, projector control



Image 13-136  
Projector control, GSM configuration



Image 13-137  
GSM configuration, Pin code

2. Select *Pin code* with the current filled out code and press **ENTER** to clear the current code.

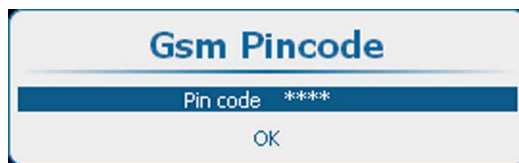


Image 13-138

3. Select *OK* and press **ENTER** to configure the software.
4. Proceed with the SIM card replacement and follow the configure procedure as described above.

## 13.14 GSM Configuration, subscription

### About SMS subscription

When subscribed for notifications, the projector will send out SMS messages when notifications occur with severity "Critical", "Error" or "Warning".

### How to subscribe via the OSD menu

1. Press **Menu** to activate the menus and select *Projector Control* → *GSM configuration* → *Sms subscriptions*.

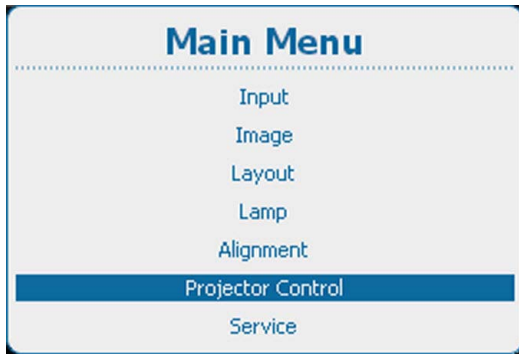


Image 13-139  
Main menu, projector control

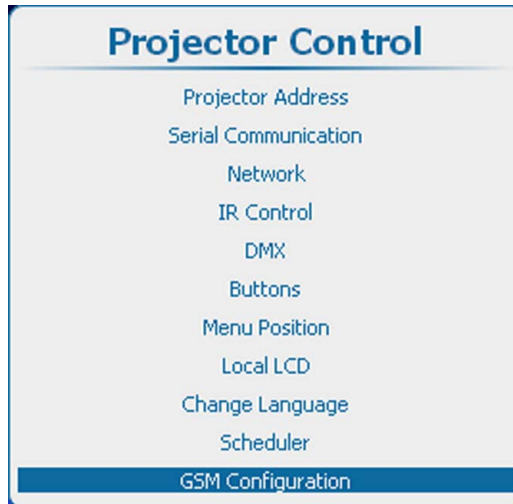


Image 13-140  
Projector control, GSM configuration



Image 13-141  
SMS subscription



Image 13-142  
Subscriber

2. Select *Subscriber 1* and press **ENTER**.



Image 13-143

3. Enter the GSM number of Subscriber 1.

The GSM number must be entered with the following mask **###XXXYYYYYY**

**+** is mandatory before starting with the country code.

**##** = country code, 1, 2 or 3 digits

**XXX** = operator number length depends on the country (do not enter the 0)

**YYYYYY** = phone number

The **+** must be followed by at least 7 digits (country+operator number+phone number > 7)

4. Press **ENTER** to accept the phone number.

The software checks if the **+** is entered and that at least 7 digits are entered. When it is not a valid number, the number field next to the selected subscriber remain blank.

This procedure can be repeated for subscriber 2 and 3.

5. Select **OK** and press **ENTER** to configure the subscription.

### How to unsubscribe via the OSD menu

1. Press **Menu** to activate the menus and select *Projector Control* → *GSM configuration* → *Sms subscriptions*.

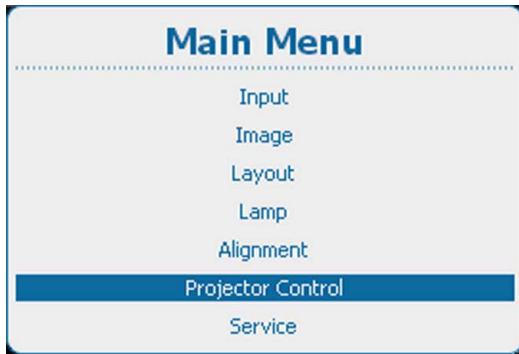


Image 13-144  
Main menu, projector control

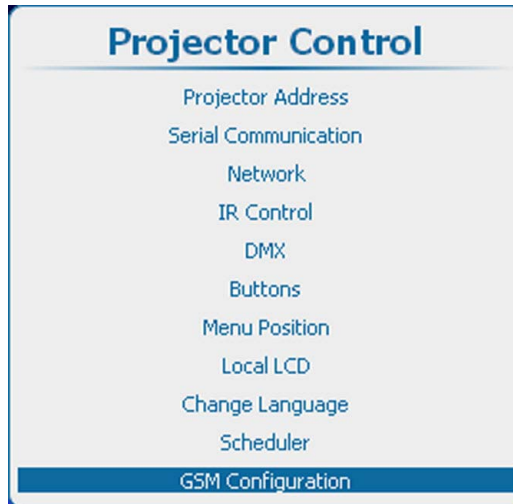


Image 13-145  
Projector control, GSM configuration



Image 13-146  
SMS subscription

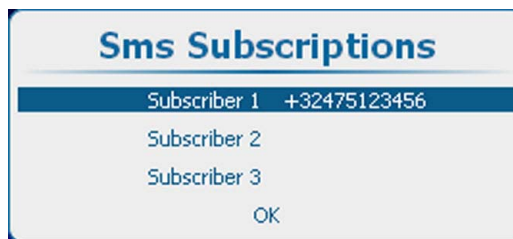


Image 13-147  
Subscriber 1

2. Press **ENTER** to open the Edit mode. Clear the current number and press **ENTER** again.
3. Select **OK** and press **ENTER** to configure the software.

### Subscribe or Unsubscribe via SMS

1. Create a new SMS message containing 2 parts:
  - activation code (created in Projector Toolset)
  - action string
 separated by a space character.

Example :

to subscribe : "1234 SUBSCRIBE"

to unsubscribe : "1234 UNSUBSCRIBE"

2. Send this message to the GSM number associated with the projector.

The receiving projector analyses the message and add or remove the GSM number associated with the message.

A result message is sent back to the requested cell phone.

## 13.15 FLEX, light output configuration

### 13.15.1 About FLEX, Light output control

#### Overview

With the FLEX technology the projector owners can lock the light output to different levels. The locking can be done via 3 different ways:

- Via Projector Toolset when connected via an Ethernet connection with the projector. See Projector Toolset's user guide (R5905073, index 04), chapter "FLEX, light output control".
- Via the OSD menu of the projector itself
- Via an SMS message send to a projector equipped with an optional GSM board.

To lock to a specific value a 4 digit code is necessary; These codes can be created by the projector owner using Projector Toolset.

### 13.15.2 Light output configuration via OSD menu

#### What can be done ?

The activation code can be entered by the projector user. This code is validated and when valid the maximum light output is set accordingly.

#### How to set

1. Press **Menu** to activate the menus and select *Projector Control*.

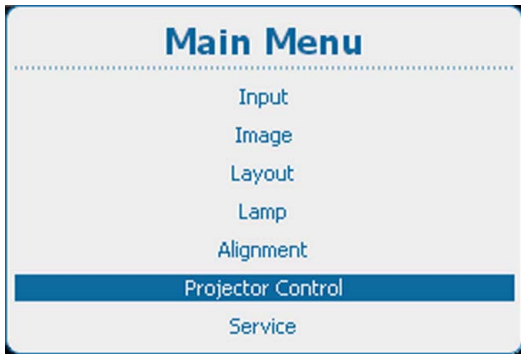


Image 13-148  
Main menu, projector control

2. While *Projector Control* is selected, enter the hidden code "8069".

A Device configuration menu opens.



Image 13-149  
Projector control, device configuration

3. Enter the 4 digits of the activation code using the digit keys on the remote control or the local keypad.  
If the code is correct, the message: "Device successful configured as <projector name>" is displayed and the projector is set to corresponding maximum light output.



Image 13-150  
Successful configured

If the code is incorrect, the message: "Invalid attempt!", is displayed:

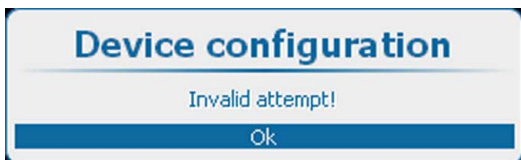


Image 13-151  
Invalid attempt

After 3 invalid attempts, the message: "Invalid attempt! Try again after 300 seconds" is displayed.

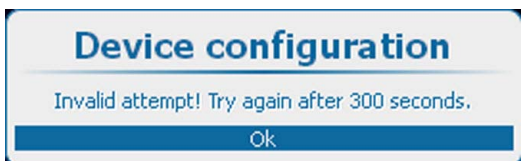


Image 13-152



### 13.15.3 Configure projector's light output via SMS



Projector must be equipped with the optional GSM module.

#### What can be done ?

An SMS message with certain structure must be sent to the SIM card of the projector. This message will be picked up and decoded. The projector will be configured according to the content of the message.

#### How to configure

1. Create a new SMS message containing 3 parts:
  - activation code (created in Projector Toolset)
  - action string
  - action parameter
 separated by a space character.  
 Example : "1234 MLO 14"
2. Send this message to the GSM number associated with the projector.
 

The receiving projector analyses the message and configures the light output.

A result message is sent back to the requested cell phone.

### 13.16 SMS services



Projector must be equipped with the optional GSM module.

#### Overview

- Request for notifications
- Request for information
- Lamp ignition admission

#### 13.16.1 Request for notifications

##### What can be done ?

Via an SMS message sent from any cell phone to the GSM number associated with the projector, notification information can be requested. The receiving projector analyses the message. The projector answers with an SMS of maximum 140 characters containing all the active notifications sorted from the highest to the lowest severity that fit in this one message.

##### How to request

1. Create a new SMS message containing 2 parts
  - activation code (created in Projector Toolset), 4 digits
  - action string NOTIF
 separated by a space character.  
 Example : "1234 NOTIF"
 

Activation code can be generated with Projector Toolset. See Projector Toolset's user guide, chapter "Communication", "Mobile settings".
2. Send this message to the GSM number associated with the projector.
 

The receiving projector analyses the message and creates a return SMS.

This message is sent back to the requested cell phone.

### 13.16.2 Request for information

#### Request for information

Via an SMS message sent from any cell phone to the GSM number associated with the projector, projector information can be requested. The receiving projector analyses the message. The projector answers with an SMS of maximum 140 characters containing the projector type, name and serial number, projector and lamp run time, lamp and projector status.

#### How to request

1. Create a new SMS message containing 2 parts
  - activation code (created in Projector Toolset), 4 digits
  - action string INFO.separated by a space character.

Example : "1234 INFO"

Activation code can be generated with Projector Toolset. See Projector Toolset's user guide, chapter "Communication", "Mobile settings".

2. Send this message to the GSM number associated with the projector.  
The receiving projector analyses the message and creates a return SMS.  
This message is sent back to the requested cell phone.

### 13.16.3 Lamp ignition admission

#### What can be done?

Via an SMS message sent from any cell phone to the GSM number associated with the projector, lamp ignition admission can be enabled or disabled. When enabled, the user can start up the projector in a normal way. When disabled, the lamp of the projector cannot start up. A failed message "**Lamp Ignition permitted**" will be displayed.

#### How to request

1. Create a new SMS message containing 3 parts
  - activation code (created in Projector Toolset), 4 digits
  - action string LAMP.
  - action argument (ENABLE or DISABLE)separated by a space character.

Example : "1234 LAMP DISABLE"

Activation code can be generated with Projector Toolset. See Projector Toolset's user guide, chapter "Communication", "Mobile settings".

2. Send this message to the GSM number associated with the projector.  
The receiving projector analyses the message and execute the command. It creates a return SMS with the following message: "**Lamp ignition enable**" or "**Lamp ignition disabled**" or "**Lamp ignition admission failed**".  
This message is sent back to the requested cell phone.

## 14. SERVICE

### Overview

- Service menu overview
- Identification
- Diagnosis
- Internal Service Patterns
- Convergence
- Factory defaults
- USB memory
- Reset Formatter
- Refill mode
- Save Custom Settings
- Special HD Camera mode
- Auto Dimming when over-temperature
- Time and Date

### 14.1 Service menu overview

#### Overview table

Level 1	Level 2	Level 3
Service	Identification	
	Diagnostics	Version Measurements Logging Board Id Notifications Tilt sensor
	Internal Service Patterns	PMP IN OSD PMP OUT FIB
	Convergence	Blue Green on Blue Red on Blue
	Factory Defaults	
	USB Memory	Save custom settings Load custom settings
	Reset Formatter	
	Refill Mode	
	Save Custom Settings	
	Special HD Camera Mode	
	Auto Dimming when Overtemperature	
	Time and Date	

## 14.2 Identification

### What can be seen?

The identification screen shows the general information about the projector.

The following items will be displayed:

- Projector type
- Projector address
- Software version
- Configuration
- Baudrate
- IP address
- MAC address
- Status of the on screen text
- Serial number
- Projector Runtime
- Lamp on runtime
- Remaining Lamp runtime
- Customer Id

### How to display the overview

1. Press **Menu** to activate the menus and select *Service* → *Identification*.

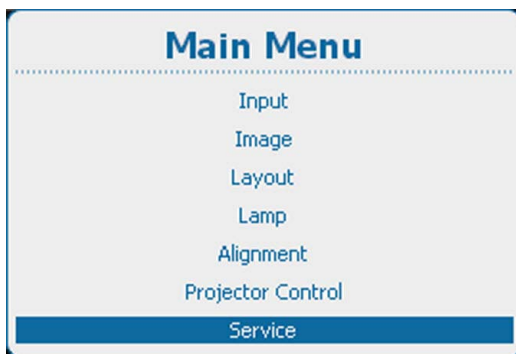


Image 14-1  
Main menu, service

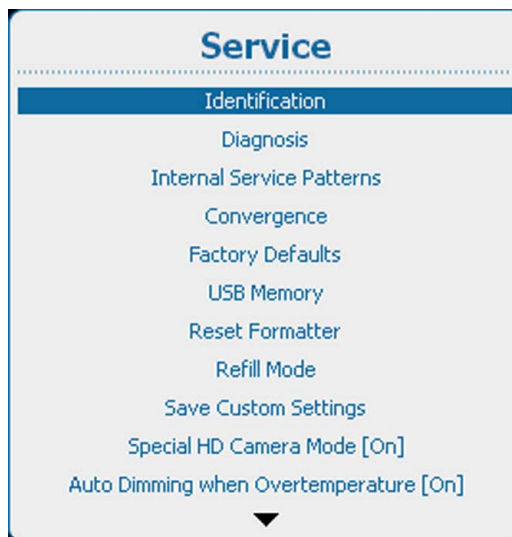


Image 14-2  
Service, identification

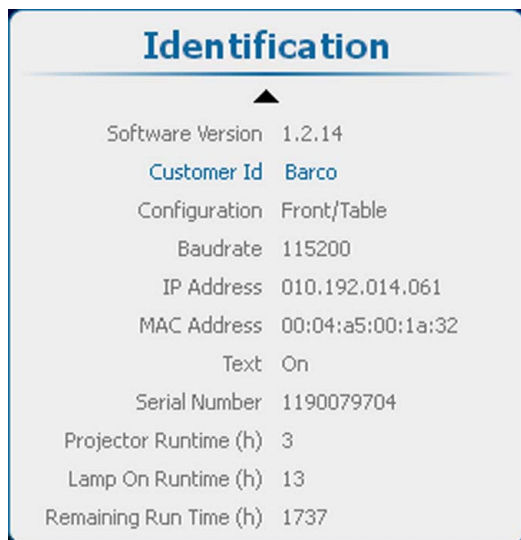


Image 14-3  
Identification

2. Use the ▲ or ▼ key to scroll through the menu.

## 14.3 Diagnosis

### What can be seen?

The diagnosis menu gives the possibility to get an overview of the working of the projector.

### Overview

- Versions
- Measurements
- Logging
- Board Id
- Notification
- Tilt sensor

#### 14.3.1 Versions

##### About versions

The table gives an overview between the reference software and the current installed software.

The reference software is the latest correctly installed package.

The current is the updated software (upgrade of downgrade).

Once the complete current is updated with new software, then this current becomes the new reference.

= means that the current software is equal to the latest reference.

> the current has a higher version than the reference software.

< the current has a lower version than the reference software.

##### How to display an overview

1. Press **Menu** to activate the menus and select *Service* → *Diagnosis* → *Versions*.

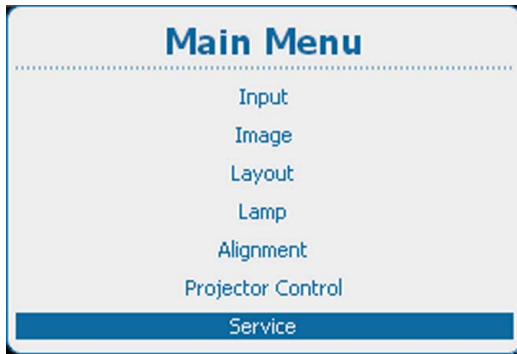


Image 14-4  
Main menu, service

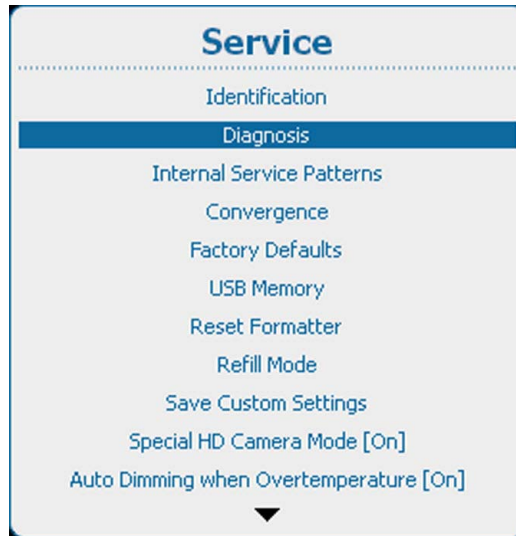


Image 14-5  
Service, diagnosis

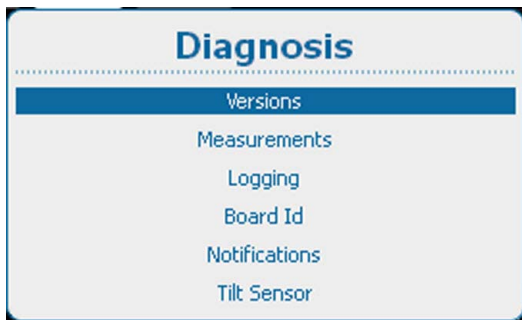


Image 14-6  
Diagnosis, versions

2. Press **ENTER** to display an overview of the versions.

	Current	< = >	Reference
Hdx update package		= >	1.0.1
<b>Main Controller Applications</b>			
Main ctrl mgr software	1.0.1	=	1.0.1
Main ctrl gui software	1.0.1	=	1.0.1
Send To Socket	1.4.1	=	1.4.1
Broadcast	3.0.1	=	3.0.1
Webserver	1.0.3	=	1.0.3
<b>Main Controller Settings</b>			
Image files	2.1.8	=	2.1.8
Layout files	1.0.3	=	1.0.3
Color standards files	1.0.1		
Guidata	1.8.1	=	1.8.1

Image 14-7  
Diagnosis, versions list

### 14.3.2 Measurements

#### About measurements

Measurements contains the following parts:

- Voltages
- Temperatures
- Fan speeds

All tables are built up in an identical way. The current measured value is surrounded with the low and high error and warning limits. Once one of these values are crossed the threshold an error or warning message is logged or displayed on the local LCD screen.

### How to display an overview

1. Press **Menu** to activate the menus and select *Service* → *Diagnosis* → *Measurements*.

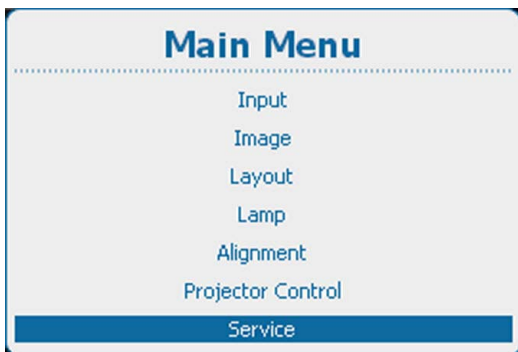


Image 14-8  
Main menu, service

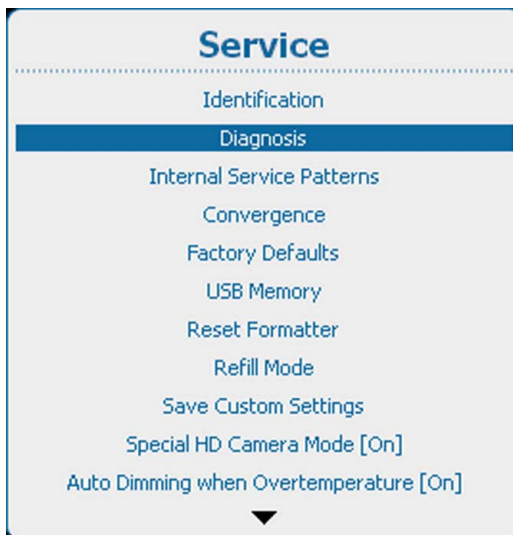


Image 14-9  
Service, diagnosis

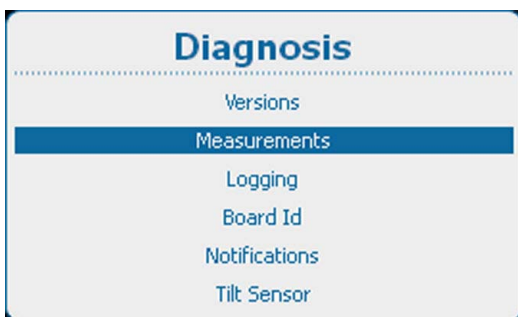


Image 14-10  
Diagnosis, measurements

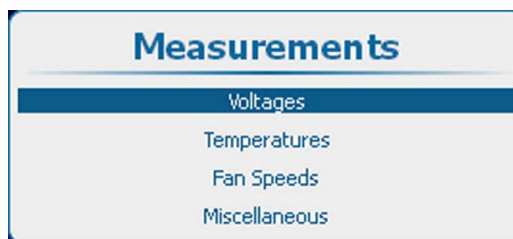


Image 14-11  
Measurements, voltages

2. Use the ▲ or ▼ key to select *Voltages* and get an overview of the voltages or to select *Temperatures* to get an overview of the internal temperatures or to select *Fan Speeds* to get an overview of current speeds of the different fans or to get an overview of miscellaneous items such as pressure altitude etc.

	Low Error	Low Warning	Current	High Warning	High Error
pump	10V	10.5V	12.2V	13.5V	14V
12V	11V	11.5V	12.4V	13V	13.5V
28V	25V	26V	28.9V	30V	31V
14V	4V	4.5V	13.9V	15.5V	16V
2.5V	2.3V	2.3V	2.4V	2.7V	2.7V
mains	85V	90V	225V	270V	275V

Image 14-12  
Overview voltages

	Low Error	Low Warning	Current	High Warning	High Error
dmd red back	-15°C	0°C	31.3°C	55°C	65°C
dmd red block	-15°C	NA	40.1°C	70°C	74.5°C
dmd green back	-15°C	0°C	31.2°C	55°C	65°C
dmd green block	-15°C	NA	40.8°C	70°C	74.5°C
dmd blue back	-15°C	0°C	31.2°C	55°C	65°C
dmd blue block	-15°C	NA	41.1°C	70°C	74.5°C
ambient outside	-15°C	-5°C	31.2°C	38°C	55°C
engine air	-15°C	-5°C	36.4°C	70°C	75°C
rod in	-15°C	NA	43.4°C	90°C	100°C
air out	-15°C	NA	46.7°C	90°C	100°C
power supply secondary	-15°C	NA	39.3°C	90°C	100°C
power supply primary dc/dc	-15°C	NA	36.1°C	90°C	100°C

Image 14-13  
Overview temperatures

	Low Error	Low Warning	Current	High Warning	High Error
pump	3000rpm	3200rpm	4536rpm	9000rpm	10000rpm
cold mirror	500rpm	700rpm	3090rpm	9000rpm	10000rpm
engine	500rpm	700rpm	3466rpm	9000rpm	10000rpm
radiator A	500rpm	700rpm	1859rpm	9000rpm	10000rpm
radiator B	500rpm	700rpm	1845rpm	9000rpm	10000rpm
powerbox	500rpm	700rpm	2264rpm	9000rpm	10000rpm
lamp	500rpm	700rpm	2059rpm	9000rpm	10000rpm

Image 14-14  
Overview fan speeds

	Low Error	Low Warning	Current	High Warning	High Error
pressure altitude	NA	NA	-46m	NA	NA

Image 14-15  
Overview miscellaneous items

### 14.3.3 Logging

#### What can be done?

Projector hosts two log files: one managed by the Main controller and one specific for the Lamp power supply.

#### How to display the logging

1. Press **Menu** to activate the menus and select *Service* → *Diagnosis* → *Logging*.



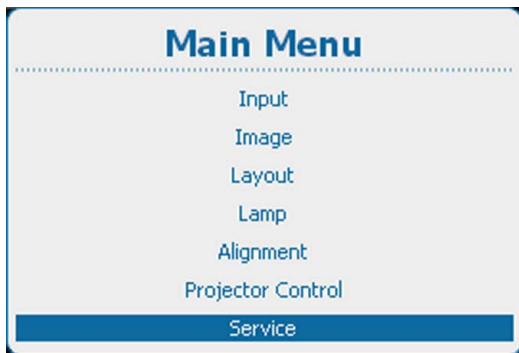


Image 14-16  
Main menu, service

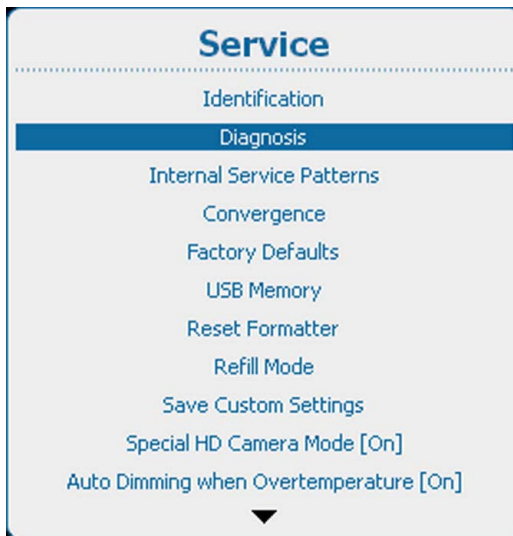


Image 14-17  
Service, diagnosis

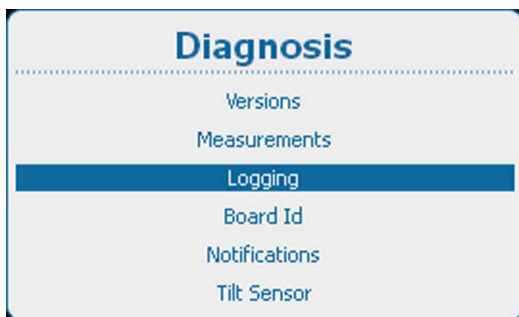


Image 14-18  
Diagnosis, logging



Image 14-19  
Logging, main controller

- Use the ▲ or ▼ key to select *Main Controller* to get a logging of the main controller or to select *Lamp Power Supply* to get a logging of the lamp power supply.

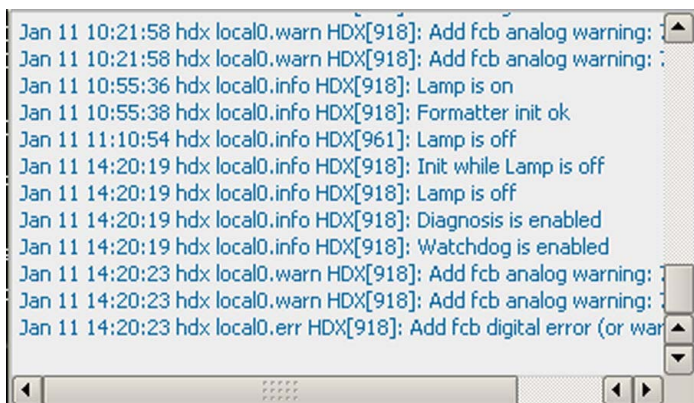


Image 14-20  
Main controller logging

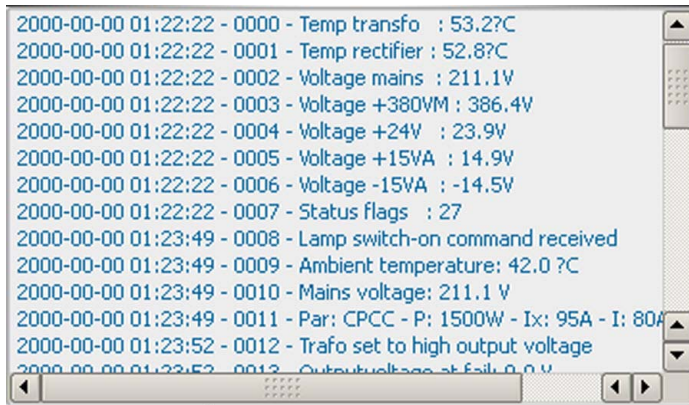


Image 14-21  
Lamp power supply logging

### 14.3.4 Board Id

#### About Board Id

The board id window gives an overview of the modules with their article number, serial number, etc.

#### How to get an overview

1. Press **Menu** to activate the menus and select *Service* → *Diagnosis* → *Board Id*.

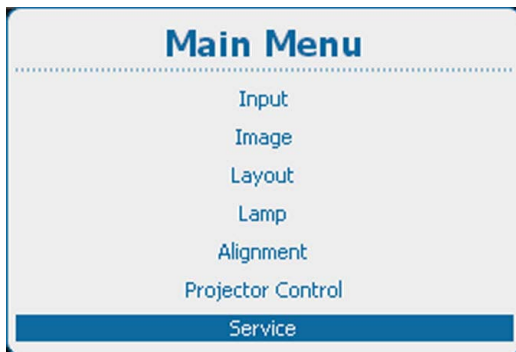


Image 14-22  
Main menu, service

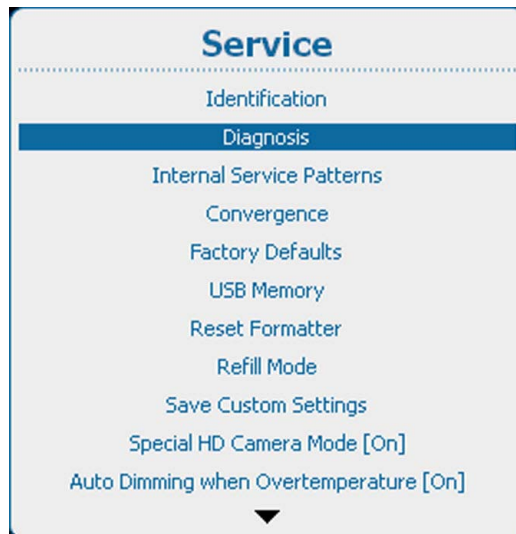


Image 14-23  
Service, diagnosis

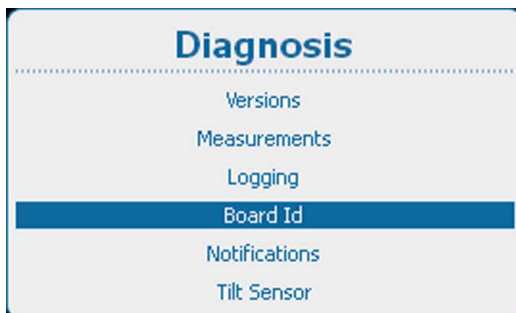


Image 14-24  
Diagnosis, board ID

2. Press **ENTER** to display an overview of the board IDs.



Image 14-25  
Overview board IDs

### 14.3.5 Notification

#### About notifications

Notifications are warnings and errors displayed on the local LCD or on the OSD since power on of the projector. Once powered off, the notification logging is cleared.

#### How to display

1. Press **Menu** to activate the menus and select *Service* → *Diagnosis* → *Notifications*.

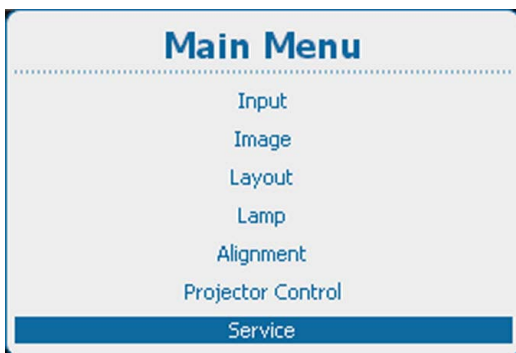


Image 14-26  
Main menu, service

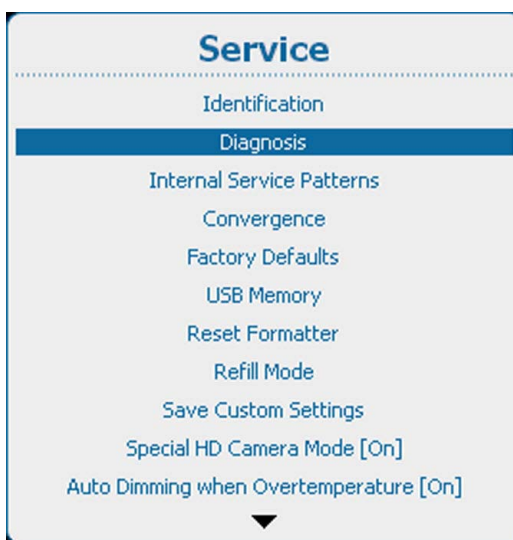


Image 14-27  
Service, diagnosis

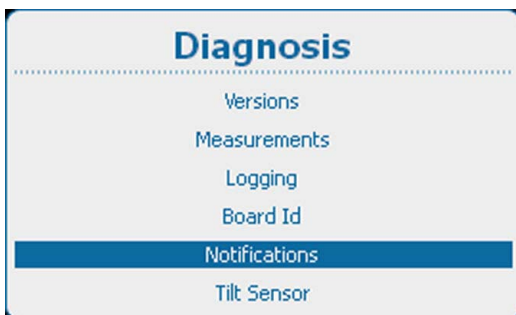


Image 14-28  
Diagnosis, notifications

2. Press **ENTER** to display the notification list.

Time Stamp	Severity	Count	Description
Tue Jun 4 17:08:13 2013	Info	1	Storage: successful restoring
Tue Jun 4 17:08:21 2013	Info	1	Board id: input 4 empty
Tue Jun 4 17:08:40 2013	Warning	1	Airflow switch open

Image 14-29  
Notification overview list

### 14.3.6 Tilt sensor

#### What is possible?

The built-in tilt sensor can be read out to see if the projector is used in an allowed position. The status field indicates whether the rotation of the projector is normal or abnormal.

Using a projector with an abnormal rotation can severely damage the lamp.

#### How to check the tilt sensor

1. Press **Menu** to activate the menus and select *Service* → *Diagnosis* → *Tilt sensor*.

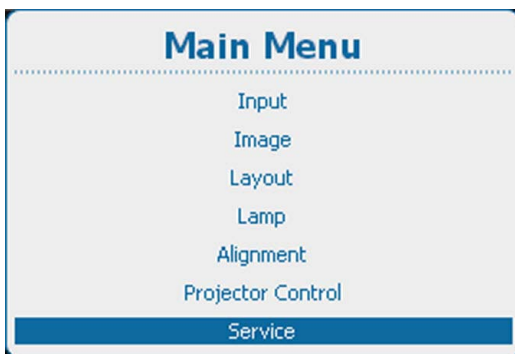


Image 14-30  
Main menu, service

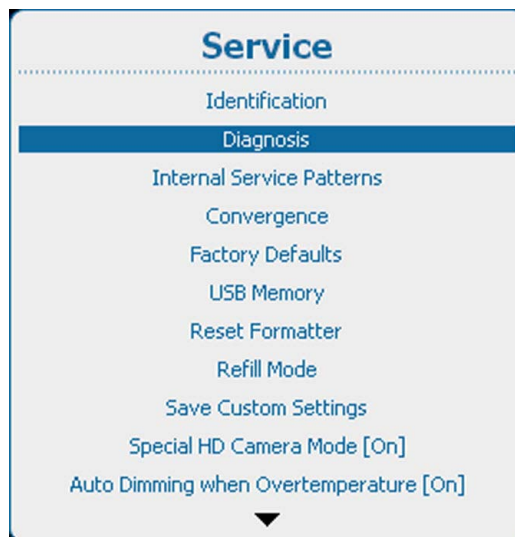


Image 14-31  
Service, diagnosis



Image 14-32  
Diagnosis, tilt sensor

2. Press **ENTER** to read out the tilt sensor.

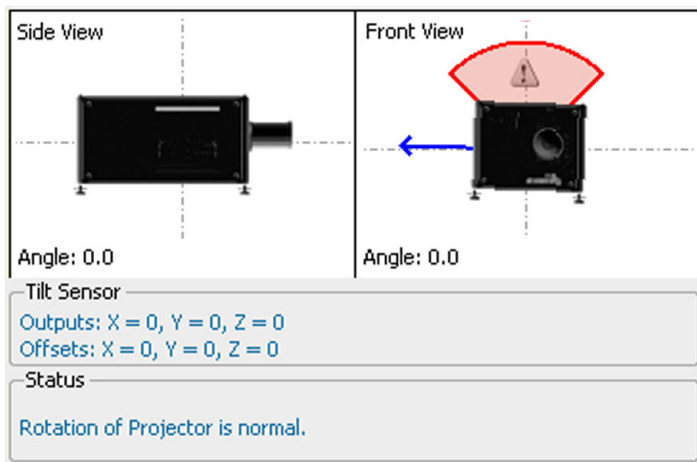


Image 14-33  
Tilt sensor output

The rotation of the projector is visually displayed. Coordinates of the tilt sensor and the offset from the normal position are given in the tilt sensor pane.

The status pane indicates if the projector is used with an allowed rotation.

## 14.4 Internal Service Patterns

### How to select

1. Press **Menu** to activate the menus and select *Service* → *Internal Service Patterns*.

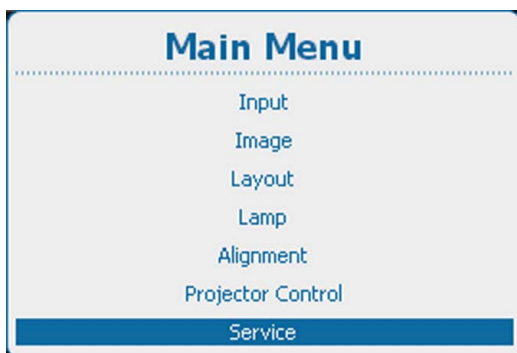


Image 14-34  
Main menu, service

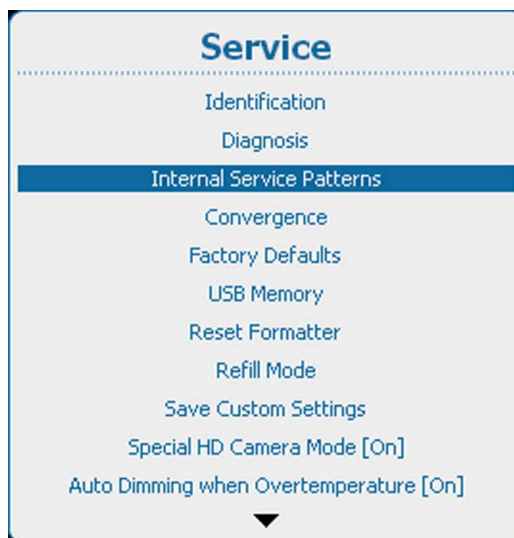


Image 14-35  
Service, Internal service patterns

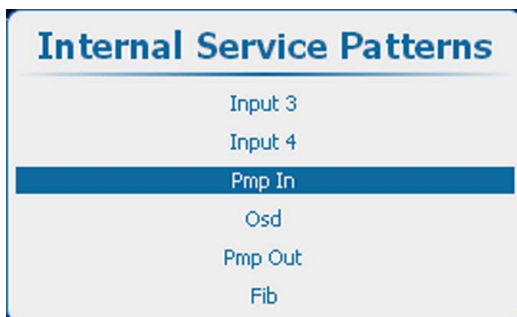


Image 14-36  
Internal service patterns, Pmp In

2. Use the ▲ or ▼ key to select the desired internal service pattern and press **ENTER** to open a selection menu.

**Input patterns**

Input items in the Internal Service Patterns menu are only shown when the corresponding slot contains an input board.

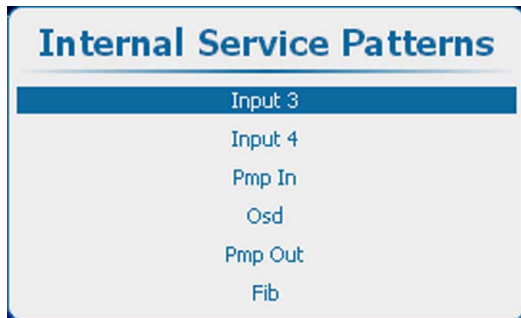


Image 14-37  
Internal service patterns, input

Press **ENTER** to display the list of possible patterns.

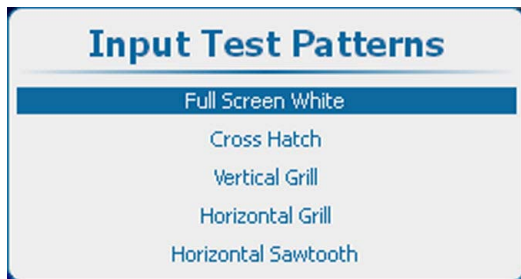


Image 14-38  
Input test patterns

**Pmp In patterns**

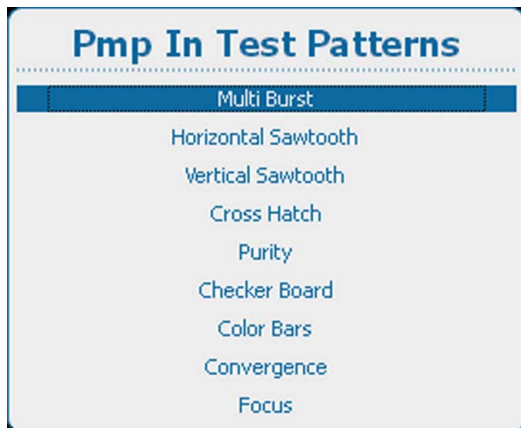


Image 14-39  
Pmp In test patterns

To change the options for the selected pattern, use the ► key to open these options. The number of options can change for the different patterns.



Image 14-40  
Pmp In test pattern options

Use the ▲ or ▼ key to select an option and press **ENTER** to select. The checkbox in front of that item will be checked.

## Osd patterns

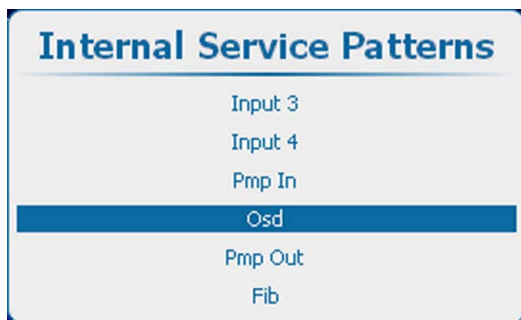


Image 14-41  
Internal service patterns, OSD

Press **ENTER** to display the list of possible patterns.

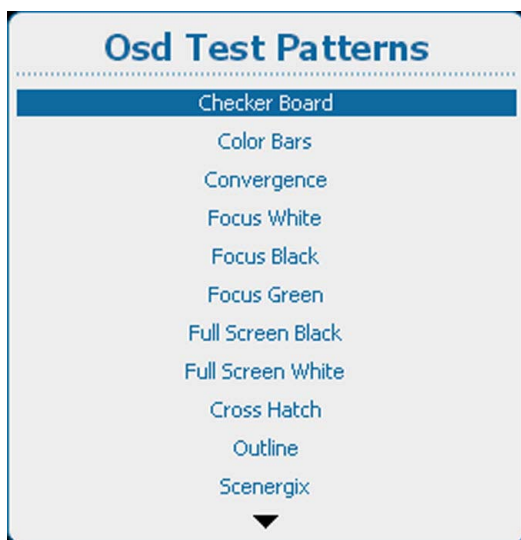


Image 14-42  
OSD Test patterns

## Pmp out patterns

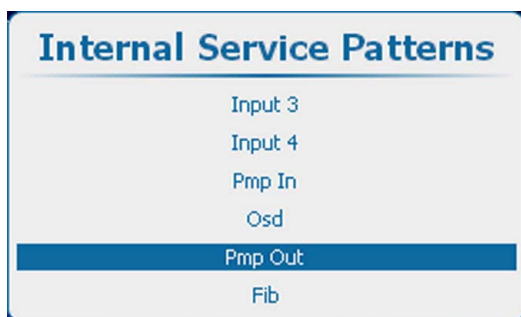


Image 14-43  
Internal service patterns, Pmp Out

Press **ENTER** to display the list of possible patterns.

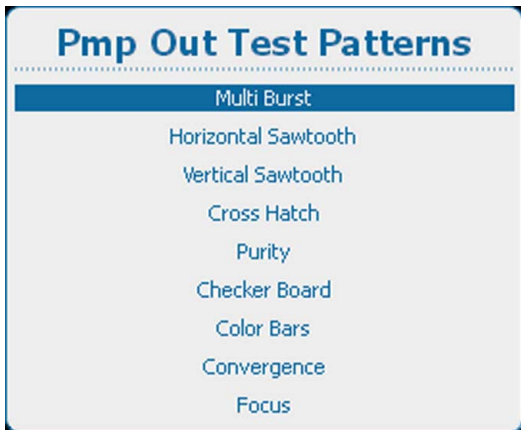


Image 14-44  
Pmp out test patterns

To change the options for the selected pattern, use the **▶** key to open these options. The number of options can change for the different patterns.

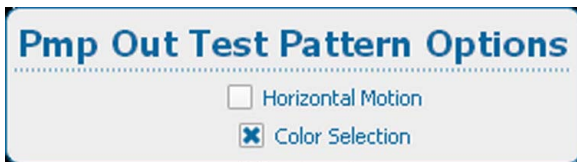


Image 14-45  
Pmp out internal service test patterns options

### Fib patterns

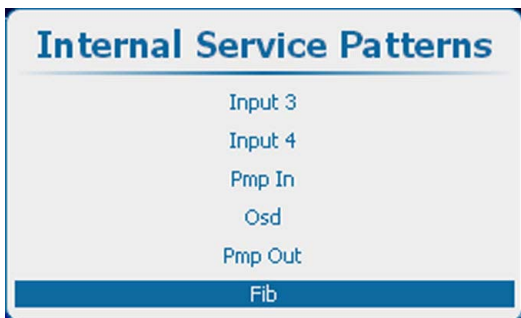


Image 14-46  
Internal service patterns, Fib

Press **ENTER** to display the list of possible patterns.

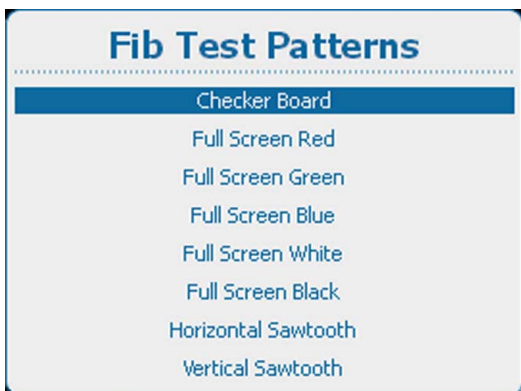


Image 14-47  
Fib test patterns



## 14.5 Convergence

### What can be done?

The convergence patterns can be used to check the convergence alignment of red, green and blue. If there is a misalignment of at least one 1 pixel, an electronic realignment is possible.

Mechanical realignment of the convergence can only be done by a qualified service technician.

### How to display the convergence settings

1. Press **Menu** to activate the menus and select *Service* → *Convergence*.

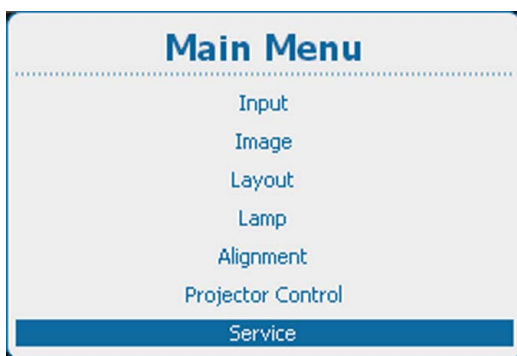


Image 14-48  
Main menu, service

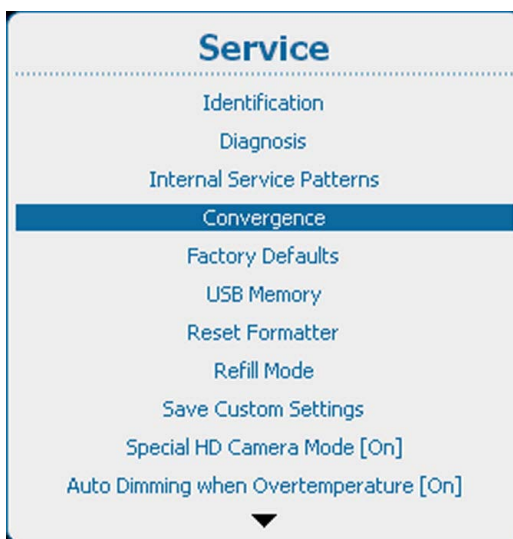


Image 14-49  
Service, convergence



Image 14-50  
Convergence pattern

2. Use the ▲ or ▼ key to select a pattern.
3. Press **ENTER** to start the adjustment.



Image 14-51  
Convergence adjustment

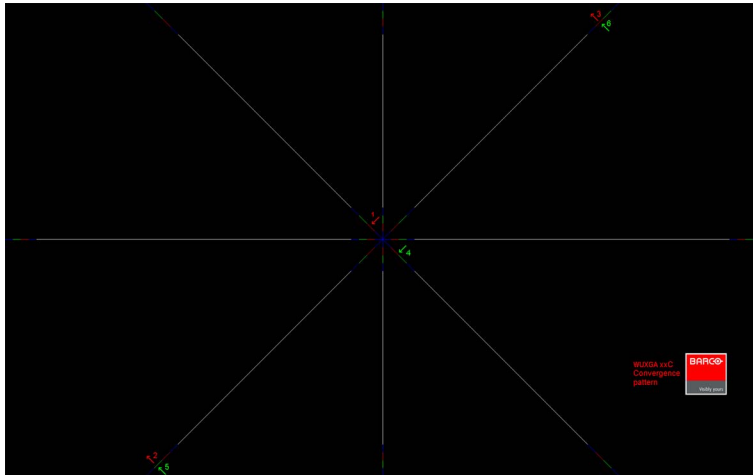


Image 14-52

4. Use the ▲ or ▼ key to adjust vertical and the ◀ or ▶ key to adjust vertical convergence.

Adjust until the crossing of the center Green (Red) convergence pattern coincide with the diagonal line of the center Blue convergence pattern.

## 14.6 Factory defaults

### What can be done?

All settings of the projector will be set to the original factory settings. All user settings are erased with this operation.

### How to return to the factory defaults

1. Press **Menu** to activate the menus and select *Service* → *Factory defaults*.

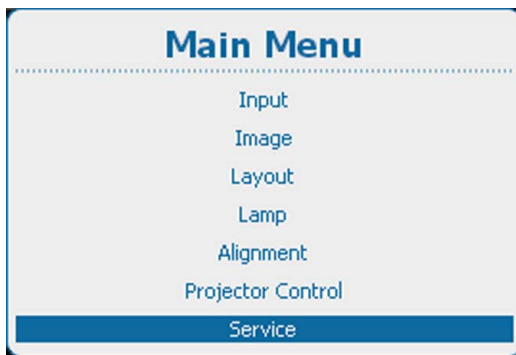


Image 14-53  
Main menu, service

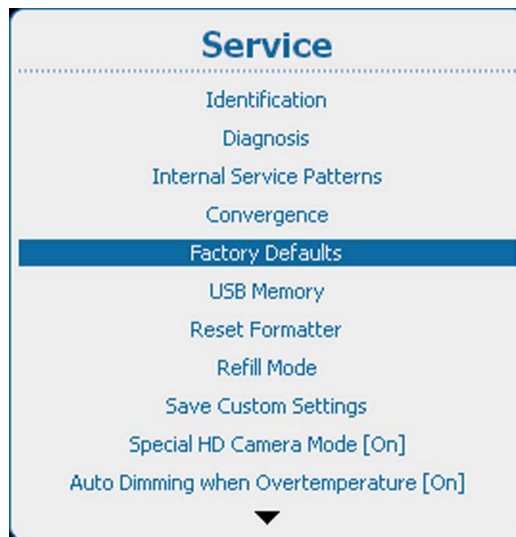


Image 14-54  
Service, factory defaults

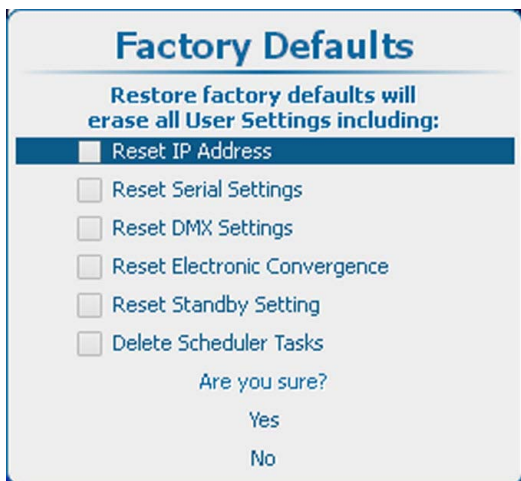


Image 14-55  
Factory defaults, settings

By default the following settings are excluded

- IP address
- Serial settings
- DMX settings
- Electronic convergence
- Standby settings
- Scheduler tasks

2. If you want to restore also one of the items in the list, check the check box in front of that item. Select *Yes* to restore the factory settings. Select *No* to stop the restore process.

## 14.7 USB memory

### Purpose

2 functions are available

- Custom settings can be saved on a USB stick.
- A selection of saved settings can be (down)loaded via an USB stick on the projector.

### How to save custom settings

1. Press **Menu** to activate the menus and select *Service* → *USB Memory*.

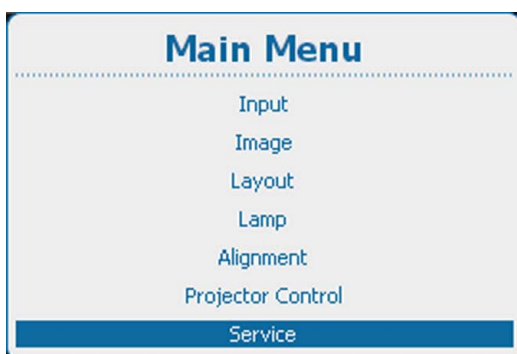


Image 14-56  
Main menu, service

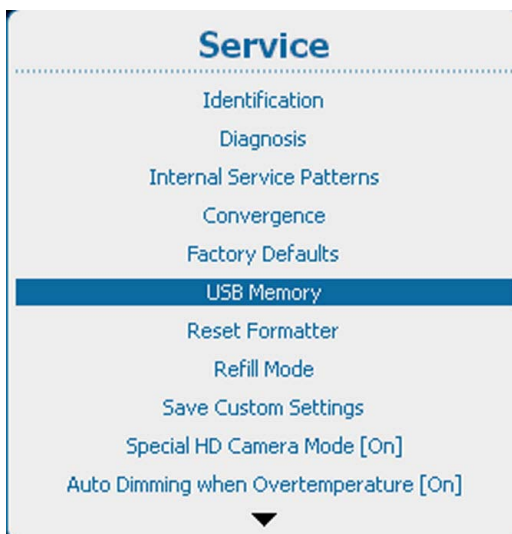


Image 14-57  
Service, USB memory



Image 14-58  
USB memory selection

2. Select *Save Custom Settings* and press **ENTER** to download this set.

**Note:** Make sure a formatted USB stick is inserted in the USB connector.

*When no USB stick is available, a message will be shown: No USB device is found.*

The name of the custom settings files contains the serial number of the projector from which it is downloaded.

### Load custom settings

1. Press **Menu** to activate the menus and select *Service* → *USB Memory*.

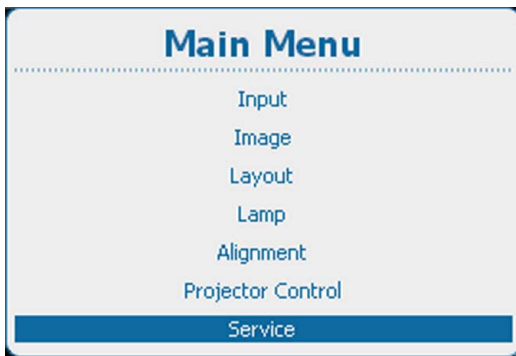


Image 14-59  
Main menu, service

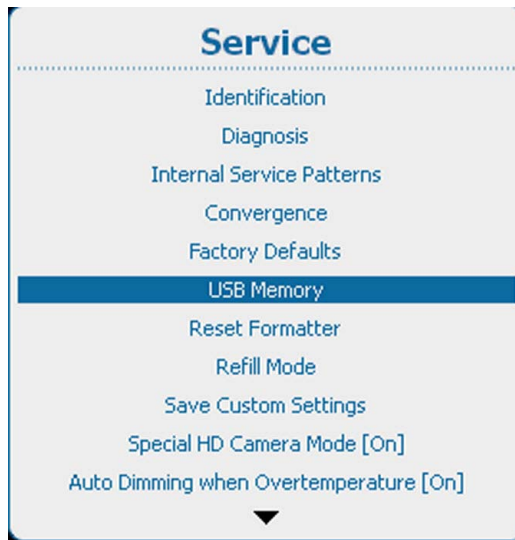


Image 14-60  
Service, USB memory



Image 14-61  
USB memory selection

2. Select *Load Custom Settings* and press **ENTER**.

An overview of the available sets of custom settings is given.

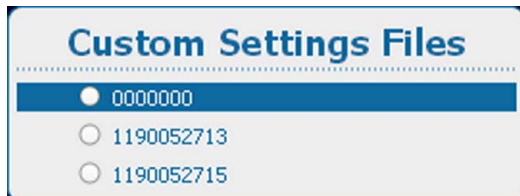


Image 14-62  
Custom settings files

3. Select a set and press **ENTER** to upload this set.

## 14.8 Reset Formatter

### Why and when

A reset formatter is necessary when e.g. a color is missing, artifacts are visible in the image or image is frozen and the formatter test patterns cannot be displayed.

### How to reset

1. Press **Menu** to activate the menus and select *Service* → *Reset Formatter*.

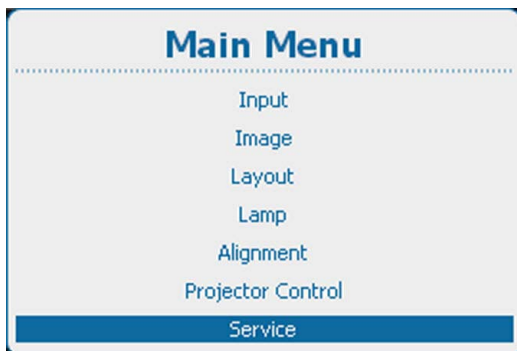


Image 14-63  
Main menu, service

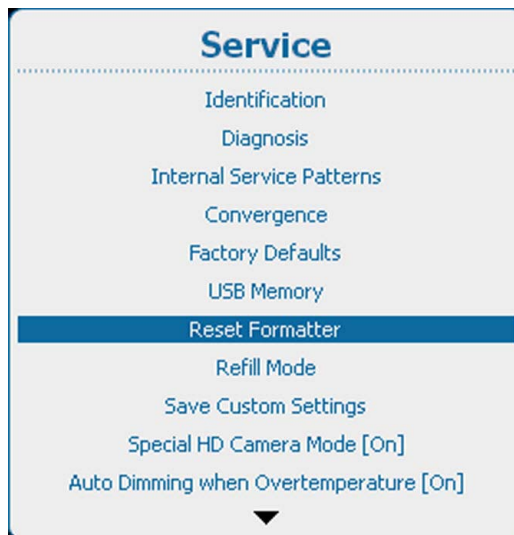


Image 14-64  
Service, reset formatter.

2. Press **ENTER** to select. Use the **▲** or **▼** key to select *Yes*. or *No* and press **ENTER**.



Image 14-65  
Reset formatter

If you want to reset the formatter, select *Yes*.

If you do not want to reset the formatter, select *No*.

## 14.9 Refill mode



**Before selecting Refill mode, take first all preparations necessary to refill the cooling circuit.**

### What can be done?

When all necessary preparations are taken, the refill mode activates automatically the refill process.

For more information about the refill process, consult the Service manual.

### How to start the refill mode

1. Press **Menu** to activate the menus and select *Service* → *Refill Mode*.

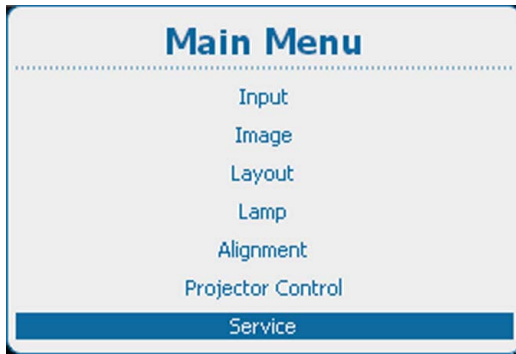


Image 14-66  
Main menu, service

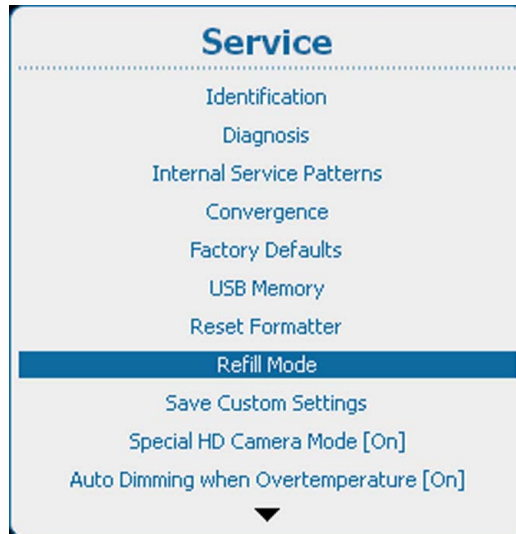


Image 14-67  
Service, refill mode

2. Press **ENTER** to select. Use the **▲** or **▼** key to select **Yes.** or **No** and press **ENTER**.

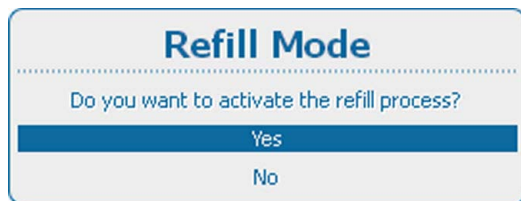


Image 14-68

If you want to start the refill mode, select **Yes**.  
If you do not want to start the refill mode, select **No**.

## 14.10 Save Custom Settings

---

### What can be done ?

The current custom settings can be saved to internal backup device in the same way as it would be done when the projector lamp was switched off.

When settings are changed when the lamp is off, a manual Save custom settings must be executed to save the changes.

When the message *Saving data* is displayed, never switch off the projector.

### How to save

1. Press **Menu** to activate the menus and select *Service* → *Save Custom Settings*.

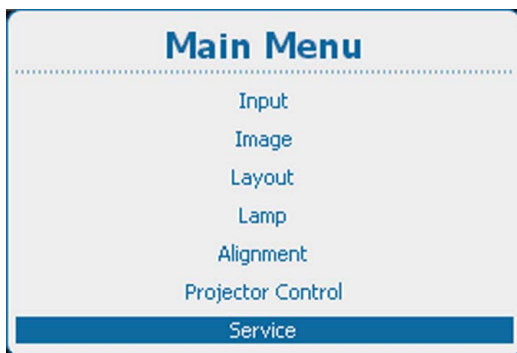


Image 14-69  
Main menu, service

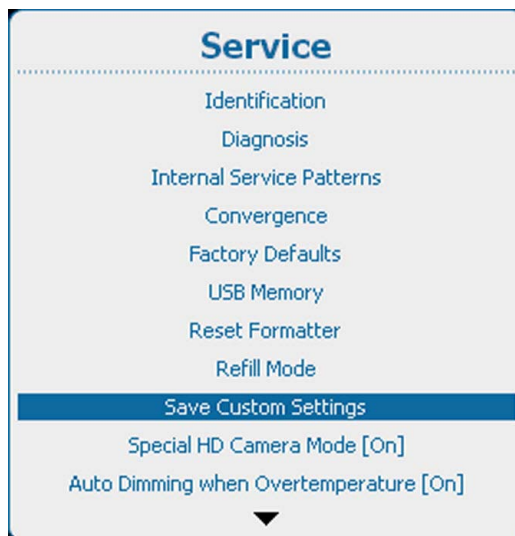


Image 14-70  
Service, save custom settings

2. Use the ▲ or ▼ key to select Yes and press **ENTER**.



Image 14-71  
Save custom settings, question

## 14.11 Special HD Camera mode

### What can be done ?

"Special HD Camera mode" enables special sequences for the DMD's to support specific sources such as the Thompson Grass Valley Worldcam. It shouldn't be used in any other circumstances as it would cause image flicker and dimmed images with normal sources.

Default position : [Off]

### How to switch

1. Press **Menu** to activate the menus and select *Service* → *Special HD Camera Mode*.

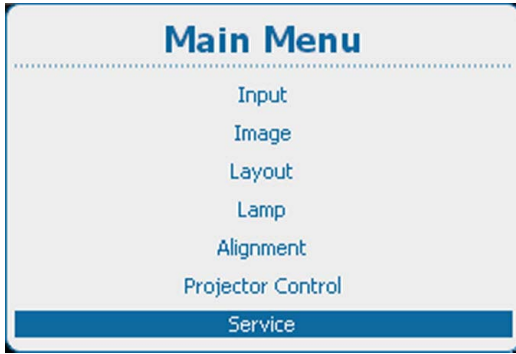


Image 14-72  
Main menu, service

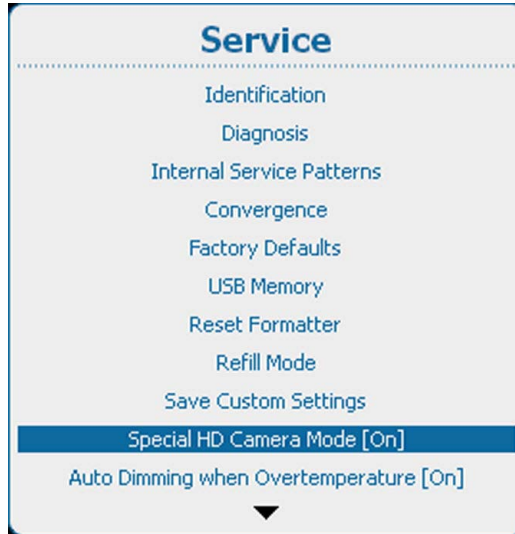


Image 14-73  
Service, special HD camera mode

2. Press **ENTER** to toggle between *[On]* and *[Off]*.

## 14.12 Auto Dimming when over-temperature

### What can happen?

When an over-temperature is detected, the projector starts dimming the lamp so that the projector can cool down.

### How to activate - deactivate

1. Press **Menu** to activate the menus and select *Service* → *Auto Dimming when Overtemperature*.

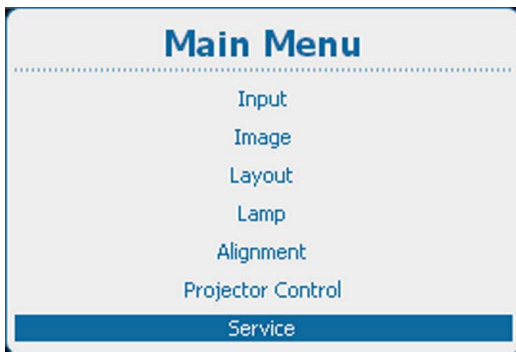


Image 14-74  
Main menu, service

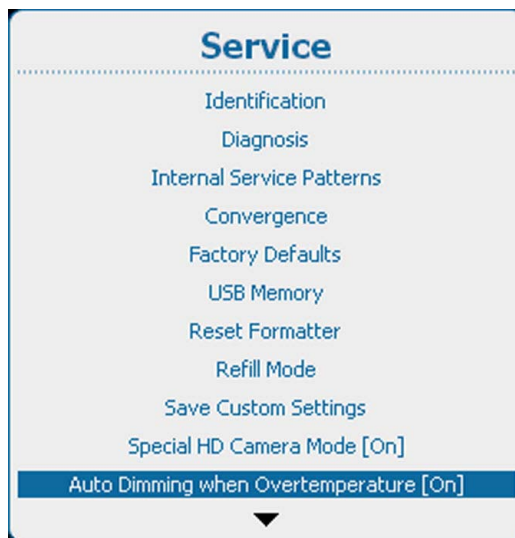


Image 14-75  
Service, auto dimming when over-temperature

2. Press **ENTER** to toggle between *[On]* and *[Off]*.  
[On] : Dimming is started when an over-temperature is detected.  
[Off] : No dimming is started when over-temperature is detected.



## 14.13 Time and Date

### How to set

1. Press **Menu** to activate the menus and select *Service* → *Time and Date*.

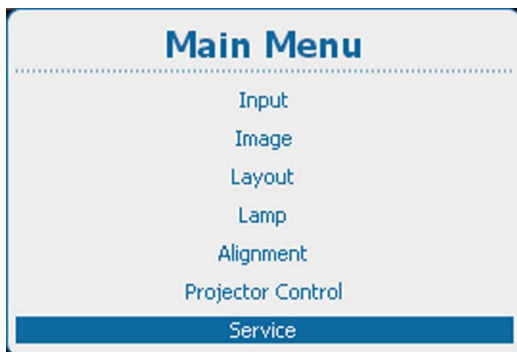


Image 14-76  
Main menu, service

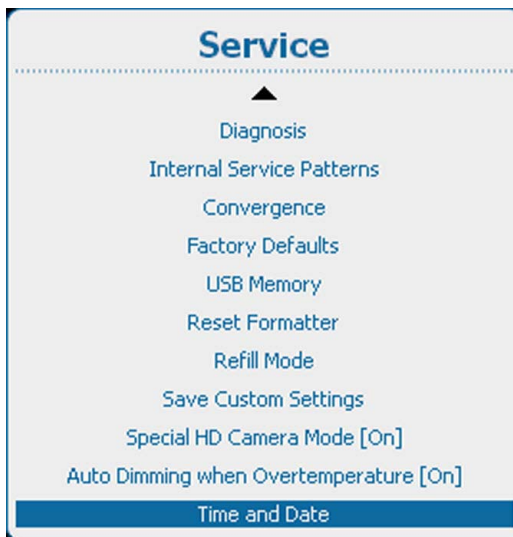


Image 14-77  
Service, time and date



Image 14-78  
Date and time set up

2. Use the ▲ or ▼ key to select *Hour*, *Minute*, *Day*, *Month* or *Year* and press **ENTER** to select.
3. Use the ▲ or ▼ key to change the selected character.  
Use the ◀ or ▶ key to select another character.  
**Note:** *Digits can be entered with the digit keys on the remote control or the local keypad. When a digit is entered in that way, the next character will be selected automatically.*
4. Press **ENTER** to accept the changes.  
Repeat for other values in the same way.



---

# 15. MAINTENANCE

## About this chapter

This chapter contains detailed maintenance procedures like dust filter replacement, lens cleaning etc. These procedures can easily be performed by the operator of the projector.

---

## 15.1 Cleaning the lens



To minimize the possibility of damage to optical coatings, or scratches to lens surfaces follow the cleaning procedure as described here precisely.

### Necessary tools

- Compressed air.
- Clean Toraysee® cloth or any micro fiber lens cleaning cloth.
- Clean cotton cloth.

### Necessary parts

Lens cleaner (e.g. Carl Zeiss lens cleaner or Purasol® or any water-based lens cleaner)

### How to clean the lens?

1. Blow off dust with clean compressed air (or pressurized air cans<sup>5</sup>).
2. Clean with lens cleaner together with a clean lens cleaning cloth to remove the dust and contamination. Use big wipes in one single direction.  
**Warning:** Do not wipe back and forwards across the lens surface as this tends to grind dirt into the coating.
3. Use a dry lens cleaning cloth to remove left liquid or stripes. Polish with small circles.
4. If there are still fingerprints on the surface, wipe them off with lens cleaner together with a clean lens cleaning cloth. Polish again with a dry one.



If smears occur when cleaning lenses, replace the cloth. Smears are the first indication of a dirty cloth.

---

## 15.2 Cleaning the exterior of the projector

### How to clean the exterior of the projector ?

1. Switch off the projector and unplug the projector from the mains power net.
2. Clean the housing of the projector with a damp cloth. Stubborn stains may be removed with a cloth lightly dampened with a mild detergent solution.

---

<sup>5</sup> Pressurized air cans are not efficient if there is too much dust on the surface, the pressure is too low



# 16. REMOVAL AND INSTALLATION OF THE PROJECTOR COVERS

## About this chapter

Most maintenance and servicing procedures demand removing one or more of the projector covers to gain access to the parts to maintain or to service. To avoid redundancy, all procedures about cover removing or installing are grouped together in this chapter. The maintenance and servicing procedures also refer to this chapter if required. The procedures in this chapter describe, with detailed step by step actions and illustrations, how to remove or install the projector covers. Note that some covers may only be removed by qualified service personnel, see remarks above each procedure.



**WARNING:** Always switch off the projector and unplug the power cord at the projector side before removing one of the covers.

## 16.1 Removal of the front cover



**WARNING:** This procedure may only be performed by qualified technical service personnel.

### Necessary tools

7 mm flat screw driver.

### How to remove the front cover

1. Remove the lens. See "*Lens removal*".
2. Remove the rubber dust ring from the lens holder.
3. Release the captive screw at the middle bottom of the front cover, using a flat screw driver.

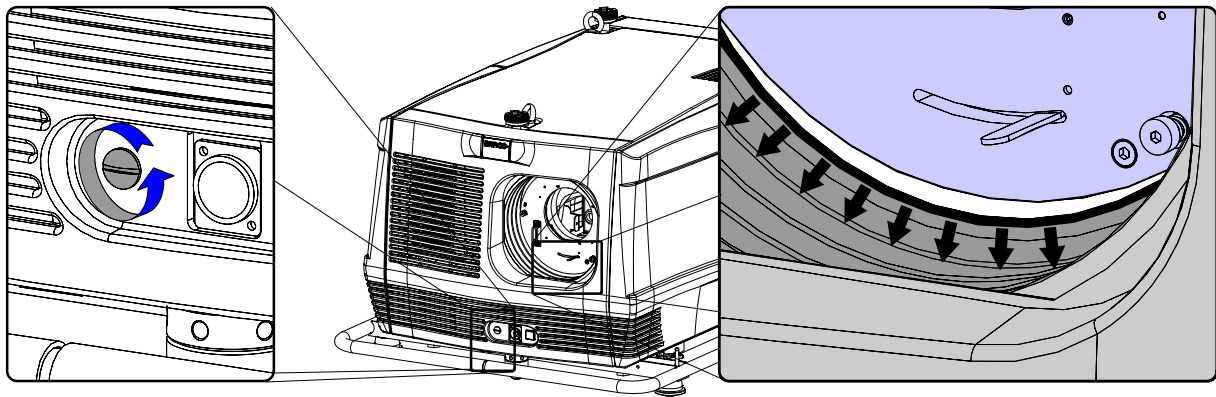


Image 16-1  
Captive screw

4. Remove the front cover from the projector as follows:
  - a) standing in front of the projector, pull the right side of the front cover toward you until the latches release (left side is hinged)
  - b) then slide the front cover to the right to release it from the hinging points.

## 16. Removal and installation of the projector covers

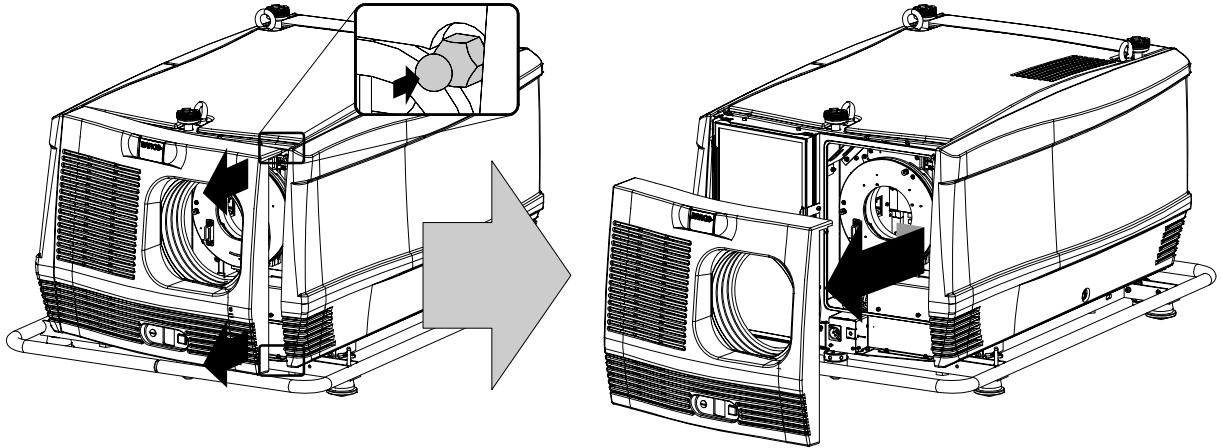


Image 16-2

### 16.2 Removal of the side cover



**CAUTION:** Remove the side cover of the projector only in a clean and dust free area. Never remove the side cover in an area which is subject to airborne contaminants such as that produced by smoke machines or similar.

#### Necessary tools

7 mm flat screw driver.

#### How to remove the side cover

1. Release the captive screw at the middle bottom of the side cover, using a flat screw driver.

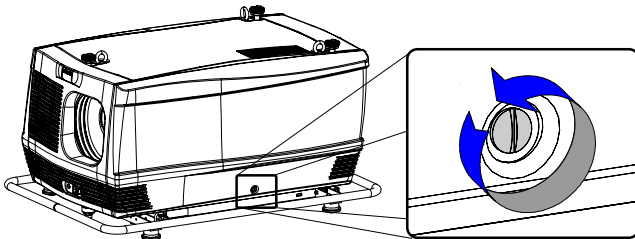


Image 16-3  
Captive screw

2. Remove the side cover from the projector as follows:
  - a) gently pull out the bottom corners (A) of the side cover,
  - b) then gently pull out the top corners (B) of the side cover,
  - c) then move the side cover away from the projector (C).

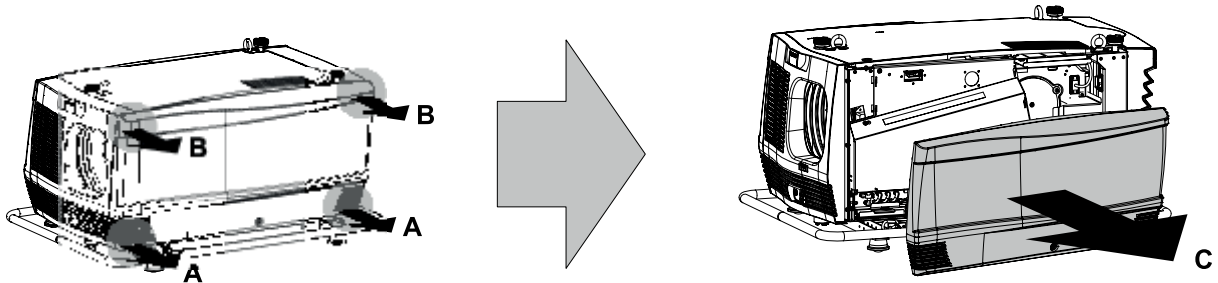


Image 16-4  
Cover removal

### 16.3 Removal of the lamp cover



**WARNING:** This procedure may only be performed by qualified technical service personnel.

#### Necessary tools

7 mm flat screw driver.

#### How to remove the lamp cover

1. Release the two captive screws at the top and bottom right side of the lamp cover, using a flat screw driver.

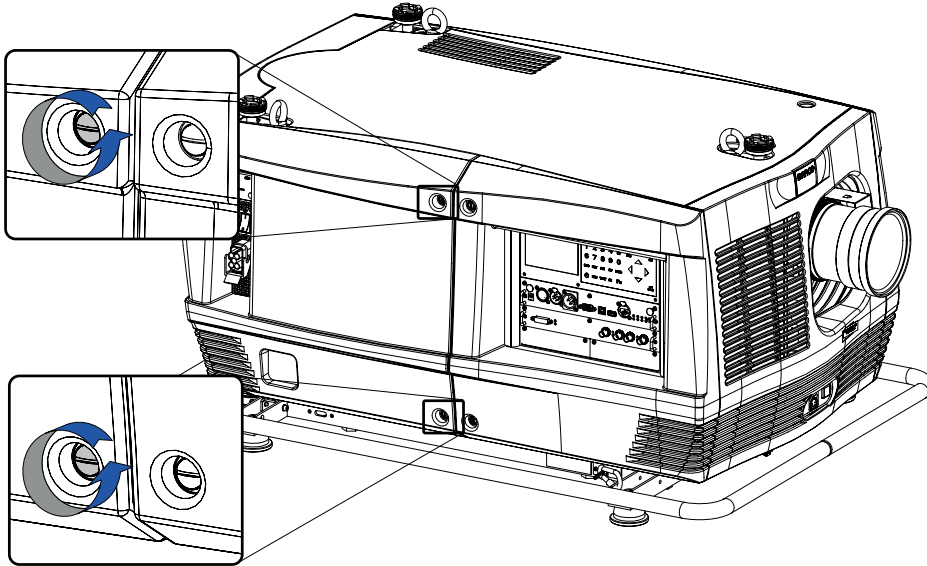


Image 16-5  
Captive screws, unlocking

2. Remove the lamp cover from the projector as follows:
  - a) gently pull out the left bottom corner (A) of the lamp cover,
  - b) then gently pull out the left top corner (B) of the lamp cover,
  - c) then move the lamp cover away from the projector (C).

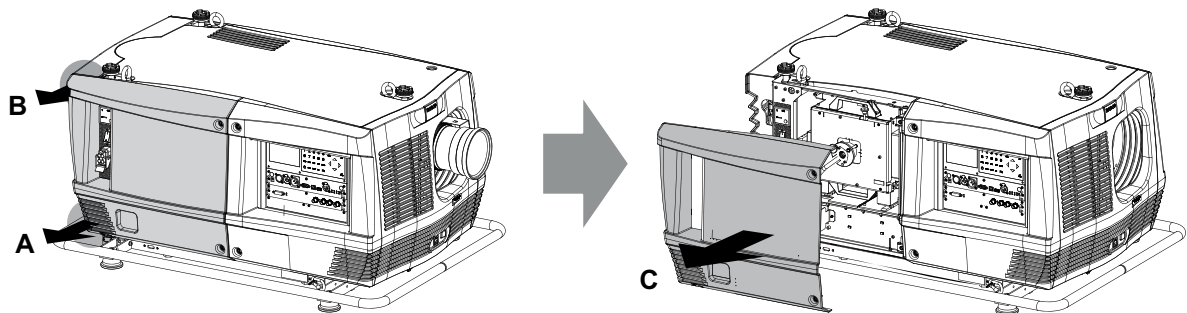


Image 16-6  
Lamp cover removal

### 16.4 Removal of the input cover



**WARNING:** This procedure may only be performed by qualified technical service personnel.

#### Necessary tools

7 mm flat screw driver.

## 16. Removal and installation of the projector covers

### How to remove the input cover

1. Release the two captive screws at the top and bottom left side of the input cover, using a flat screw driver.

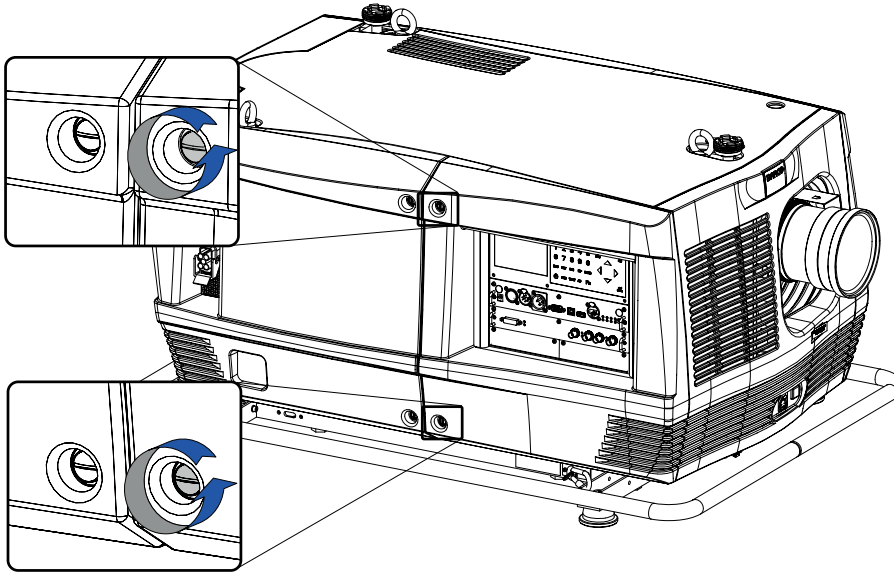


Image 16-7  
Captive screws input cover

2. Remove the input cover from the projector as follows:
  - a) gently pull out the right bottom corner (A) of the input cover,
  - b) then gently pull out the right top corner (B) of the input cover,
  - c) then move the input cover away from the projector (C).

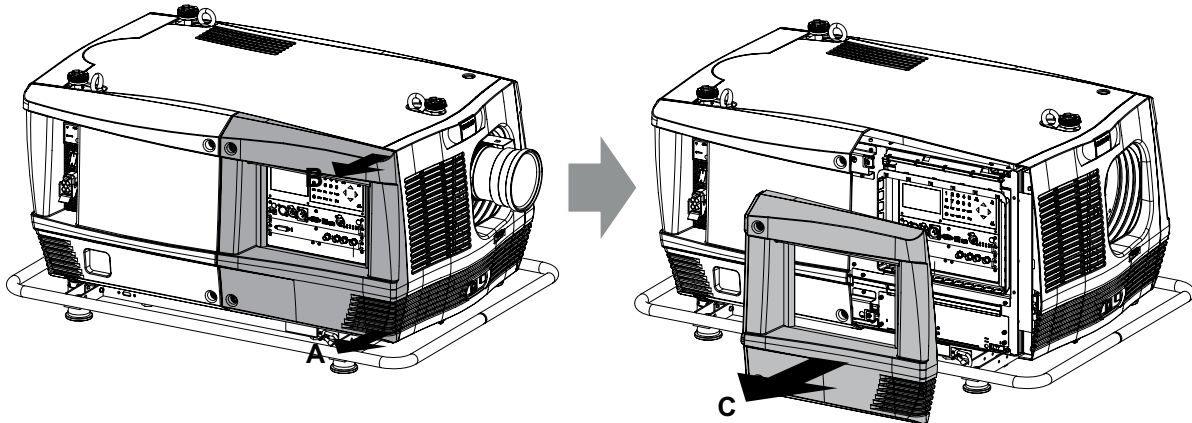


Image 16-8  
Input cover removal

## 16.5 Installation of the front cover



**WARNING:** This procedure may only be performed by qualified technical service personnel.

### Necessary tools

7 mm flat screw driver.

### How to install the front cover

1. Check if the front filter is present.
2. Ensure that no lens is mounted.
3. Install the front cover of the projector doing the following:



- a) first hook in the side of the front cover at the front filter,
- b) then gently push the other side of the front cover into position,
- c) ensure that the locking studs in the corners click into their receivers.

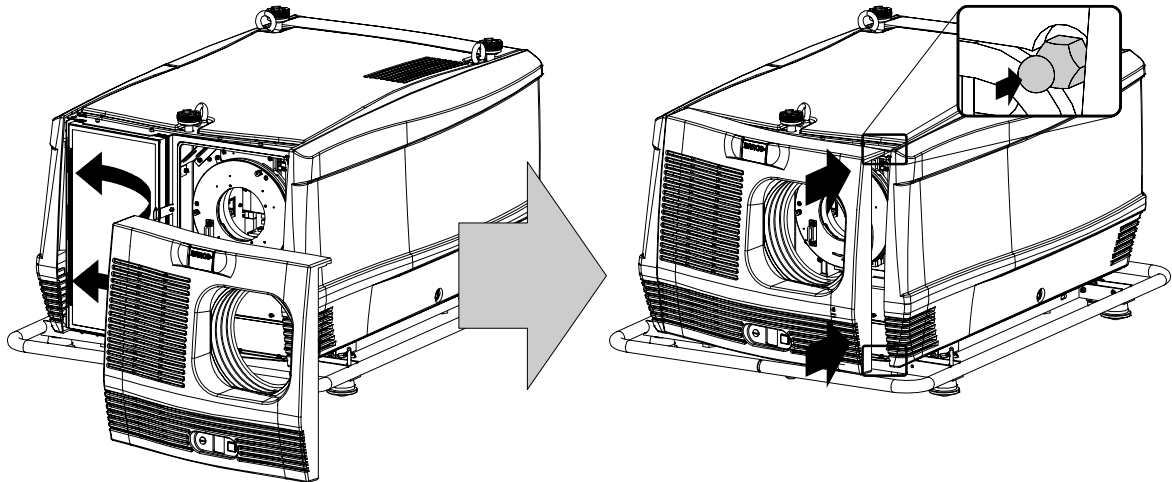


Image 16-9  
Front cover installation

4. Secure the front cover by locking the captive screw in the middle at the bottom of the front cover.

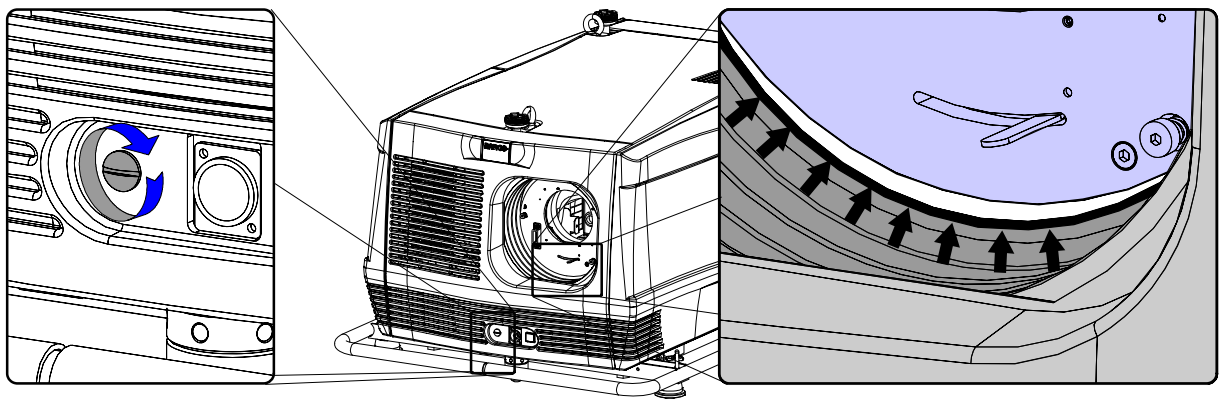


Image 16-10  
Front cover, dust ring

5. Reinstall the rubber dust ring around the lens holder.

## 16.6 Installation of the side cover



**WARNING:** This procedure may only be performed by qualified technical service personnel.

### Necessary tools

7 mm flat screw driver.

### How to install the side cover

1. Check if the bottom and top filters are present.
2. Check the pressure indicated on the internal manometer of the liquid cooling circuit. This pressure should be between 0,5 and 1 bar. If the pressure is out of range, inform the responsible and qualified technician, so he may take necessary corrective action.

## 16. Removal and installation of the projector covers

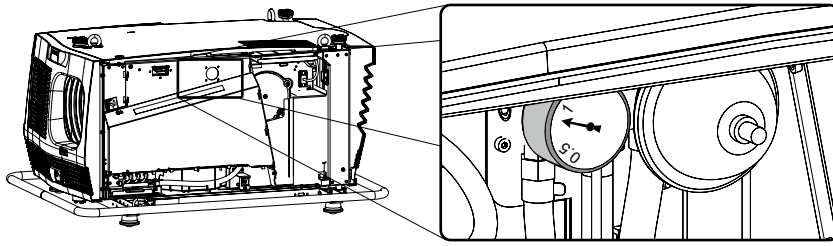


Image 16-11

3. Install the side cover of the projector doing the following:
  - a) Bring the side cover towards its final position (A),
  - b) then gently push the locking studs of the top corners (B) into their receivers,
  - c) then gently push the locking studs of the bottom corners (C) into their receivers.

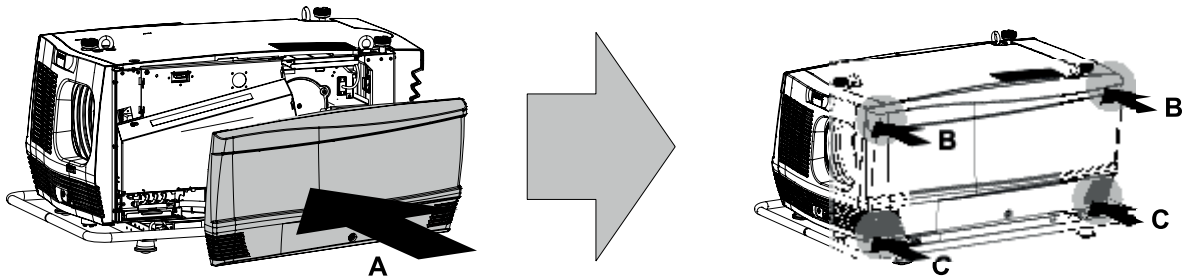


Image 16-12  
Mount side cover

4. Secure the side cover by locking the captive screw in the middle at the bottom of the side cover.

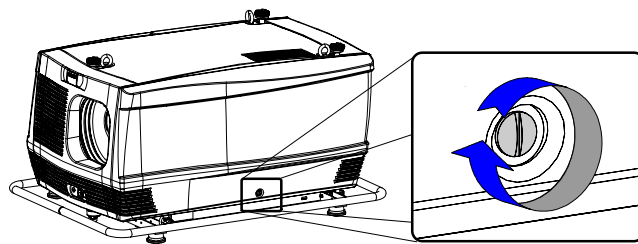


Image 16-13  
Fixate captive screw

## 16.7 Installation of the lamp cover



**WARNING:** This procedure may only be performed by qualified technical service personnel.

### Necessary tools

7 mm flat screw driver.

### How to install the lamp cover

1. Install the lamp cover of the projector as follows:
  - a) Bring the lamp cover towards its final position (A),
  - b) then gently push the locking stud at the left top corner (B) into its receiver,
  - c) then gently push the locking stud at the left bottom corner (C) into its receiver.

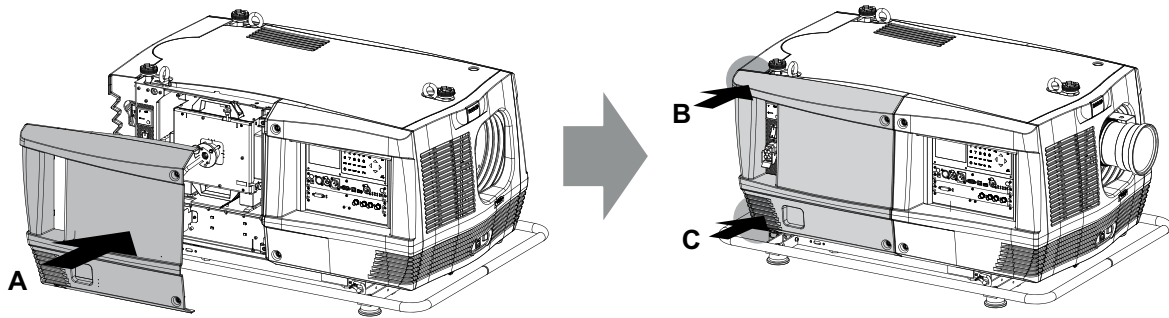


Image 16-14  
Lamp cover installation

2. Secure the lamp cover by locking the two captive screws at the right side of the lamp cover.

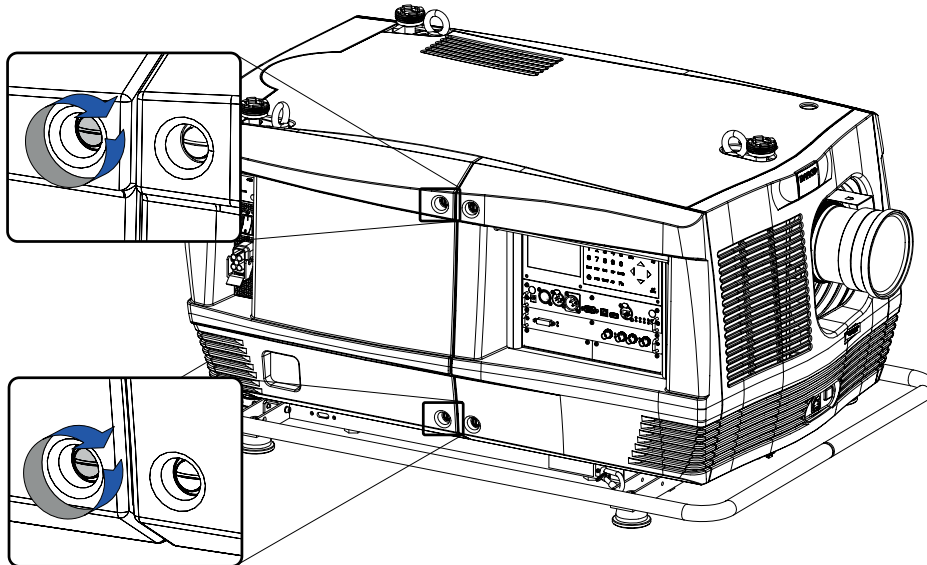


Image 16-15  
Captive screw locking

## 16.8 Installation of the input cover



**WARNING:** This procedure may only be performed by qualified technical service personnel.

### Necessary tools

7 mm flat screw driver.

### How to install the input cover

1. Install the input cover of the projector as follows:
  - a) Bring the input cover towards its final position (A),
  - b) then gently push the locking stud at the right top corner (B) into its receiver,
  - c) then gently push the locking stud at the right bottom corner (C) into its receiver.

16. Removal and installation of the projector covers

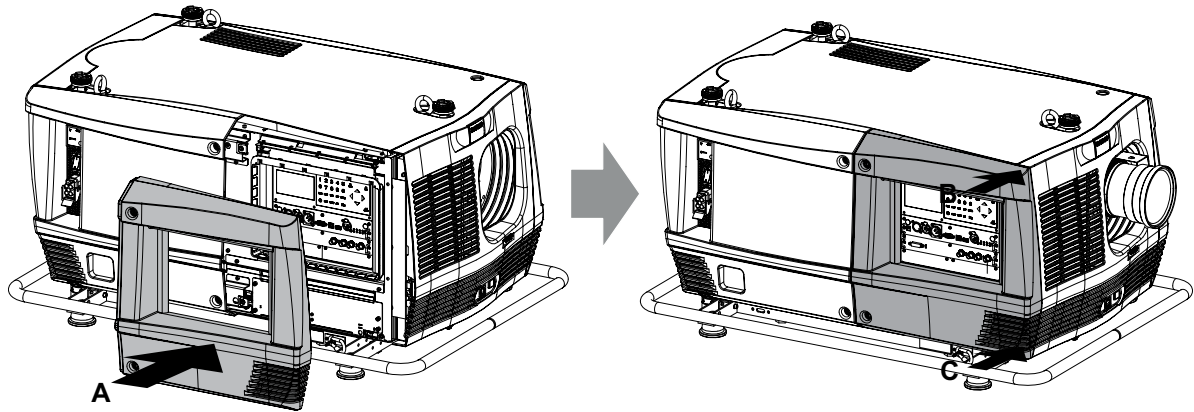


Image 16-16  
Input cover, installation

2. Secure the input cover by locking the two captive screws at the left side of the input cover.

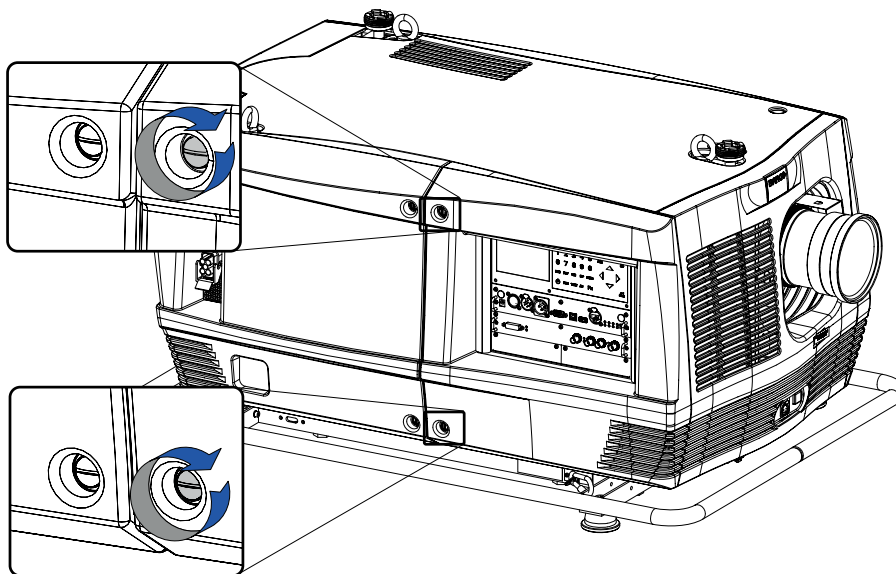


Image 16-17  
Captive screws, locking

---

# 17. SERVICING

## About this chapter

This chapter contains general servicing procedures like lamp house replacement, input unit replacement etc. These procedures may only be performed by **qualified technical service personnel**.

## Overview

- Inserting an input module
- Replacement of the dust filter on the front side
- Replacement of the dust filter on the bottom side
- Replacement of the dust filter on the top side
- Pressure verification of the liquid cooling circuit
- Removal of the lamp house
- Installation of the lamp house
- Realignment of the lamp in its reflector

## Extra service information

Extra service information for qualified service technicians can be found on Barco's Partnerzone (URL:<http://my.barco.com>). Registration is necessary.

If you are not yet registered, click on Partnerzone registration and follow the instructions. With the created login and password, it is possible to enter the partnerzone where you can find extra service information about the projector.



**WARNING: Switch off the projector and unplug the power cord before starting the procedure.**

---



**WARNING: Maximum service time is limited to 2 hours due to possible UV radiation.**

---

## 17.1 Inserting an input module

---



**WARNING: Switch off the projector and unplug the power cord before starting the procedure.**

---

### How to insert

1. Loosen both screws of the dummy cover plate (1).

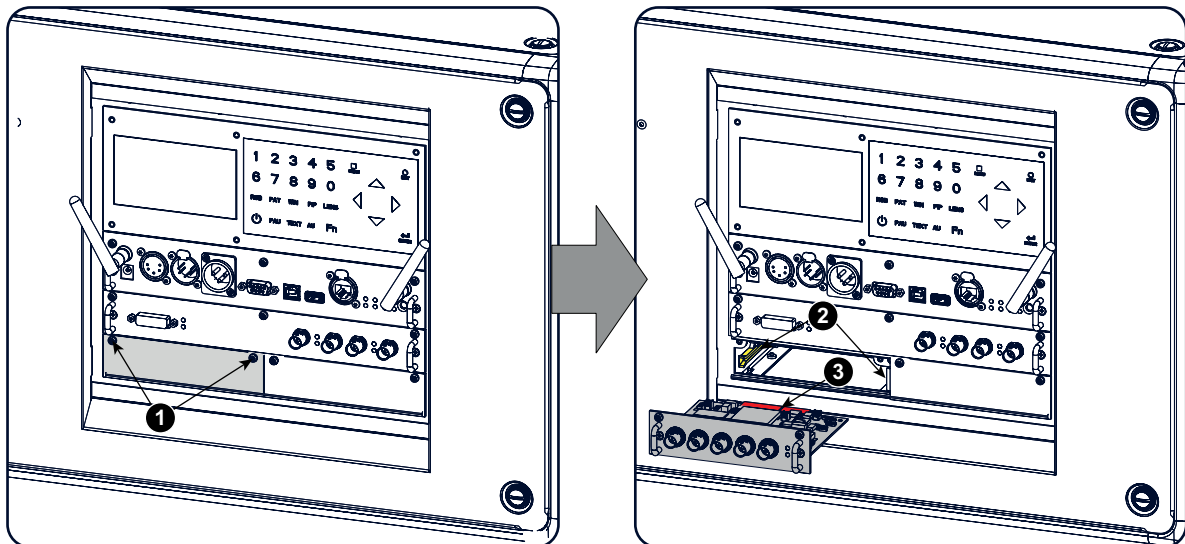


Image 17-1  
Insert input module

2. Take off the dummy cover plate.
3. Insert the new input module in its compartment.  
Make sure the module seats in its sliders (2).  
Pull in the module until the contacts (3) are fully inserted into the connectors.
4. Fixate both fixation screws.

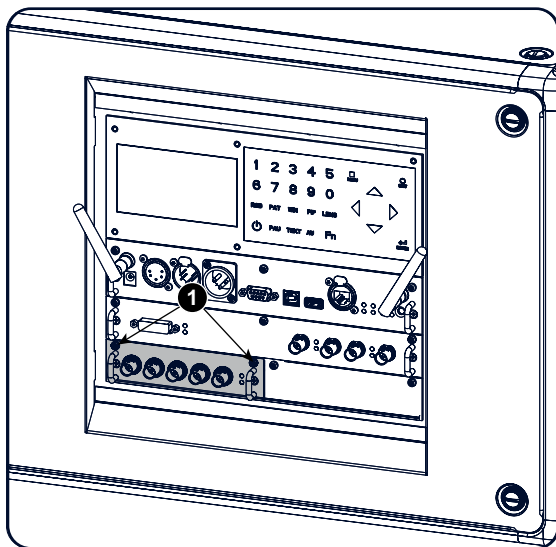


Image 17-2  
Fixate input

## 17.2 Replacement of the dust filter on the front side

### Necessary parts

New HEPA dust filter for the front side (R9854470).

### How to replace the HEPA dust filter on the front side

1. Remove the front cover of the projector, see "Removal of the front cover", page 289.
2. Remove the HEPA dust filter on the front side by pulling the two spring clamps away from the filter and then moving the filter forwards.

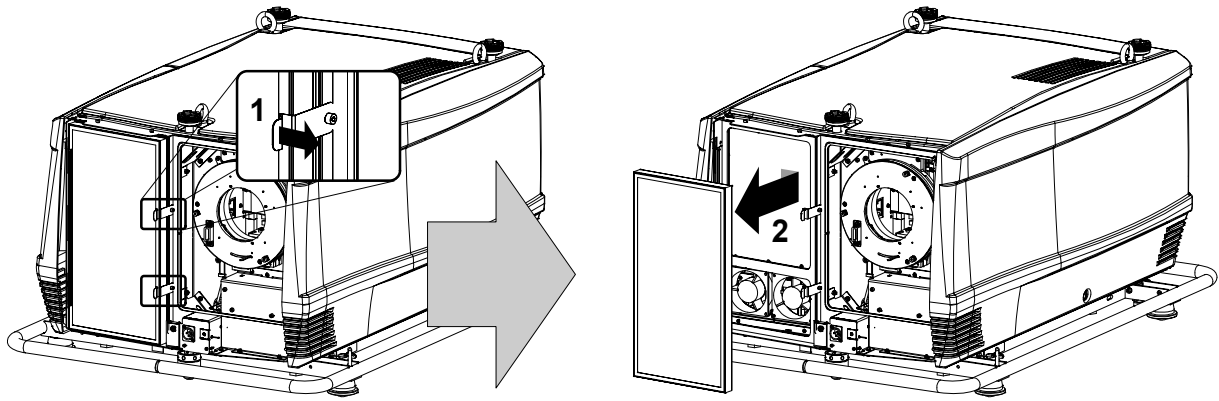


Image 17-3  
Front filter

3. Insert a new HEPA<sup>6</sup> filter by pulling the two spring clamps away and move the filter into position.  
**Caution:** Make sure that the airflow indicated on the dust filter match with the airflow of the fans.
4. Reinstall the front cover of the projector, see "Installation of the front cover", page 292.



**CAUTION:** Never install a used HEPA filter. Always install a new HEPA filter.

### 17.3 Replacement of the dust filter on the bottom side

#### Necessary parts

- New HEPA dust filter for the bottom side (R9854480).
- 2.5 mm Allen key.

#### How to replace the HEPA dust filter on the bottom side

1. Remove the side cover of the projector, see "Removal of the side cover", page 290.
2. Release (not remove) the two wedge lock screws (A) using a 2.5 mm Allen key as illustrated.

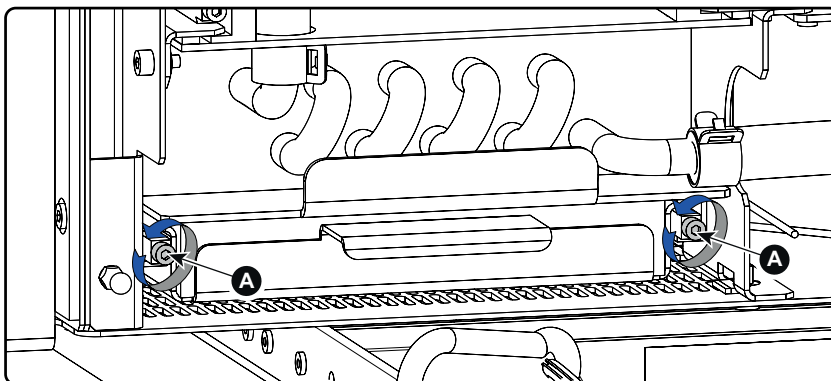


Image 17-4  
Bottom filter, lock screws

3. Remove the filter (F) on the bottom side by pulling out the filter holder (H) as illustrated.

6. High Efficiency Particulate Arrestant

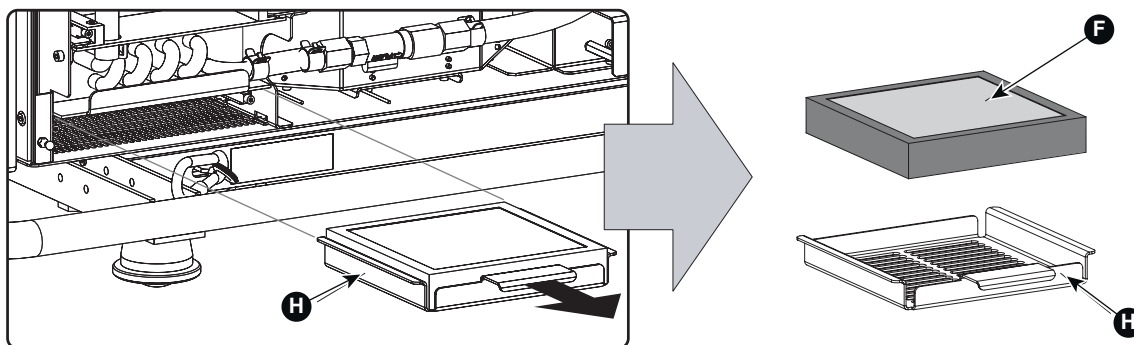


Image 17-5  
Bottom filter, remove

4. Place a new HEPA dust filter in the filter holder.  
**Caution:** Make sure that the airflow indicated on the dust filter match with the airflow of the fans.
5. Reinstall the filter holder containing the new HEPA filter.
6. Fasten the two wedge lock screws (A) using a 2.5 mm Allen key as illustrated.

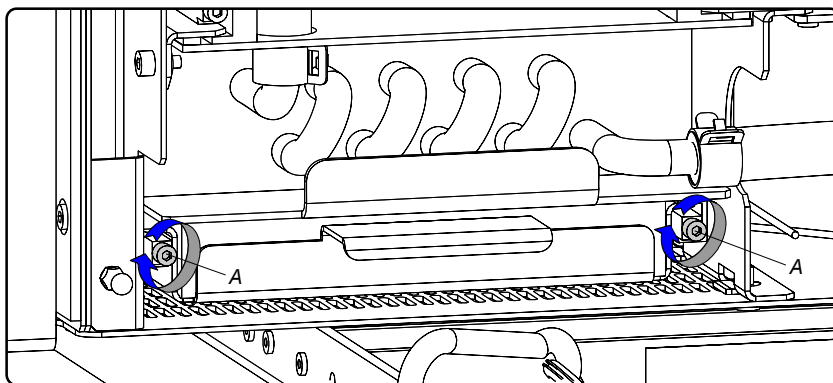


Image 17-6

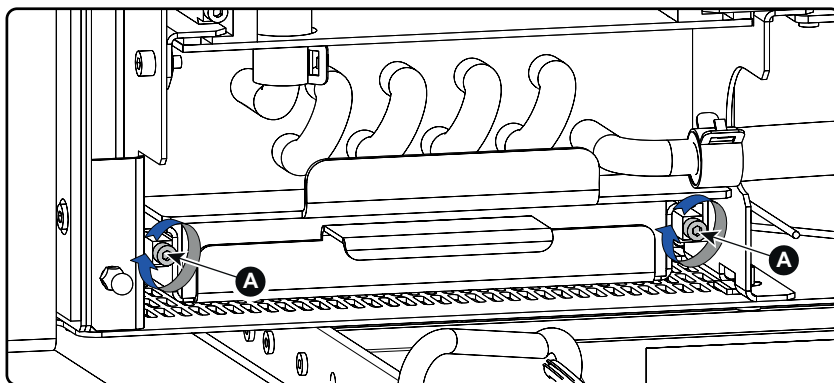


Image 17-7  
Bottom filter, fixation

7. Reinstall the side cover of the projector, see "Installation of the side cover", page 293.



**CAUTION:** Never install a used HEPA filter. Always install a new HEPA filter.

## 17.4 Replacement of the dust filter on the top side

### Necessary parts

New HEPA dust filter for the top side (R9854480).



### How to replace the HEPA dust filter on the top side

1. Remove the side cover of the projector, see "Removal of the side cover", page 290.
2. Remove the filter (F) on the top side by pulling out the filter holder (H) as illustrated.

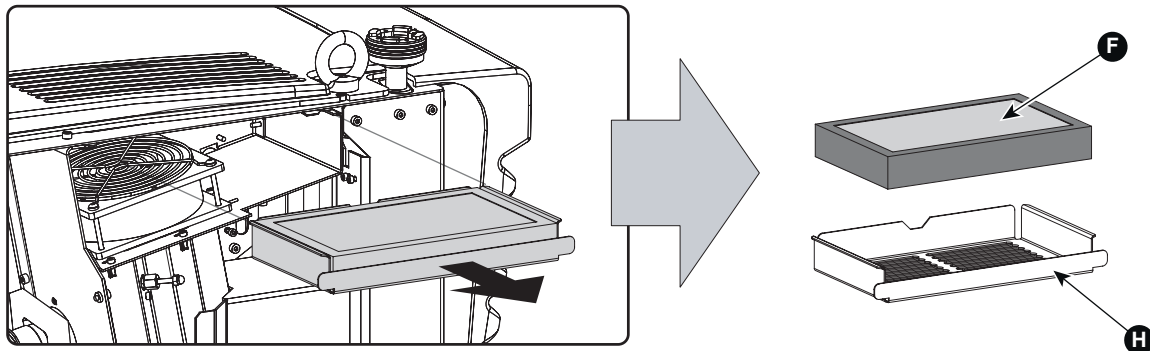


Image 17-8  
Top filter

3. Place a new HEPA dust filter in the filter holder.  
**Caution:** Make sure that the airflow indicated on the dust filter match with the airflow of the fans.
4. Reinstall the filter holder containing the new HEPA filter.
5. Reinstall the side cover of the projector, see "Installation of the side cover", page 293.



**CAUTION:** Never install a used HEPA filter. Always install a new HEPA filter.

## 17.5 Pressure verification of the liquid cooling circuit



**CAUTION:** The pressure of the Liquid Cooling Circuit should be checked regularly. This pressure, indicated on the internal manometer, should be between 0,5 and 1 bar. If not, corrective action should be taken by qualified technical service personnel.

### How to check the pressure of the liquid cooling circuit

1. Remove the side cover of the projector, see "Removal of the side cover", page 290.
2. Look through the small window and check the pressure indicated on the internal manometer of the liquid cooling circuit.

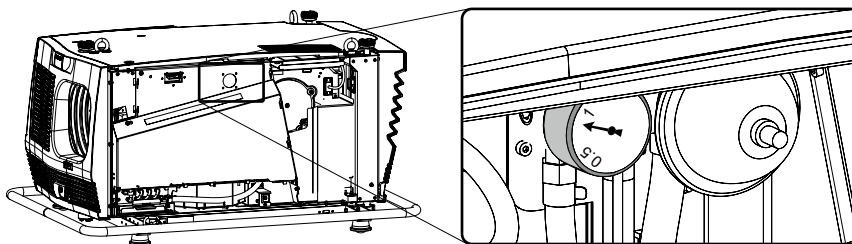


Image 17-9  
Pressure check

3. This pressure should be between 0,5 and 1 bar. If the pressure, indicated on the manometer, is out of range, inform the responsible and qualified technicians, so they may take necessary corrective action.
4. Reinstall the side cover of the projector, see "Installation of the side cover", page 293.

## 17.6 Removal of the lamp house



**WARNING:** This procedure may only be performed by qualified technical service personnel.



**CAUTION:** Never attempt to disassemble the lamp from its housing or to dispose of it. Return it to Barco. Due to its high internal pressure, the lamp may explode in either hot or cold states if improperly handled.

### Necessary tools

7 mm flat screw driver.

### How to remove the lamp house

1. Switch off the projector and unplug the power cord at the projector side.
2. Remove the lamp cover, see "Removal of the lamp cover", page 291.
3. Release the three spring lock screws of the lamp house as illustrated.

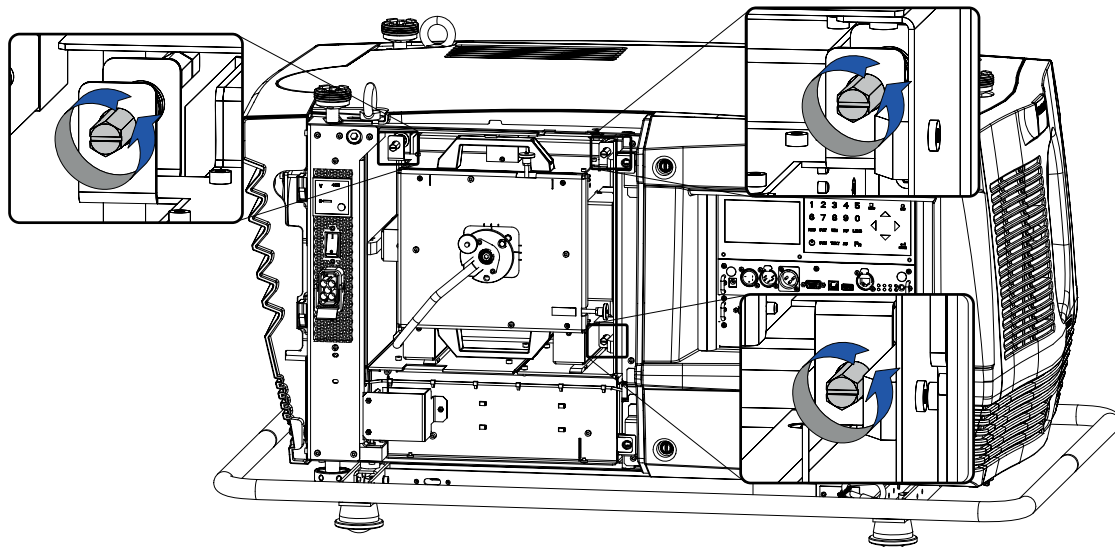


Image 17-10  
Unlock lamp house

4. Clasp the lamp house by the handles and pull the lamp house out of the projector.

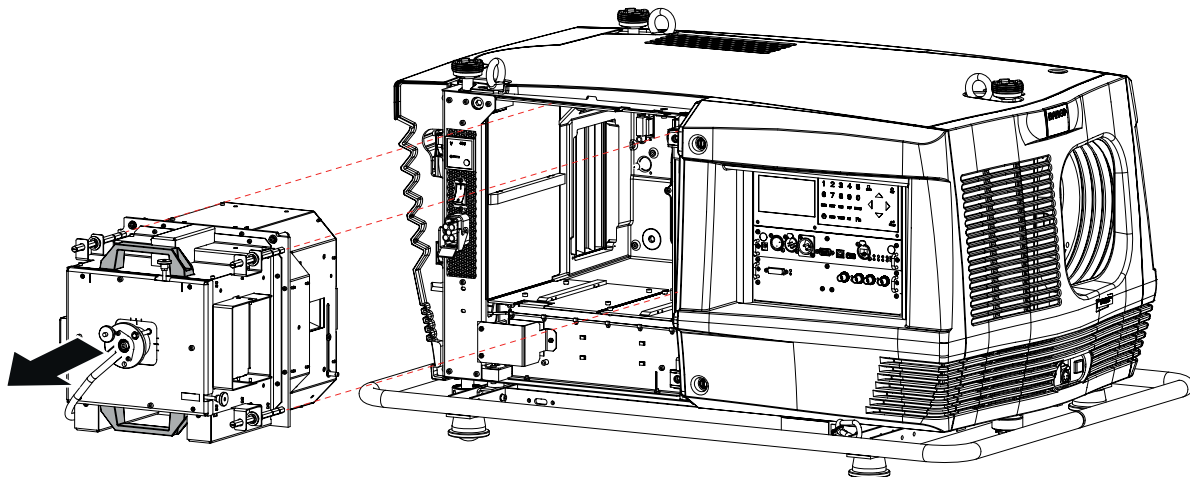


Image 17-11  
Lamp house removal



While starting up the projector, the electronics detect if a lamp is installed. If no lamp is installed, it is not possible to start up the projector.

## 17.7 Installation of the lamp house



**WARNING:** This procedure may only be performed by qualified technical service personnel.



**CAUTION:** Never attempt to disassemble the lamp from its housing or to dispose of it. Return it to Barco. Due to its high internal pressure, the lamp may explode in either hot or cold states if improperly handled.

### Necessary tools

7 mm flat screw driver.

### How to install the lamp house of the projector ?

1. Ensure the projector is switched off and the power cord at the projector side is unplugged.
2. Remove the lamp cover, if not removed yet. See "Removal of the lamp cover", page 291.
3. Clasp the lamp house by its handles and gently slide the lamp house into its socket. Note that the compartment is provided with guides (G) to position the lamp house correctly.

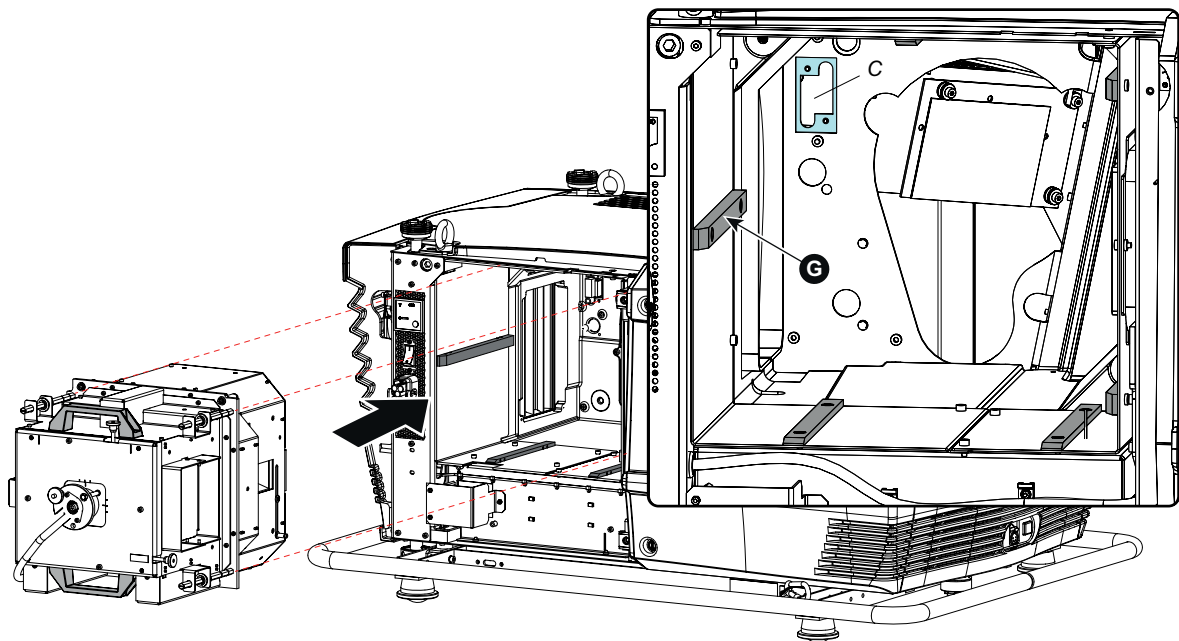


Image 17-12  
Insert lamp house

4. Push the lamp house forward until it slides fully into the projector.
5. Secure the correct position of the lamp house by tightening all three spring lock screws as illustrated.

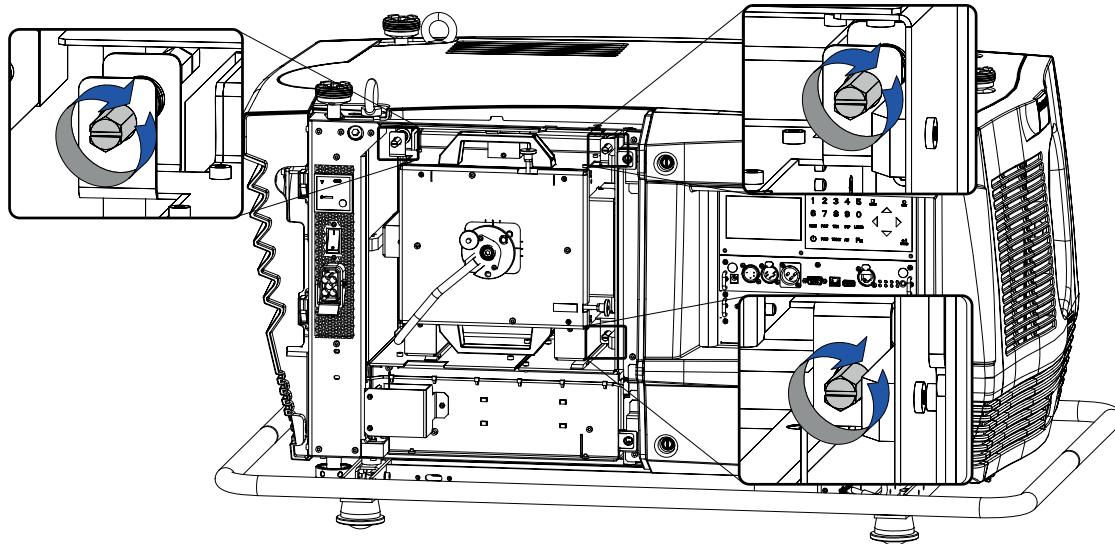


Image 17-13

6. Reinstall the lamp cover of the projector, see "Installation of the lamp cover", page 294.



While starting up the projector, the electronics detect if a lamp is installed. If no lamp is installed, it is not possible to start up the projector.

---

## 17.8 Realignment of the lamp in its reflector

---

### Why realigning the lamp ?

With longer run times, the light output of the lamp will decrease, which results in a lower light output on the screen. This light output decrease can be compensated by readjusting the Z-position of the lamp.



**WARNING:** This procedure may only be performed by qualified technical service personnel.

---

### Necessary tools

Allen key 3 mm

### How to realign the lamp in its reflector ?

1. Remove the cover of the lamp, see "Removal of the lamp cover", page 291.
2. Connect the projector to the local power net.
3. Start up the projector, enter the menu structure and select Lamp / Z-axis.
4. Loosen the Z-axis lock screw (2).
5. Carefully turn the thumb screw (1) at the rear of the lamp house clockwise for maximum light output. Once over the maximum, turn slightly counterclockwise to reach the maximum light output again.

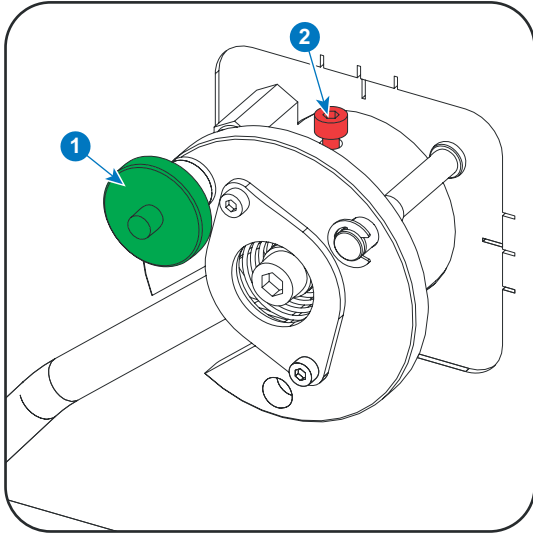


Image 17-14  
Z-axis alignment

6. Secure the Z-axis position by fastening the Z-axis lock screw.
7. Switch off the projector, wait five minutes and unplug the power cord at the projector side.
8. Reinstall the cover of the lamp, see "Installation of the lamp cover", page 294.



# A. SPECIFICATIONS

## A.1 Specifications of the HDF W22

### Overview

<b>Projector type</b>	WUXGA 3-chip DLP digital projector
<b>Technology</b>	0.96" DMD™ x3
<b>Resolution</b>	1,920 x 1,200
<b>Brightness</b>	22,000 center lumens / 20,000 ANSI lumens
<b>Contrast ratio</b>	1,900:1 (standard) / 2,200:1 (high contrast mode)
<b>Brightness uniformity</b>	90%
<b>Aspect Ratio</b>	16:10
<b>ScenergiX</b>	Horizontal and vertical edge blending
<b>Lens type</b>	TLD+
<b>Lenses</b>	0.73:1 ; 1.2:1 ; 1.25-1.6:1 ; 1.5-2.0:1 ; 2.0-2.8:1 ; 2.8-4.5:1 ; 4.5-7.5:1 ; 7.5-11.5:1
<b>Optical lens shift</b>	Vertical: -30% to +120% / Horizontal: -40% to +40% on zoom lenses (memorized)
<b>Color correction</b>	P7
<b>Lamps</b>	3.8 kW xenon
<b>Lamp lifetime</b>	1,000 Hrs
<b>Transport with lamp</b>	Yes
<b>Lamp house, quick replace</b>	Yes
<b>Customer bulb replace</b>	Yes
<b>Lamp warranty (field replace/ factory replace)</b>	90 days, 500 hours / pro rata 500 hours
<b>Sealed DLP™ core</b>	Standard
<b>Optical dowser</b>	Standard
<b>Picture-in-picture</b>	Two sources simultaneously
<b>Orientation</b>	table - ceiling - side (portrait)* - vertical * lamp door down/bottom
<b>Others</b>	can be controlled by DMX 512 console, warping
<b>DMX 512</b>	standard
<b>WARP</b>	Direct adjust OSD + toolset
<b>Integrated web server</b>	yes
<b>CLO (constant light output)</b>	Standard
<b>3D</b>	Active eyewear (optional), passive Infitec (optional), passive circular (optional), triple flash up to 200 HS
<b>Inputs</b>	DVI-I (HDCP including analog RGB YUV), SDI/HDSDI/Dual HDSDI/3G/BarcoLink
<b>Optional Inputs</b>	5-BNC RGBHV (RGBS/RGsB, YUV CS/SOY, Composite video, S-Video); DVI-I (HDCP including analog RGB YUV) + BarcoLink/SDI/HDSDI/Dual HDSDI/3G; 3D active input (HDMI/DisplayPort) feat. SENSIO 3D
<b>Input Resolutions</b>	From NTSC up to QXGA (2,048 x 1,536)
<b>Max. pixel clock</b>	200 MHz
<b>Software tools</b>	Projector Toolset + Android app
<b>Control</b>	XLR wired + IR, RS232, Wifi, GSM (opt)
<b>Network connection</b>	10/100 base-T, RJ-45 connection, Wifi (optional)
<b>Power requirements</b>	200-240V / 50-60Hz

## A. Specifications

<b>Max. power consumption</b>	4,000W / STBY < 10W
<b>Noise level (typical at 25°C/77°F)</b>	58dB(A)
<b>Operational ambient temperature</b>	0-40°C / 32°-104°F
<b>Operational humidity</b>	0-80% (non condens)
<b>Dissipation BTU</b>	Max. 13660 BTU/h
<b>Dimensions (WxLxH)</b>	707 x 1,025 x 548mm / 27.83 x 40.35 x 21.57 inches
<b>Weight</b>	99kg (218.25lbs)
<b>Shipping Dimensions</b>	(LxWxH) 1,200 x 980 x 760 mm / 47.24 x 38.58 x 29.92 inches
<b>Shipping Weight from Factory</b>	151kg (333lbs)
<b>Standard accessories</b>	Power cord; wireless/XLR wired rugged remote control, bottom rigging kit/clamps
<b>Certifications</b>	Compliant with UL60950-1 and EN60950-1 complies with FCC rules & regulations, part 15 Class A and CE EN55022 Class A, RoHS
<b>Warranty</b>	2 years standard, extendable up to 5 years

## A.2 Specifications of the HDF W26

### Overview

<b>Projector type</b>	WUXGA 3-chip DLP digital projector
<b>Technology</b>	0.96" DMD™ x3
<b>Resolution</b>	1,920 x 1,200
<b>Brightness</b>	26,000 center lumens / 24,000 ANSI lumens
<b>Contrast ratio</b>	1,900:1 (standard) / 2,200:1 (high contrast mode)
<b>Brightness uniformity</b>	90%
<b>Aspect Ratio</b>	16:10
<b>ScenergiX</b>	Horizontal and vertical edge blending
<b>Lens type</b>	TLD+
<b>Lenses</b>	0.73:1 ; 1.2:1 ; 1.25-1.6:1 ; 1.5-2.0:1 ; 2.0-2.8:1 ; 2.8-4.5:1 ; 4.5-7.5:1 ; 7.5-11.5:1
<b>Optical lens shift</b>	Vertical: -30% to +120% / Horizontal: -40% to +40% on zoom lenses (memorized)
<b>Color correction</b>	P7
<b>Lamps</b>	3.8 kW xenon
<b>Lamp lifetime</b>	750 Hrs
<b>Transport with lamp</b>	Yes
<b>Lamp house, quick replace</b>	Yes
<b>Customer bulb replace</b>	Yes
<b>Lamp warranty (field replace/ factory replace)</b>	90 days, 500 hours / pro rata 500 hours
<b>Sealed DLP™ core</b>	Standard
<b>Optical dowser</b>	Standard
<b>Picture-in-picture</b>	Two sources simultaneously
<b>Orientation</b>	table - ceiling - side (portrait)* - vertical * lamp door down/bottom
<b>Others</b>	can be controlled by DMX 512 console, warping
<b>DMX 512</b>	standard
<b>WARP</b>	Direct adjust OSD + toolset
<b>Integrated web server</b>	yes
<b>CLO (constant light output)</b>	Standard



<b>3D</b>	Active eyewear (optional), passive Infitec (optional), passive circular (optional), triple flash up to 200Hz
<b>Inputs</b>	DVI-I (HDCP including analog RGB YUV), SDI/HDSDI/Dual HDSDI/3G/BarcoLink
<b>Optional Inputs</b>	5-BNC RGBHV (RGBS/RGsB, YUV CS/SOY, Composite video, S-Video); DVI-I (HDCP including analog RGB YUV) + BarcoLink/SDI/HDSDI/Dual HDSDI/3G; 3D active input (HDMI/DisplayPort) feat. SENSIO 3D
<b>Input Resolutions</b>	From NTSC up to QXGA (2,048 x 1,536)
<b>Max. pixel clock</b>	200 MHz
<b>Software tools</b>	Projector Toolset + Android app
<b>Control</b>	XLR wired + IR, RS232, Wifi, GSM (opt)
<b>Network connection</b>	10/100 base-T, RJ-45 connection, Wifi (optional)
<b>Power requirements</b>	200-240V / 50-60Hz
<b>Max. power consumption</b>	4,550W / STBY < 10W
<b>Noise level (typical at 25°C/77°F)</b>	60dB(A)
<b>Operational ambient temperature</b>	0-40°C / 32°-104°F
<b>Operational humidity</b>	0-80% (non condens)
<b>Dissipation BTU</b>	Max. 15,593 BTU/h
<b>Dimensions (WxLxH)</b>	707 x 1,025 x 548mm / 27.83 x 40.35 x 21.57 inches
<b>Weight</b>	99kg (218.25lbs)
<b>Shipping Dimensions</b>	(LxWxH)1,200 x 980 x 760 mm / 47.24 x 38.58 x 29.92 inches
<b>Shipping Weight from Factory</b>	151kg (333lbs)
<b>Standard accessories</b>	Power cord; wireless/XLR wired rugged remote control, bottom rigging kit/clamps
<b>Certifications</b>	Compliant with UL60950-1 and EN60950-1 complies with FCC rules & regulations, part 15 Class A and CE EN55022 Class A, RoHS
<b>Warranty</b>	2 years standard, extendable up to 5 years

### A.3 Specifications of the HDF W30 Flex

#### Overview

<b>Projector type</b>	WUXGA 3-chip DLP digital projector
<b>Technology</b>	0.96" DMD™ x3 sealed DLP core
<b>Resolution</b>	1,920 x 1,200 - 16:10 aspect ratio
<b>Brightness</b>	30,000 center lumens / 28,000 ANSI lumens
<b>Contrast ratio</b>	1,900:1 (standard) / 2,200:1 (high contrast mode)
<b>Brightness uniformity</b>	90%
<b>ScenergiX</b>	Horizontal and vertical edge blending
<b>Lenses</b>	TLD+ 0.67:1,1.14:1,1.16-1.49:1,1.39-1.87:1,1.87-2.56:1,2.56-4.17:1,4.17-6.95:1, 6.93-10.3:1
<b>Optical lens shift</b>	V: -30% to +120% / H: -40% to +40% on zoom lenses (memorized)
<b>Color correction</b>	P7
<b>Lamps</b>	4.0 kW xenon
<b>Lamp lifetime</b>	600 Hrs
<b>Transport with lamp</b>	Yes
<b>Lamp house, quick replace</b>	Yes
<b>Customer bulb replace</b>	Yes
<b>Lamp warranty (field replace/ factory replace)</b>	90 days, 500 hours / pro rata 500 hours
<b>Optical dowser</b>	Standard

## A. Specifications

<b>Picture-in-picture</b>	Two sources simultaneously
<b>Orientation</b>	table - ceiling - side (portrait)* - vertical / * lamp door down/bottom
<b>DMX 512</b>	standard
<b>WARP</b>	Direct adjust OSD + toolset
<b>Integrated web server</b>	Yes
<b>CLO (constant light output)</b>	Standard
<b>3D</b>	Triple flash up to 200Hz/Optional: active eyewear, passive Infitec, passive circular
<b>Inputs</b>	DVI-I (HDCP including analog RGB YUV), SDI/HDSDI/Dual HDSDI/3G/BarcoLink
<b>Optional Inputs</b>	5-BNC RGBHV (RGSB/RGsB, YUV CS/SOY, Composite video, S-Video); DVI-I (HDCP including analog RGB YUV) + BarcoLink/SDI/HDSDI/Dual HDSDI/3G; 3D active input (HDMI/DisplayPort) feat. SENSIO 3D
<b>Input Resolutions</b>	From NTSC up to QXGA (2,048 x 1,536)
<b>Max. pixel clock</b>	200 MHz
<b>Software tools</b>	Projector Toolset + Android app + iOS app
<b>Control</b>	XLR wired + IR, RS232, Wifi, GSM (opt)
<b>Network connection</b>	10/100 base-T, RJ-45 connection, Wifi (optional)
<b>Power requirements</b>	200-240V / 50-60Hz
<b>Max. power consumption</b>	4,550W / STBY < 10W
<b>Noise level (typical at 25°C/77°F)</b>	60dB(A)
<b>Operational ambient temperature</b>	0-40°C / 32°-104°F
<b>Operational humidity</b>	0-80% (non condens)
<b>Dissipation BTU</b>	Max. 15,593 BTU/h
<b>Dimensions (WxLxH)</b>	707 x 1,025 x 548mm / 27.83 x 40.35 x 21.57 inches
<b>Shipping Dimensions</b>	(LxWxH)1,200 x 980 x 760 mm / 47.24 x 38.58 x 29.92 inches
<b>Weight</b>	99kg (218.25lbs)/shipping weight from factory: 151kg (333lbs)
<b>Standard accessories</b>	Power cord,wireless/XLR wired rugged remote control,bottom rigging kit/clamps
<b>Certifications</b>	UL60950-1 and EN60950-1,FCC rules & regulations,part 15 Class A and CE EN55022 Class A,RoHS
<b>Warranty</b>	2 years standard, extendable up to 5 years

## A.4 Technical Regulations

### Certificates



Image A-1  
EAC mark



Image A-2  
RoHS



Image A-3  
RoHS OK



Image A-4  
CE mark

## B. DIMENSIONS

### Overview

- Dimensions of the HDF series projector
- Dimensions of the HDF series flight case

### B.1 Dimensions of the HDF series projector

#### Dimensions

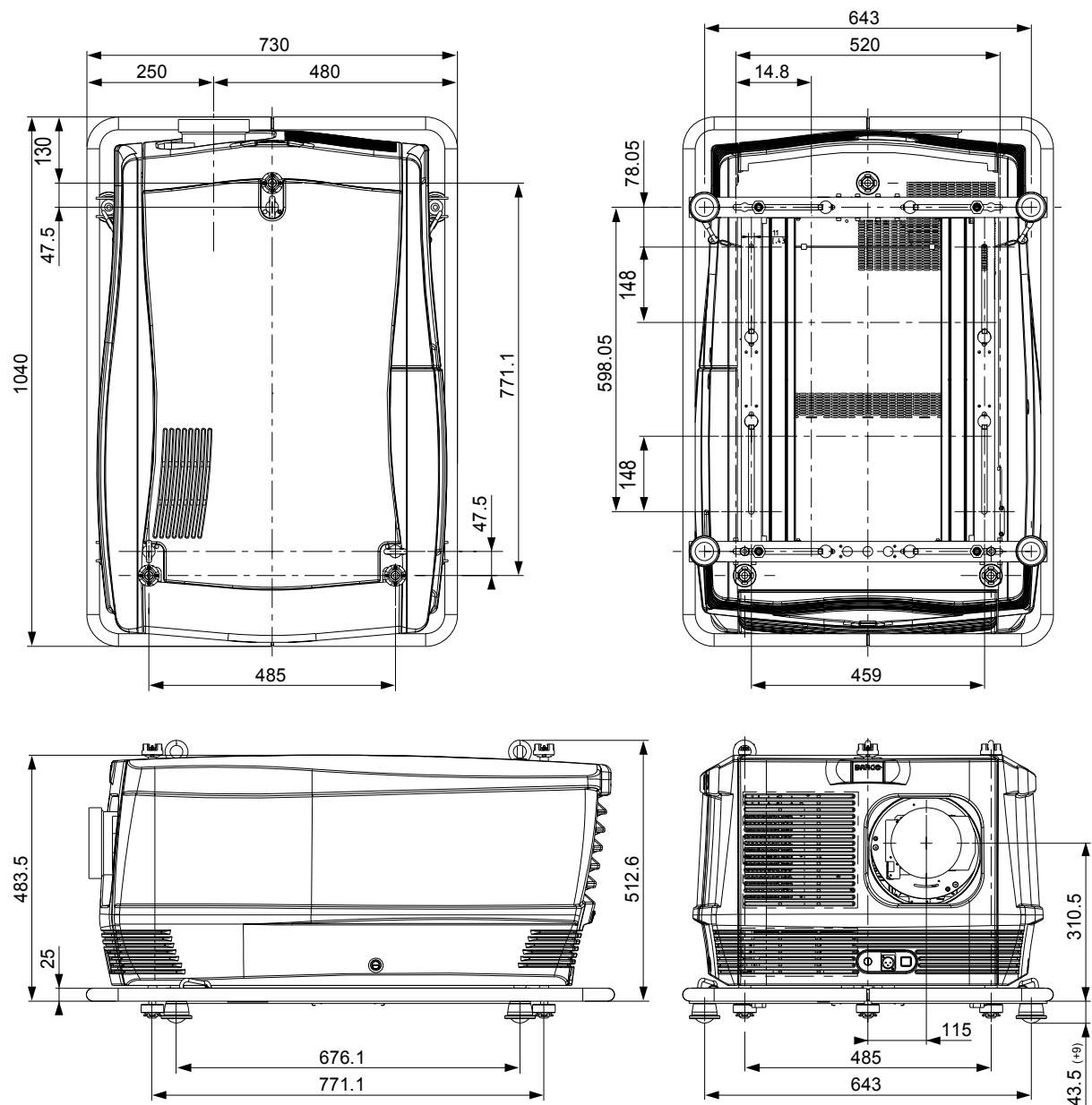


Image B-1  
Dimensions given in millimeters.

Point of gravity

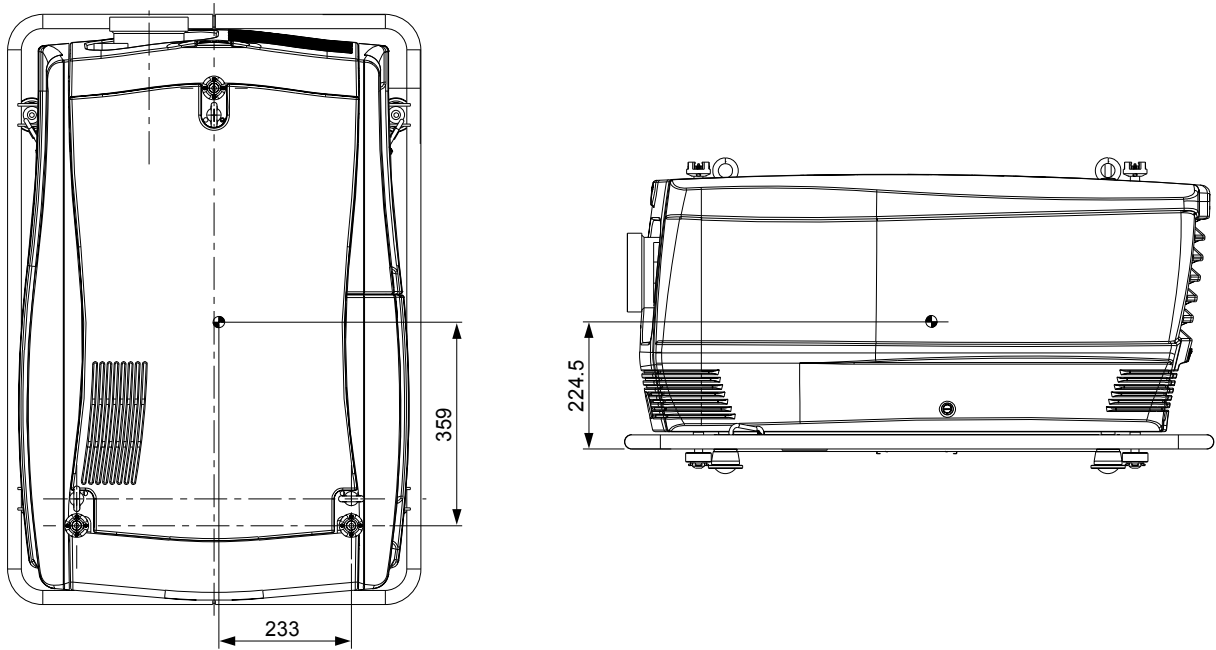


Image B-2  
Dimensions given in millimeters.

B.2 Dimensions of the HDF series flight case

Dimensions

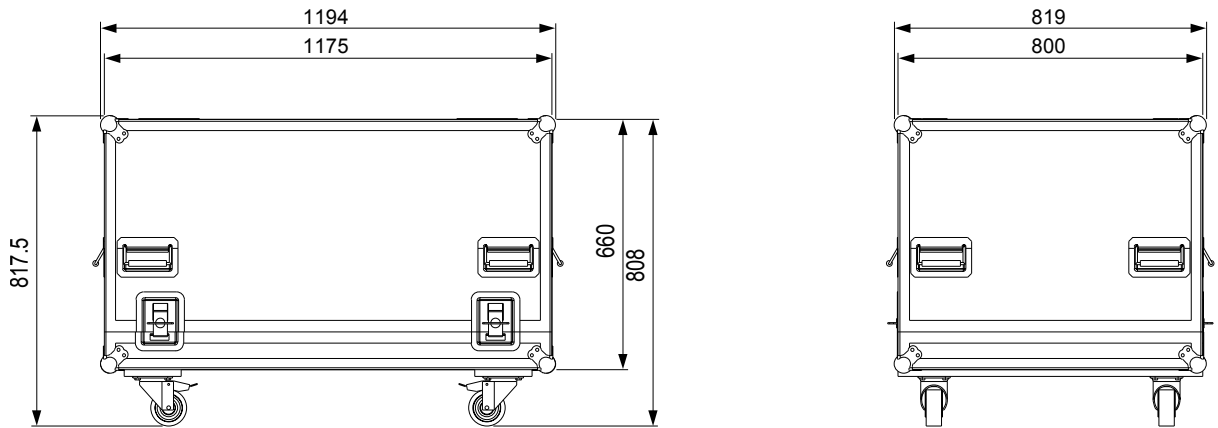


Image B-3  
Dimensions given in millimeters.

## C. STANDARD SOURCE FILES

### C.1 Table overview

#### Table overview

The following standard image files are pre-programmed in the projector.

Name <sup>7</sup>	Fvert Hz <sup>8</sup>	FHor kHz <sup>9</sup>	Fpix MHz <sup>10</sup>	Ptot <sup>11</sup>	Pact <sup>12</sup>	Ltot <sup>13</sup>	Lact <sup>14</sup>
640x350@85	85,079	37,860	31,500	832	640	445	350
640x400@85	85,079	37,860	31,500	832	640	445	400
640x480@60	59,940	31,668	25,175	800	640	525	480
640x480@72	72,888	30,288	19,687	832	640	520	480
640x480@75	74,999	37,500	31,500	840	640	500	480
640x480@85	85,009	43,270	36,000	832	640	509	480
720x400@85	85,040	37,928	35,500	936	720	446	400
800x600@50	50,000	31,250	32,000	1024	800	625	600
800x600@56	56,251	35,157	36,001	1024	800	625	600
800x600@60	60,317	37,879	40,000	1056	800	628	600
800x600@72	72,188	48,077	50,000	1040	800	666	600
800x600@75	75,001	46,876	49,501	1056	800	625	600
800x600@85	85,062	53,674	56,250	1048	800	631	600
848x480@60	60,000	31,020	33,750	1088	848	517	480
1024x768@43i	86,957	35,522	44,900	1264	1024	817	768
1024x768@50	50,000	40,000	53,437	1336	1024	800	768
1024x768@60	60,004	48,363	65,000	1344	1024	806	768
1024x768@70	70,068	56,475	74,999	1328	1024	806	768
1024x768@75	75,030	60,024	78,751	1312	1024	800	768
1024x768@85	84,996	68,677	94,499	1376	1024	808	768
1152x864@75	74,999	67,499	107,999	1600	1152	900	864
1280x768@60	59,870	47,776	79,499	1664	1280	798	768
1280x768@75	74,992	60,288	102,249	1696	1280	805	768
1280x768@85	84,838	68,634	117,502	1712	1280	809	768
1280x768RB@60	59,994	47,396	68,250	1440	1280	790	768
1280x800@60	59,910	49,306	71,000	1480	1280	823	800
1280x960@50	50,000	50,000	90,000	1800	1280	1000	960
1280x960@60	59,999	59,999	107,998	1800	1280	1000	960
1280x960@85	85,005	85,940	128,505	1728	1280	1011	960
1280x1024@50	50,000	52,801	89,550	1696	1280	1056	1024
1280x1024@60	60,018	63,980	107,997	1688	1280	1066	1024
1280x1024@75	75,023	79,974	134,997	1688	1280	1066	1024

7. Name: name of file, contains the settings.  
8. Fvert Hz: vertical frame frequency of the source  
9. FHor kHz: horizontal frequency of the source  
10. Fpix MHz: pixel frequency  
11. Ptot : total pixels on one horizontal line.  
12. Pact: active pixels on one horizontal line.  
13. Ltot: total lines in one field  
14. Lact: active lines in one field.

C. Standard source files

Name <sup>7</sup>	Fvert Hz <sup>8</sup>	FHor kHz <sup>9</sup>	Fpix MHz <sup>10</sup>	Ptot <sup>11</sup>	Pact <sup>12</sup>	Ltot <sup>13</sup>	Lact <sup>14</sup>
1280x1024@85	85,027	91,149	157,506	1728	1280	1072	1024
1360x768@60	60,15	47,752	85,500	1792	1366	798	768
1366x768@60	59,790	47,712	85,500	1792	1366	798	768
1400x1050@50	50,000	54,500	94,618	1736	1400	1090	1050
1400x1050@60	59,979	65,317	121,751	1864	1400	1089	1050
1400x1050@75	74,866	82,277	155,998	1896	1400	1099	1050
1400x1050@85	84,958	93,879	179,497	1912	1400	1105	1050
1400x1050RB@60	59,946	64,742	100,997	1560	1400	1080	1050
1440x900@60	59,887	55,935	106,500	1904	1440	934	900
1440x900@75	74,984	70,635	136,750	1936	1440	942	900
1440x900@85	84,842	80,430	157,000	1952	1440	948	900
1440x900RB@60	59,901	55,469	88,750	1600	1440	926	900
1600x900RB@60	60,000	60,000	108,000	1800	1600	1000	900
1600x1200@50	50,000	62,500	135,000	2160	1600	1250	1200
1600x1200@60	60,001	75,002	162,004	2160	1600	1250	1200
1600x1200@65	64,998	81,248	175,496	2160	1600	1250	1200
1600x1200@70	69,997	87,497	188,993	2160	1600	1250	1200
1600x1200@75	74,998	93,747	202,414	2160	1600	1250	1200
1600x1200@85	84,998	106,247	229,494	2160	1600	1250	1200
1680x1050@60	59,954	65,290	146,250	2240	1680	1089	1050
1680x1050@75	74,892	82,306	187,000	2272	1680	1099	1050
1680x1050@85	84,941	93,859	214,750	2288	1680	1105	1050
1680x1050RB@60	59,883	64,674	119,000	1840	1680	1080	1050
1792x1344@60	60,000	83,640	204,751	2448	1792	1394	1344
1792x1344@75	74,996	106,270	260,999	2456	1792	1417	1344
1856x1392@60	59,995	86,333	218,251	2528	1856	1439	1392
1920x1140@60	60,001	90,001	234,002	2600	1920	1500	1140
1920x1200@50	50,000	61,816	158,250	2560	1920	1238	1200
1920x1200@60	59,883	74,555	193,235	2592	1920	1245	1200
1920x1200RB@60	59,952	74,041	154,000	2080	1920	1235	1200
1920x1440@60	60,001	90,001	234,002	2600	1920	1500	1200
2048x1080RB@50	50,000	56,250	139,948	2488	2048	1125	1080
2048x1080RB@60	60,000	67,500	157,140	2328	2048	1125	1080
2048x1536RB@60	59,980	94,769	209,250	2208	2048	1580	1536
hd-1280x720@24p	24,000	18,000	74,250	4125	1280	750	720
hd-1280x720@25p	25,000	18,750	74,250	3960	1280	750	720
hd-1280x720@30p	30,000	22,500	74,250	3300	1280	750	720
hd-1280x720@50p	60,000	37,500	74,250	1980	1280	750	720
hd-1280x720@60p	60,000	45,000	74,250	1650	1280	750	720
hd-1920x1035@2997i	59,94	33,176	74,176	2200	1920	562	517
hd-1920x1035@30i	60,000	33,750	74,250	2200	1920	562	517
hd-1920x1080@24p	24,000	27,000	74,250	2750	1920	1125	1080
hd-1920x1080@24sf	48,00038,	27,000	74,250	2750	1920	562	540
hd-1920x1080@25i	50,000	28,125	74,250	2640	1920	562	540
hd-1920x1080@25p	25,000	28,125	74,250	2640	1920	1125	1080

Name <sup>7</sup>	Fvert Hz <sup>8</sup>	FHor kHz <sup>9</sup>	Fpix MHz <sup>10</sup>	Ptot <sup>11</sup>	Pact <sup>12</sup>	Ltot <sup>13</sup>	Lact <sup>14</sup>
hd-1920x1080@30i	60,000	33,750	74,250	2200	1920	562	540
hd-1920x1080@30p	30,000	33,750	74,250	2200	1920	1125	1080
hd-1920x1080@29,97	59,94	33,716	74,176	2200	1920	562	540
hd-1920x1080_2@25i	50,000	31,25	74,250	2376	1920	625	540
hd-1920x1080@50p	50,000	56,250	148,500	2640	1920	1125	1080
hd-1920x1080@60p	60,000	67,500	148,500	2200	1920	1125	1080
VIDEO525	59,940	15,734	13,500	858	720	262	242
VIDEO525p	59,940	31,469	27,000	858	720	525	484
VIDEO625	50,000	15,625	13,500	864	720	312	288
VIDEO625p	50,000	31,250	27,000	864	720	625	576

Table C-1





## D. DMX CHART

### Overview

- DMX chart, Basic
- DMX chart, Full
- DMX chart, Extended

### D.1 DMX chart, Basic

#### Overview

Channel	Function	Value	Default	Action
1	Intensity	0 - 5	255	Mechanical shutter closed
		6 - 255		Electronic contrast on output
2	Function select	0 - 7	0	No function
		8 - 15		Activate layout 1 (Main full screen) (If held for 2 seconds)
		16 - 23		Activate layout 2 (PiP top right) (If held for 2 seconds)
		24 - 31		Activate layout 3 (Split top bottom) (If held for 2 seconds)
		32 - 39		Activate layout 4 (Split left right) (If held for 2 seconds)
		40 - 47		Activate layout 5 (If held for 2 seconds)
		48 - 55		Activate layout 6 (If held for 2 seconds)
		56 - 63		Activate layout 7 (If held for 2 seconds)
		64 - 71		Activate layout 8 (If held for 2 seconds)
		72 - 79		Activate layout 9 (If held for 2 seconds)
		80 - 87		Activate layout 10 (If held for 2 seconds)
		88 - 95		Input 1 (If held for 2 seconds)
		96 - 103		Input 2 (If held for 2 seconds)
		104 - 111		Input 3 (If held for 2 seconds)
		112 - 119		Input 4 (If held for 2 seconds)
		120 - 207		No function
		208 - 215		Power On / Lamp On (If held for 5 seconds)
		216 - 223		Stand by / lamp Off (If held for 5 seconds)
		224 - 231		XLR output voltage On (if held for 5 seconds)
		232 - 239		XLR output voltage Off (if held for 5 seconds)
240 - 255	No function			

### D.2 DMX chart, Full

#### Overview

Channel	Function	Value	Default	Action
1	Intensity	0 - 5	255	Mechanical shutter closed
		6 - 255		Electronic contrast on output
2	Brightness	0 - 255	128	Adjusts the brightness between 0 and 100% on input
3	Contrast	0 - 255	128	Adjust the contrast between 0 and 100% on input

## D. DMX chart

Channel	Function	Value	Default	Action
4	Input selection	0 - 87	0	No function
		88 - 95		Input 1 (if held for 2 seconds)
		96 - 103		Input 2 (if held for 2 seconds)
		104 - 111		Input 3 (if held for 2 seconds)
		112 - 119		Input 4 (if held for 2 seconds)
		120 - 255		No function
5	Function select	0 - 31	0	No function
		32 - 63		Focus motor
		64 - 95		Zoom motor
		96 - 127		Lens shift Right Left
		128 - 159		Lens shift Up Down
		160 - 191		Power On / Lamp On (together with channel 6 and 7 held in 255 for 5 sec)
		192 - 223		Stand By / Lamp Off (together with channel 6 and 7 held in 255 for 5 sec)
		224 - 255		Return lens to center position (if held for 5 seconds)
6	Motor Go >>	0 - 31	0	Stop
		32 - 63		Run
		64 - 223		No function
		224 - 255		Move lens to maximum position
7	Motor Go <<	0 - 31	0	Stop
		32 - 63		Run
		64 - 223		No function
		224 - 255		Move lens to minimum position
8	Free	0 - 255		
9	Lamp Power	0 - 24	0	Powered at 100%
		25 - 49		Powered at 95%
		50 - 74		Powered at 90%
		75 - 99		Powered at 85%
		100 - 124		Powered at 80%
		125 - 149		Powered at 75%
		150 - 174		Powered at 70%
		175 - 199		Powered at 65%
		200 - 224		Powered at 60%
		225 - 255		Powered at 55%
10	Free	0 - 255		

## D.3 DMX chart, Extended

### Overview

Channel	Function	Value	Default	Actions
1	Intensity	0 - 5	255	Mechanical shutter closed
		6 - 255		Electronic contrast on output
2	Brightness	0 - 255	128	Adjusts the brightness between 0 and 100% on input
3	Contrast	0 - 255	128	Adjusts the contrast between 0 and 100% on input

Channel	Function	Value	Default	Actions
4	Input selection	0 - 87	0	No function
		88 - 95		Input 1 (if held for 2 seconds)
		96 - 103		Input 2 (if held for 2 seconds)
		104 - 111		Input 3 (if held for 2 seconds)
		112 - 119		Input 4 (if held for 2 seconds)
		120 - 255		No function
5	Lens control	0 - 7	0	No function
		8 - 15		Lens shift Right
		16 - 23		No function
		24 - 31		Lens shift Left
		32 - 39		No function
		40 - 47		Lens shift up
		48 - 55		No function
		56 - 63		Lens shift down
		64 - 231		No function
		232 - 239		Return lens to center (if held for 5 seconds)
		240 - 247		Calibrate lens zoom + focus (if held for 5 seconds)
		248 - 255		No function
6	Focus (MSB)	0 - 255	128	Coarse lens focus adjustment <sup>15</sup>
7	Focus (LSB)	0 - 255	128	Fine lens focus adjustment <sup>15</sup>
8	Zoom (MSB)	0 - 255	128	Coarse lens zoom adjustment <sup>15</sup>
9	Zoom (LSB)	0 - 255	128	Fine lens zoom adjustment <sup>15</sup>
10	Lamp Control	0 - 7	0	Lamp power 100%
		8 - 15		Lamp power 95%
		16 - 23		Lamp power 90%
		24 - 31		Lamp power 85%
		32 - 39		Lamp power 80%
		40 - 47		Lamp power 75%
		48 - 55		Lamp power 70%
		56 - 63		Lamp power 65%
		64 - 71		Lamp power 60%
		72 - 79		Lamp power 55%
		80 - 207		No function
		208 - 215		Power On / Lamp On (If held for 5 seconds)
		216 - 223		Stand by / Lamp Off (if held for 5 seconds)
		224 - 231		XLR output voltage On (if held for 5 seconds)
		232 - 239		XLR output voltage Off (if held for 5 seconds)
240 - 255	No function			

15. Only when lens is calibrated



## E. STACKING HDF SERIES PROJECTORS

### General

Three interlocking adapters at the top and at the bottom of the HDF series projector allows an easy and fast stacking without using extra tools or accessories.



**WARNING:** Maximum stack three (3) HDF series projectors in a table mount configuration.

Maximum stack two (2) HDF series projectors in a ceiling mount configuration.

### Overview

- Stacking HDF series projectors
- Aligning stacked HDF series projectors

### E.1 Stacking HDF series projectors

#### How to stack HDF series projectors ?

1. Turn in the four feet of the projector you want to stack.
2. Place the projectors on top of each other. Ensure that all three interlocking pins (A) match with their corresponding interlocking sockets (B).

**Tip:** In case of stacking projectors for a ceiling mount configuration, first turn the projectors upside down before placing the projectors on top of each other.

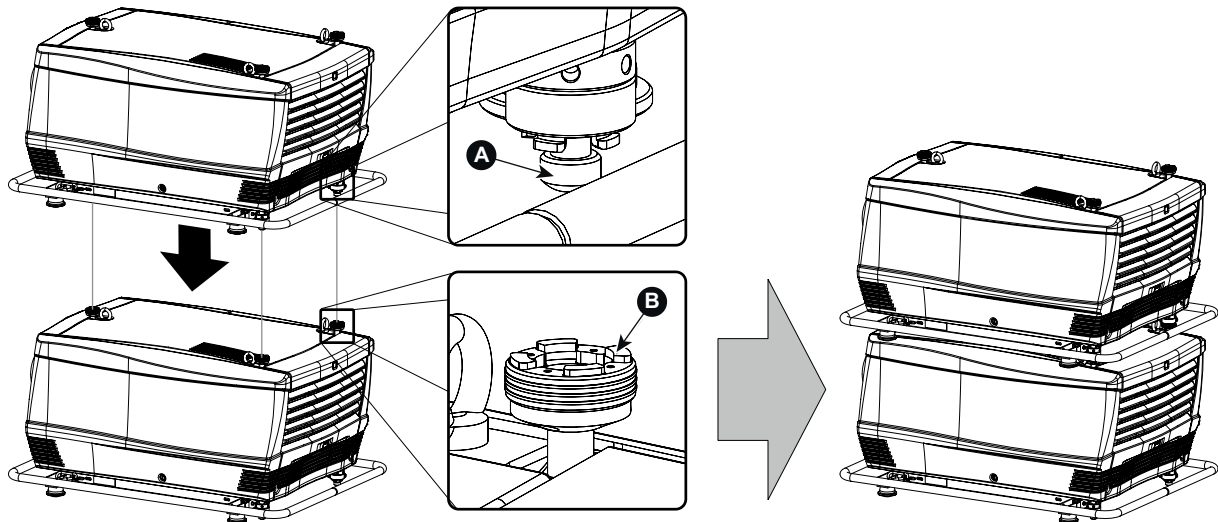


Image E-1

3. Attach the two projectors together by closing all three interlocking adapters as illustrated.

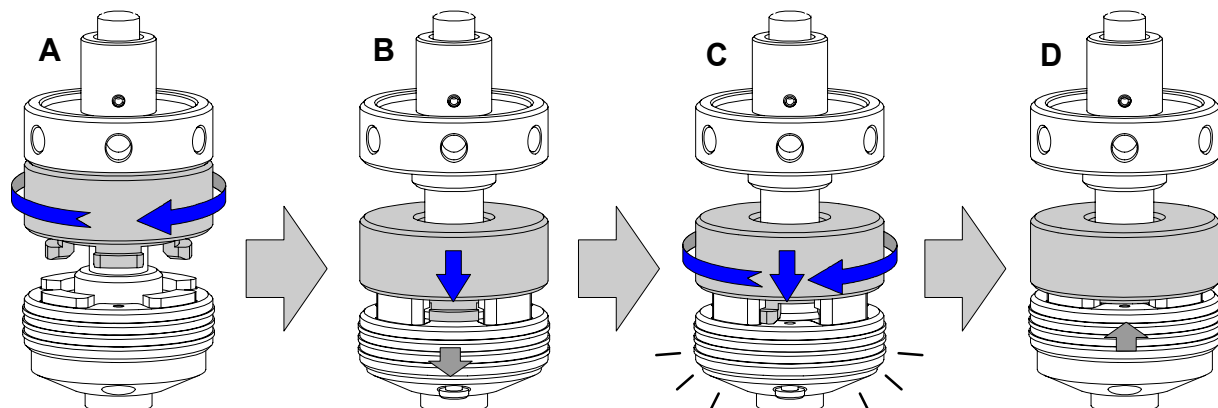


Image E-2  
Closing interlocking adapter

## E. Stacking HDF series projectors

### 4. Are these projectors stacked for a ceiling mount configuration?

If yes, secure the projectors with safety chains as follows:

- a) Release the safety hook (H) at both sides of the lowest projector and guide the safety cable around its carrying handle (C) as illustrated.

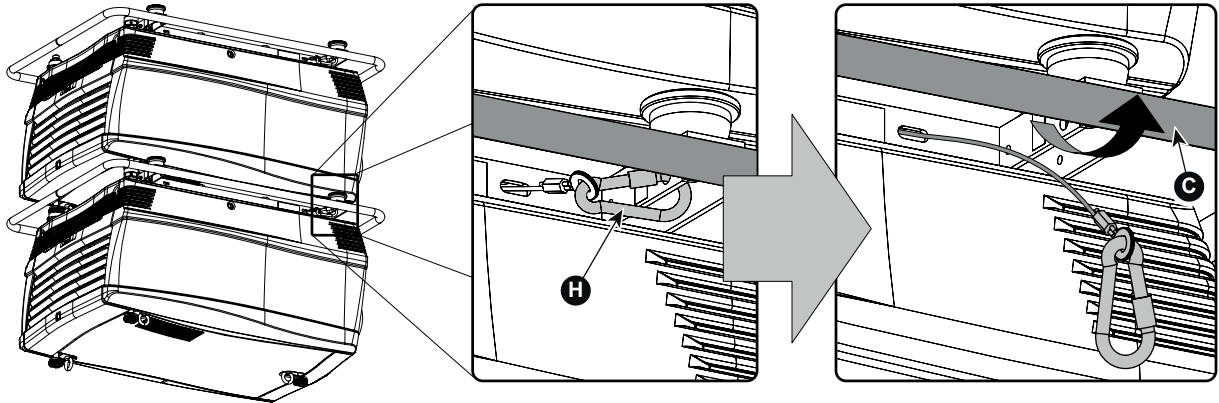


Image E-3  
Safety cable

- b) Guide the safety cable around the carrying handle of the projector above and clasp the safety hook around the safety cable as illustrated.

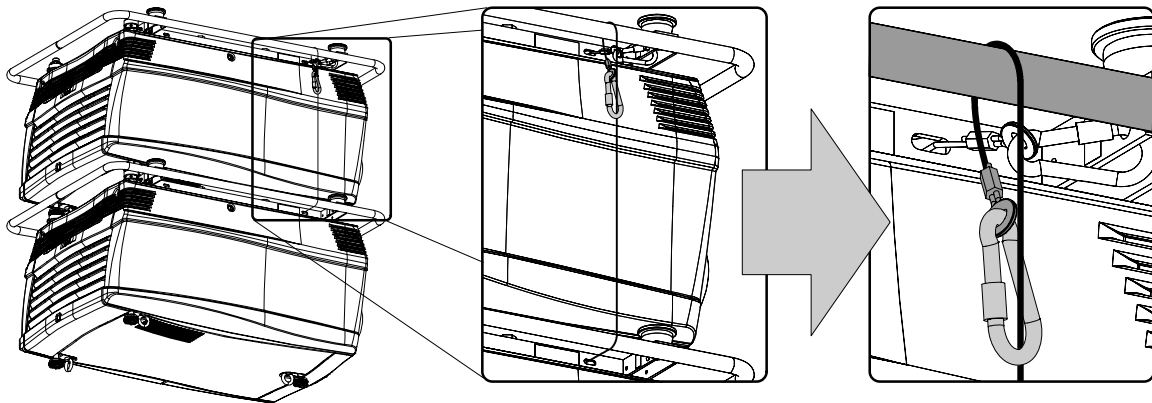


Image E-4  
Mount safety cable



**WARNING:** Always use both safety cables of the lowest projector to secure a stacked projector in a ceiling mount configuration.



**WARNING:** Always mount a safety chain around the truss and the first projector in that way that projector cannot drop more than 20 cm.

### How to open an interlocking adapter ?

1. Open an interlocking adaptor as illustrated.

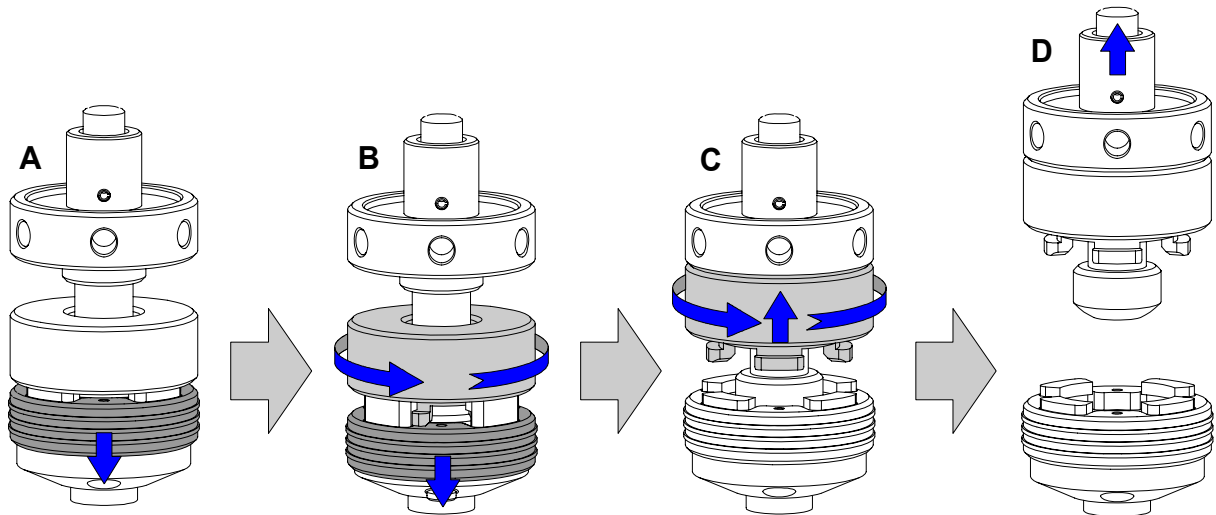


Image E-5  
Opening interlocking adapter



**WARNING:** Never open an interlocking adapter of a stacked projector which is still suspended. First place the stacked projectors on the floor.

## E.2 Aligning stacked HDF series projectors

### Necessary tools

8 mm Allen key.

### How to align two stacked HDF series projectors ?

1. Make sure that the internal hatch pattern projected by the reference projector is sharp and has a perfect rectangle outline. If this is not the case, readjust the reference projector before aligning the other stacked projector(s) with the reference hatch pattern.  
**Note:** The reference projector in a stacked configuration is the lowest projector in case of table mount and the uppermost projector in case of ceiling mount.
2. Project with the stacked projector the same internal hatch pattern as the reference projector.  
**Tip:** Use a white colored hatch pattern for the reference projector and e.g. green colored for the stacked projector. This makes it easier to see the difference between both hatch patterns projected.
3. If necessary, adjust the rotation of the stacked projector with respect to the reference projector by turning in or out the height adjustment ring of the interlocking adapters at the rear of the stacked projector. Adjust until the outline of the hatch pattern is most symmetric with the reference hatch pattern.  
**Tip:** You can increase leverage by using a screw driver in the holes of the adjustment ring

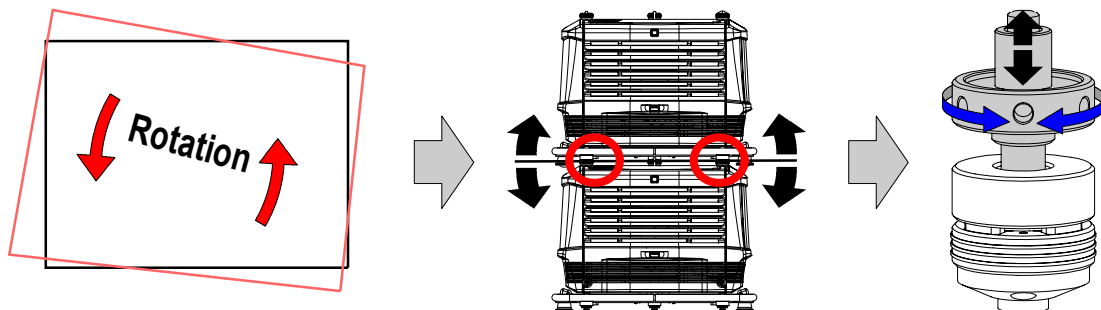


Image E-6  
Rotation adjustment

4. If necessary, adjust the inclination of the stacked projector with respect to the reference projector by turning the height adjustment ring of the interlocking adaptor at the front of the stacked projector in or out. Adjust until the outline of the hatch pattern is most symmetric with the reference hatch pattern.

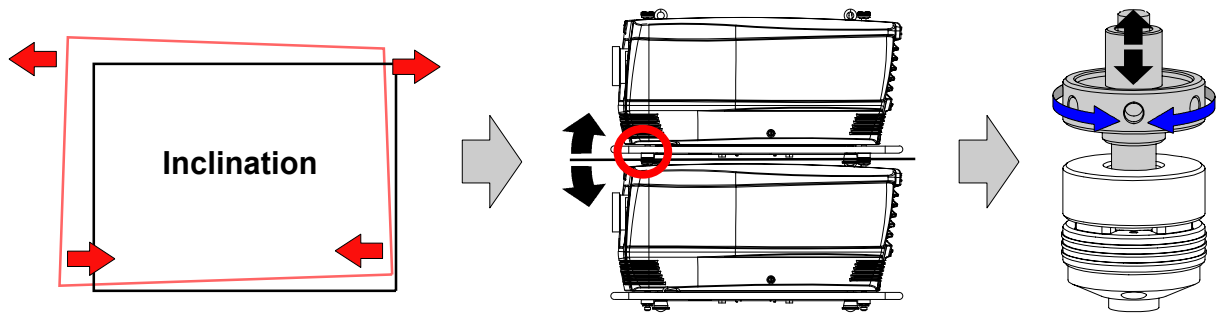


Image E-7  
Inclination adjustment

5. If necessary, adjust the skew of the stacked projector with respect to the reference projector by turning the screw Q in or out using a 8 mm Allen key. The screw Q is located behind the cover of the lamp, just above the volt meter. Adjust until the outline of the hatch pattern is most symmetric with the reference hatch pattern.

**Note:** See procedure "Removal of the lamp cover", to access the skew adjustment screw Q.

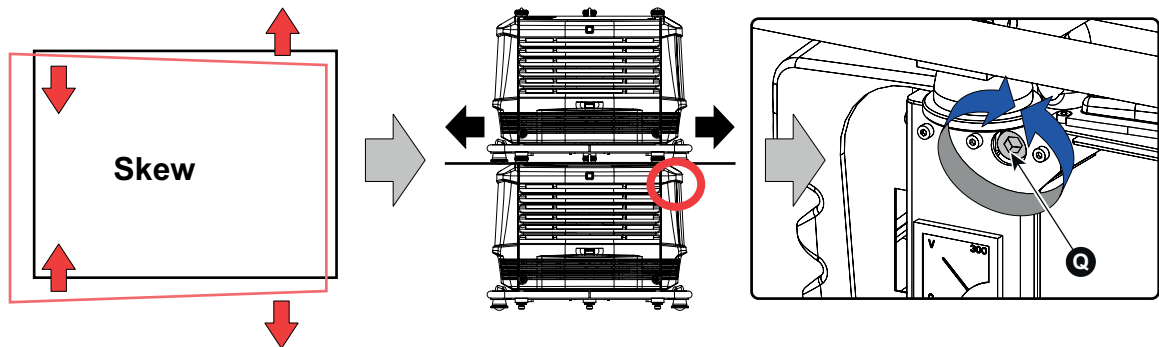


Image E-8  
Skew adjustment

6. Shift the hatch pattern horizontally and vertically until the outline of the hatch pattern is most symmetrically placed with respect to the reference hatch pattern.

**Note:** Note that the "Shift" function is motorized, which means that you have to access the projector software, via the local keypad or remote control unit, to operate the "Shift" function.

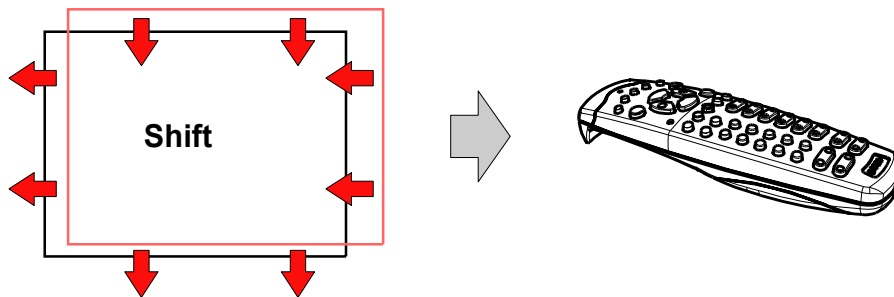


Image E-9  
Shift adjustment

7. Zoom the hatch pattern in or out until the outline of the hatch pattern matches exactly the outline of the reference hatch pattern.

**Note:** Note that the "Zoom" function is motorized, which means that you have to access the projector software, via the local keypad or remote control unit, to operate the "Zoom" function.

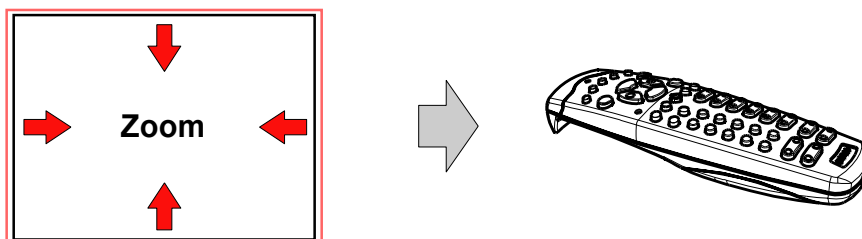


Image E-10  
Zoom adjustment

8. If necessary, repeat from step 2 until the hatch pattern of the stacked projector is perfectly aligned with the hatch pattern of the reference projector.





**In case of a triple stacked table mount projector configuration adjust and align first the bottommost projector (reference), than the projector in the middle and finally the uppermost projector.**

---



## F. ENVIRONMENTAL INFORMATION

### Overview

- Disposal information
- Rohs compliance
- Production address
- Importers contact information

### F.1 Disposal information

#### Disposal Information

Waste Electrical and Electronic Equipment



■ This symbol on the product indicates that, under the European Directive 2012/19/EU governing waste from electrical and electronic equipment, this product must not be disposed of with other municipal waste. Please dispose of your waste equipment by handing it over to a designated collection point for the recycling of waste electrical and electronic equipment. To prevent possible harm to the environment or human health from uncontrolled waste disposal, please separate these items from other types of waste and recycle them responsibly to promote the sustainable reuse of material resources.

For more information about recycling of this product, please contact your local city office or your municipal waste disposal service.

For details, please visit the Barco website at: <http://www.barco.com/en/AboutBarco/weee>

#### Disposal of batteries in the product



■ This product contains batteries covered by the Directive 2006/66/EC which must be collected and disposed of separately from municipal waste.

If the battery contains more than the specified values of lead (Pb), mercury (Hg) or cadmium (Cd), these chemical symbols will appear below the crossed-out wheeled bin symbol.

By participating in separate collection of batteries, you will help to ensure proper disposal and to prevent potential negative effects on the environment and human health.

#### Disposal of lamp

Dispose of expired bulbs that are beyond warranty in the following manner: wrap the bulb tightly in several layers of canvas or heavy cloth. Place it on hard surface and shatter the envelope with a sharp hammer blow. DO NOT place a non shattered bulb in any ordinary refuse container.

Small amounts of radioactive material (< 1000 Bq per lamp) are deliberately added to Xenon lamps for functional reasons. These lamps are manufactured under regulatory control as consumer product according to IAEA basic safety standard BSS 115. Disposal according to national regulations is required e.g. in Europe covered by WEEE regulation. See also related user manual of the lamp supplier for more guidance.

### F.2 Rohs compliance

#### 中国大陆 RoHS (Information for China ROHS compliance)

根据中国大陆《电子信息产品污染控制管理办法》(也称为中国大陆 RoHS), 以下部份列出了本产品中可能包含的有毒有害物质或元素的名称和含量。



F. Environmental information

Table of toxic and hazardous substances/elements and their content, as required by China's management methods for controlling pollution by electronic information products

零件项目(名称) Component name	有毒有害物质或元素 Hazardous substances and elements					
	铅 Pb	汞 Hg	镉 Cd	六价铬 Cr6+	多溴联苯 PBB	多溴二苯醚 PBDE
印制电路配件 Printed Circuit Assemblies	0	0	0	0	0	0
插入式插件 Plug assembly	0	0	0	0	0	0
外接电(线)缆 External Cables	0	0	0	0	0	0
内部线路 Internal wiring	0	0	0	0	0	0
散热片(器) Heatsinks	0	0	0	0	0	0
光学镜头 Optical lenses	x	0	0	0	0	0
底架 Chassis	0	0	0	0	0	0
外壳 Enclosure	0	0	0	0	0	0
螺帽,螺钉(栓),螺旋(钉),垫圈,紧固件 Nuts, bolts, screws, washers, Fasteners	0	0	0	0	0	0
电源供应器 Power Supply Unit	0	0	0	0	0	0
风扇 Fan	0	0	0	0	0	0
键盘 Keyboard	0	0	0	0	0	0
显示(器) Display	0	0	0	0	0	0
正面(前)面板 Front panel	0	0	0	0	0	0
金属制品[制造] Metalwork	0	0	0	0	0	0
塑胶制品[制造] Plastic work	0	0	0	0	0	0
电池(组) Batteries	0	0	0	0	0	0
文件说明书 Paper Manuals	0	0	0	0	0	0
光盘说明书 CD Manual	0	0	0	0	0	0
装置配件 Installation kit	0	0	0	0	0	0
O: 表示该有毒有害物质在该部件所有均质材料中的含量均在 SJ/T 11363-2006 标准规定的限量要求以下。 O: Indicates that this toxic or hazardous substance contained in all of the homogeneous materials for this part is below the limit requirement in SJ/T11363-2006.						
X: 表示该有毒有害物质至少在该部件的某一均质材料中的含量超出 SJ/T 11363-2006 标准规定的限量要求。 X: Indicates that this toxic or hazardous substance contained in at least one of the homogeneous materials used for this part is above the limit requirement in SJ/T11363-2006						

### Turkey RoHS compliance



■ Türkiye Cumhuriyeti: AEEE Yönetmeliğine Uygundur.

[Republic of Turkey: In conformity with the WEEE Regulation]

## F.3 Production address

---

### Factories

#### Barco NV

Noordlaan 5, B-8520 Kuurne (BELGIUM)

Barco Visual (Beijing) Electronics Co. Ltd.

巴可伟视(北京)电子有限公司

No.16 Changsheng Road, Changping District, 102200, Beijing, P.R.C

北京市昌平区中关村科技园区昌平园昌盛路16号 邮政编码: 102200

### Made in information

The made in country is indicated on the product ID label on the product itself.

### Production date

The month and year of production is indicated on the product ID label on the product itself.

## F.4 Importers contact information

---

### Contact

To find your local importer, contact Barco directly or one of Barco's regional offices via the contact information given on Barco's web site, [www.barco.com](http://www.barco.com).



## Revision Sheet

To:

► **Barco nv/Documentation**  
Noordlaan 5, B-8520 Kuurne  
Phone: +32 56.36.82.11, Fax: +32 56.36.88.24  
Support: [www.Barco.com/esupport](http://www.Barco.com/esupport), Web: [www.barco.com](http://www.barco.com)

From: \_\_\_\_\_

Date: \_\_\_\_\_

Please correct the following points in this documentation (**R5905158/07**):

page	wrong	correct